

CP 155/CP 155-LS

CP 155/CP 155-LS



REYNAERS
aluminium

Cat. nr. 34
Art. nr. AD.A89.C34E.00
Edition 03/2019

Inhoud
Sommaire
Content
Inhalt



D Doorsnedetekeningen
 Sections des noeuds
 Section drawings
 Profilkombinationen



Inhoud

INHOUDSTAFEL 34.001-008

Doorsnedetekeningen

| | |
|---|--------------|
| OPENGAANDE ELEMENTEN (MONORAIL) - BUITENKADEF | 34.D.001 |
| SYSTEEMOVERZICHT | 34.D.002-004 |
| OVERZICHT INBRAAKWEREND | 34.D.005-006 |
| SYSTEEMOVERZICHT - ISOLATIE | 34.D.007-013 |
| OPENGAANDE ELEMENTEN (DUORAIL) - BUITENKADERS | 34.D.014-021 |
| OPENGAANDE ELEMENTEN (MONORAIL) - BUITENKADEF | 34.D.022-025 |
| OPENGAANDE ELEMENTEN (MONORAIL) - BUITENBEGLA | 34.D.026-028 |
| OPENGAANDE ELEMENTEN (3-RAIL) - BUITENKADERS | 34.D.029-035 |
| KOPPELINGEN BINNEN HET SYSTEEM - BUITENKADERS | 34.D.036-037 |
| OPENGAANDE ELEMENTEN (DUORAIL) - BUITENKADERS | 34.D.038-040 |
| OPENGAANDE ELEMENTEN (DUORAIL) - FLAT BOTTOM | 34.D.041 |
| OPENGAANDE ELEMENTEN (DUORAIL) - BUITENKADERS | 34.D.042-047 |
| OPENGAANDE ELEMENTEN (DUORAIL) - AUTOMATISCHE | 34.D.048 |
| OPENGAANDE ELEMENTEN (MONORAIL) - BUITENKADEF | 34.D.049-052 |
| OPENGAANDE ELEMENTEN (MONORAIL) - BUITENBEGLA | 34.D.053-056 |
| OPENGAANDE ELEMENTEN (3-RAIL) - BUITENKADERS | 34.D.057-064 |
| OPENGAANDE ELEMENTEN (MULTI-RAIL) - BUITENKADEF | 34.D.065-067 |
| OPENGAANDE ELEMENTEN (ZERO THRESHOLD) - BUIE | 34.D.068-070 |
| OPENGAANDE ELEMENTEN (DUORAIL) - POCKET | 34.D.071 |
| OPENGAANDE ELEMENTEN (3-RAIL) - POCKET | 34.D.072 |
| OPENGAANDE ELEMENTEN (MULTI-RAIL) - POCKET | 34.D.073 |
| KOPPELINGEN BINNEN HET SYSTEEM - BUITENKADERS | 34.D.074-075 |
| OPENGAANDE ELEMENTEN (MONORAIL) - MINERGIE | 34.D.076-079 |
| OPENGAANDE ELEMENTEN (DUORAIL) - BUITENKADERS | 34.D.080-083 |
| OPENGAANDE ELEMENTEN (MONORAIL) - BUITENKADEF | 34.D.084-085 |
| OPENGAANDE ELEMENTEN (DUORAIL) - BUITENKADERS | 34.D.086-087 |
| OPENGAANDE ELEMENTEN (MONORAIL) - BUITENKADEF | 34.D.088-090 |
| SYSTEEMOVERZICHT | 34.D.091 |
| KOPPELINGEN MET ANDERE SYSTEMEN - CS 68 - CS 77 | 34.D.092 |
| KOPPELINGEN MET ANDERE SYSTEMEN - CS 77 | 34.D.093 |
| KOPPELINGEN MET ANDERE SYSTEMEN - SL 38 | 34.D.094 |
| KOPPELINGEN MET ANDERE SYSTEMEN - MASTERLINE | 34.D.095-096 |
| KOPPELINGEN MET ANDERE SYSTEMEN - MASTERLINE | 34.D.097 |
| KOPPELINGEN MET ANDERE SYSTEMEN - CW 50 | 34.D.098 |



Sommaire

| | |
|--------------------|------------|
| TABLE DES MATIERES | 34.001-008 |
|--------------------|------------|

Sections des noeuds

| | |
|--|--------------|
| ELEMENTS OUVRANTS (MONORAIL) - DORMANTS | 34.D.001 |
| APERCU DU SYSTEME | 34.D.002-004 |
| APERCU PROTECTION ANTI-VOL | 34.D.005-006 |
| APERCU DU SYSTEME - ISOLATION | 34.D.007-013 |
| ELEMENTS OUVRANTS (DUORAIL) - DORMANTS | 34.D.014-021 |
| ELEMENTS OUVRANTS (MONORAIL) - DORMANTS | 34.D.022-025 |
| ELEMENTS OUVRANTS (MONORAIL) - VITRAGE EXTERIE | 34.D.026-028 |
| ELEMENTS OUVRANTS (3-RAIL) - DORMANTS | 34.D.029-035 |
| COMBINAISONS DANS LE SYSTEME - DORMANTS | 34.D.036-037 |
| ELEMENTS OUVRANTS (DUORAIL) - DORMANTS | 34.D.038-040 |
| ELEMENTS OUVRANTS (DUORAIL) - FLAT BOTTOM | 34.D.041 |
| ELEMENTS OUVRANTS (DUORAIL) - DORMANTS | 34.D.042-047 |
| ELEMENTS OUVRANTS (DUORAIL) - SOULEV. COULISSAN | 34.D.048 |
| ELEMENTS OUVRANTS (MONORAIL) - DORMANTS | 34.D.049-052 |
| ELEMENTS OUVRANTS (MONORAIL) - VITRAGE EXTERIE | 34.D.053-056 |
| ELEMENTS OUVRANTS (3-RAIL) - DORMANTS | 34.D.057-064 |
| ELEMENTS OUVRANTS (MULTI-RAIL) - DORMANTS | 34.D.065-067 |
| ELEMENTS OUVRANTS (ZERO THRESHOLD) - DORMANT | 34.D.068-070 |
| ELEMENTS OUVRANTS (DUORAIL) - POCKET | 34.D.071 |
| ELEMENTS OUVRANTS (3-RAIL) - POCKET | 34.D.072 |
| ELEMENTS OUVRANTS (MULTI-RAIL) - POCKET | 34.D.073 |
| COMBINAISONS DANS LE SYSTEME - DORMANTS | 34.D.074-075 |
| ELEMENTS OUVRANTS (MONORAIL) - MINERGIE | 34.D.076-079 |
| ELEMENTS OUVRANTS (DUORAIL) - DORMANTS | 34.D.080-083 |
| ELEMENTS OUVRANTS (MONORAIL) - DORMANTS | 34.D.084-085 |
| ELEMENTS OUVRANTS (DUORAIL) - DORMANTS | 34.D.086-087 |
| ELEMENTS OUVRANTS (MONORAIL) - DORMANTS | 34.D.088-090 |
| APERCU DU SYSTEME | 34.D.091 |
| COMBINAISONS AVEC D'AUTRES SYSTEMES - CS 68 - CS | 34.D.092 |
| COMBINAISONS AVEC D'AUTRES SYSTEMES - CS 77 | 34.D.093 |
| COMBINAISONS AVEC D'AUTRES SYSTEMES - SL 38 | 34.D.094 |
| COMBINAISONS AVEC D'AUTRES SYSTEMES - MASTERLI | 34.D.095-096 |
| COMBINAISONS AVEC D'AUTRES SYSTEMES - MASTERLI | 34.D.097 |
| COMBINAISONS AVEC D'AUTRES SYSTEMES - CW 50 | 34.D.098 |



Content

| | |
|-------------------|------------|
| TABLE OF CONTENTS | 34.001-008 |
|-------------------|------------|

Section drawings

| | |
|---|--------------|
| OPENING ELEMENTS (MONORAIL) - OUTER FRAMES | 34.D.001 |
| SYSTEM OVERVIEW | 34.D.002-004 |
| OVERVIEW BURGLAR PROTECTION | 34.D.005-006 |
| SYSTEM OVERVIEW - INSULATION | 34.D.007-013 |
| OPENING ELEMENTS (DUORAIL) - OUTER FRAMES | 34.D.014-021 |
| OPENING ELEMENTS (MONORAIL) - OUTER FRAMES | 34.D.022-025 |
| OPENING ELEMENTS (MONORAIL) - OUTER GLAZING | 34.D.026-028 |
| OPENING ELEMENTS (3-RAIL) - OUTER FRAMES | 34.D.029-035 |
| CONNECTIONS WITHIN THE SYSTEM - OUTER FRAMES | 34.D.036-037 |
| OPENING ELEMENTS (DUORAIL) - OUTER FRAMES | 34.D.038-040 |
| OPENING ELEMENTS (DUORAIL) - FLAT BOTTOM | 34.D.041 |
| OPENING ELEMENTS (DUORAIL) - OUTER FRAMES | 34.D.042-047 |
| OPENING ELEMENTS (DUORAIL) - AUTOMATIC LIFT AND : | 34.D.048 |
| OPENING ELEMENTS (MONORAIL) - OUTER FRAMES | 34.D.049-052 |
| OPENING ELEMENTS (MONORAIL) - OUTER GLAZING | 34.D.053-056 |
| OPENING ELEMENTS (3-RAIL) - OUTER FRAMES | 34.D.057-064 |
| OPENING ELEMENTS (MULTI-RAIL) - OUTER FRAMES | 34.D.065-067 |
| OPENING ELEMENTS (ZERO THRESHOLD) - OUTER FRAM | 34.D.068-070 |
| OPENING ELEMENTS (DUORAIL) - POCKET | 34.D.071 |
| OPENING ELEMENTS (3-RAIL) - POCKET | 34.D.072 |
| OPENING ELEMENTS (MULTI-RAIL) - POCKET | 34.D.073 |
| CONNECTIONS WITHIN THE SYSTEM - OUTER FRAMES | 34.D.074-075 |
| OPENING ELEMENTS (MONORAIL) - MINERGIE | 34.D.076-079 |
| OPENING ELEMENTS (DUORAIL) - OUTER FRAMES | 34.D.080-083 |
| OPENING ELEMENTS (MONORAIL) - OUTER FRAMES | 34.D.084-085 |
| OPENING ELEMENTS (DUORAIL) - OUTER FRAMES | 34.D.086-087 |
| OPENING ELEMENTS (MONORAIL) - OUTER FRAMES | 34.D.088-090 |
| SYSTEM OVERVIEW | 34.D.091 |
| CONNECTIONS WITH OTHER SYSTEMS - CS 68 - CS 77 | 34.D.092 |
| CONNECTIONS WITH OTHER SYSTEMS - CS 77 | 34.D.093 |
| CONNECTIONS WITH OTHER SYSTEMS - SL 38 | 34.D.094 |
| CONNECTIONS WITH OTHER SYSTEMS - MASTERLINE 8 | 34.D.095-096 |
| CONNECTIONS WITH OTHER SYSTEMS - MASTERLINE 10 | 34.D.097 |
| CONNECTIONS WITH OTHER SYSTEMS - CW 50 | 34.D.098 |









Inhalt

INHALTSANGABE 34.001-008

Profilkombinationen

| | |
|---|--------------|
| OFFFNENDE ELEMENTE (MONORAIL) - BLENDRAHMEN | 34.D.001 |
| SYSTEMUEBERSICHT | 34.D.002-004 |
| UEBERSICHT EINBRUCHHEMMEND | 34.D.005-006 |
| SYSTEMUEBERSICHT - ISOLATION | 34.D.007-013 |
| OFFFNENDE ELEMENTE (DOURAIL) - BLENDRAHMEN | 34.D.014-021 |
| OFFFNENDE ELEMENTE (MONORAIL) - BLENDRAHMEN | 34.D.022-025 |
| OFFFNENDE ELEMENTE (MONORAIL) - AUSSENVERGLAS | 34.D.026-028 |
| OFFFNENDE ELEMENTE (3-RAIL) - BLENDRAHMEN | 34.D.029-035 |
| KOMBINATIONEN IN DEN SYSTEMEN - BLENDRAHMEN | 34.D.036-037 |
| OFFFNENDE ELEMENTE (DOURAIL) - BLENDRAHMEN | 34.D.038-040 |
| OFFFNENDE ELEMENTE (DOURAIL) - FLAT BOTTOM | 34.D.041 |
| OFFFNENDE ELEMENTE (DOURAIL) - BLENDRAHMEN | 34.D.042-047 |
| OFFFNENDE ELEMENTE (DOURAIL) - AUTOMATISCHE HE | 34.D.048 |
| OFFFNENDE ELEMENTE (MONORAIL) - BLENDRAHMEN | 34.D.049-052 |
| OFFFNENDE ELEMENTE (MONORAIL) - AUSSENVERGLAS | 34.D.053-056 |
| OFFFNENDE ELEMENTE (3-RAIL) - BLENDRAHMEN | 34.D.057-064 |
| OFFFNENDE ELEMENTE (MULTI-RAIL) - BLENDRAHMEN | 34.D.065-067 |
| OFFFNENDE ELEMENTE (ZERO THRESHOLD) - BLENDRA | 34.D.068-070 |
| OFFFNENDE ELEMENTE (DUORAIL) - POCKET | 34.D.071 |
| OFFFNENDE ELEMENTE (3-RAIL) - POCKET | 34.D.072 |
| OFFFNENDE ELEMENTE (MULTI-RAIL) - POCKET | 34.D.073 |
| KOMBINATIONEN IN DEN SYSTEMEN - BLENDRAHMEN | 34.D.074-075 |
| OFFFNENDE ELEMENTE (MONORAIL) - MINERGIE | 34.D.076-079 |
| OFFFNENDE ELEMENTE (DOURAIL) - BLENDRAHMEN | 34.D.080-083 |
| OFFFNENDE ELEMENTE (MONORAIL) - BLENDRAHMEN | 34.D.084-085 |
| OFFFNENDE ELEMENTE (DOURAIL) - BLENDRAHMEN | 34.D.086-087 |
| OFFFNENDE ELEMENTE (MONORAIL) - BLENDRAHMEN | 34.D.088-090 |
| SYSTEMUEBERSICHT | 34.D.091 |
| KOMBINATIONEN MIT ANDEREN SYSTEMEN - CS 68 - CS | 34.D.092 |
| KOMBINATIONEN MIT ANDEREN SYSTEMEN - CS 77 | 34.D.093 |
| KOMBINATIONEN MIT ANDEREN SYSTEMEN - SL 38 | 34.D.094 |
| KOMBINATIONEN MIT ANDEREN SYSTEMEN - MASTERLI | 34.D.095-096 |
| KOMBINATIONEN MIT ANDEREN SYSTEMEN - MASTERLI | 34.D.097 |
| KOMBINATIONEN MIT ANDEREN SYSTEMEN - CW 50 | 34.D.098 |

|  |  |  |  |  |  |
|---|---|---|---|---|---|
| 34.D.001 | 14/03/2019 | | 34.D.071 | 18/03/2019 | D3002914 |
| 34.D.002 | 18/03/2019 | D0085313 | 34.D.072 | 18/03/2019 | D3002923 |
| 34.D.003 | 18/03/2019 | D0085314 | 34.D.073 | 18/03/2019 | D3002925 |
| 34.D.004 | 18/03/2019 | D3003000 | 34.D.074 | 18/03/2019 | D0085269 |
| 34.D.005 | 18/03/2019 | D0085246 | 34.D.075 | 18/03/2019 | D0085270 |
| 34.D.006 | 18/03/2019 | D0091829 | 34.D.076 | 18/03/2019 | D0091938 |
| 34.D.007 | 18/03/2019 | D0085279 | 34.D.077 | 18/03/2019 | D0091952 |
| 34.D.008 | 18/03/2019 | D0085280 | 34.D.078 | 18/03/2019 | D0091954 |
| 34.D.009 | 18/03/2019 | D3003013 | 34.D.079 | 18/03/2019 | D0091936 |
| 34.D.010 | 18/03/2019 | D0085281 | 34.D.080 | 18/03/2019 | D0085248 |
| 34.D.011 | 18/03/2019 | D3003019 | 34.D.081 | 18/03/2019 | D0085249 |
| 34.D.012 | 18/03/2019 | D0085282 | 34.D.082 | 18/03/2019 | D0085247 |
| 34.D.013 | 18/03/2019 | D0091827 | 34.D.083 | 18/03/2019 | D3002916 |
| 34.D.014 | 18/03/2019 | D0085272 | 34.D.084 | 18/03/2019 | D3002960 |
| 34.D.015 | 18/03/2019 | D0085274 | 34.D.085 | 18/03/2019 | D3002913 |
| 34.D.016 | 18/03/2019 | D0085273 | 34.D.086 | 18/03/2019 | D0085252 |
| 34.D.017 | 18/03/2019 | D0085276 | 34.D.087 | 18/03/2019 | D0085251 |
| 34.D.018 | 18/03/2019 | D0091862 | 34.D.088 | 18/03/2019 | D3003032 |
| 34.D.019 | 18/03/2019 | D0085271 | 34.D.089 | 18/03/2019 | D3003033 |
| 34.D.020 | 18/03/2019 | D0085277 | 34.D.090 | 18/03/2019 | D3002915 |
| 34.D.021 | 18/03/2019 | D0085275 | 34.D.091 | 18/03/2019 | D0085315 |
| 34.D.022 | 18/03/2019 | D0085283 | 34.D.092 | 18/03/2019 | D0085294 |
| 34.D.023 | 18/03/2019 | D0085285 | 34.D.093 | 18/03/2019 | D0091957 |
| 34.D.024 | 18/03/2019 | D0091863 | 34.D.094 | 18/03/2019 | D3003222 |
| 34.D.025 | 18/03/2019 | D0085278 | 34.D.095 | 18/03/2019 | D3003014 |
| 34.D.026 | 18/03/2019 | D3003011 | 34.D.096 | 18/03/2019 | D3003020 |
| 34.D.027 | 18/03/2019 | D3003010 | 34.D.097 | 18/03/2019 | D3003214 |
| 34.D.028 | 18/03/2019 | D3003012 | 34.D.098 | 18/03/2019 | D0085295 |
| 34.D.029 | 18/03/2019 | D0085288 | 34.001 | | |
| 34.D.030 | 18/03/2019 | D0085289 | 34.003 | | |
| 34.D.031 | 18/03/2019 | D0085290 | 34.005 | | |
| 34.D.032 | 18/03/2019 | D0091870 | 34.007 | | |
| 34.D.033 | 18/03/2019 | D0085286 | | | |
| 34.D.034 | 18/03/2019 | D0085287 | | | |
| 34.D.035 | 18/03/2019 | D0091869 | | | |
| 34.D.036 | 18/03/2019 | D0085292 | | | |
| 34.D.037 | 18/03/2019 | D0085293 | | | |
| 34.D.038 | 18/03/2019 | D0085255 | | | |
| 34.D.039 | 18/03/2019 | D0085256 | | | |
| 34.D.040 | 18/03/2019 | D0085257 | | | |
| 34.D.041 | 18/03/2019 | D0085258 | | | |
| 34.D.042 | 18/03/2019 | D0091912 | | | |
| 34.D.043 | 18/03/2019 | D0091913 | | | |
| 34.D.044 | 18/03/2019 | D0085253 | | | |
| 34.D.045 | 18/03/2019 | D0085254 | | | |
| 34.D.046 | 18/03/2019 | D3002958 | | | |
| 34.D.047 | 18/03/2019 | D3002957 | | | |
| 34.D.048 | 18/03/2019 | D0091930 | | | |
| 34.D.049 | 18/03/2019 | D0085260 | | | |
| 34.D.050 | 18/03/2019 | D0085261 | | | |
| 34.D.051 | 18/03/2019 | D0085262 | | | |
| 34.D.052 | 18/03/2019 | D0085259 | | | |
| 34.D.053 | 18/03/2019 | D3002950 | | | |
| 34.D.054 | 18/03/2019 | D3002953 | | | |
| 34.D.055 | 18/03/2019 | D3002948 | | | |
| 34.D.056 | 18/03/2019 | D3002941 | | | |
| 34.D.057 | 18/03/2019 | D0085265 | | | |
| 34.D.058 | 18/03/2019 | D0091932 | | | |
| 34.D.059 | 18/03/2019 | D0085266 | | | |
| 34.D.060 | 18/03/2019 | D0085268 | | | |
| 34.D.061 | 18/03/2019 | D0091933 | | | |
| 34.D.062 | 18/03/2019 | D0085263 | | | |
| 34.D.063 | 18/03/2019 | D0085264 | | | |
| 34.D.064 | 18/03/2019 | D0091935 | | | |
| 34.D.065 | 18/03/2019 | D3002962 | | | |
| 34.D.066 | 18/03/2019 | D3002961 | | | |
| 34.D.067 | 18/03/2019 | D3002963 | | | |
| 34.D.068 | 18/03/2019 | D3002975 | | | |
| 34.D.069 | 18/03/2019 | D3002978 | | | |
| 34.D.070 | 18/03/2019 | D3002982 | | | |

D



Doorsnedetekeningen

Sections des noeuds

Section drawings

Profilkombinationen

CP 155-LS

OPENGAANDE ELEMENTEN (MONORAIL) - BUITENKADERS
ELEMENTS OUVRANTS (MONORAIL) - DORMANTS
OPENING ELEMENTS (MONORAIL) - OUTER FRAMES
OEFFNENDE ELEMENTE (MONORAIL) - BLENDRAHMEN



2-RAIL
 2-RAIL

2-RAIL
 2-RAIL

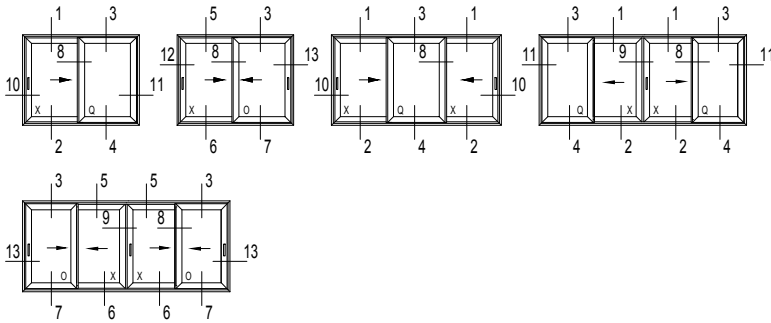

MONORAIL BINNENBEGLAZING
 MONORAIL VITRE PAR L'INTERIEUR

MONORAIL INSIDE GLAZED
 MONORAIL INNENVERGLASUNG

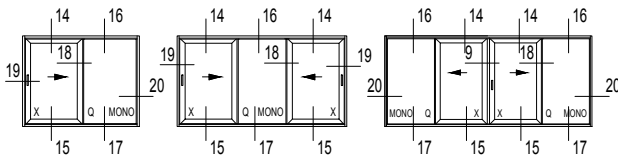

MONORAIL BUITENBEGLAZING
 MONORAIL INVERSION PARCLOSE

MONORAIL OUTSIDE GLAZED
 MONORAIL AUSSENVERGLASUNG

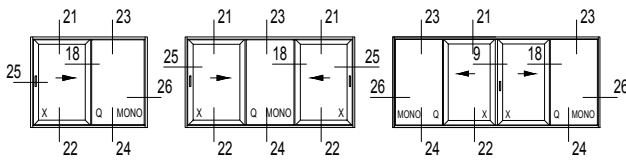

3-RAIL
 3-RAIL

3-RAIL
 3-RAIL

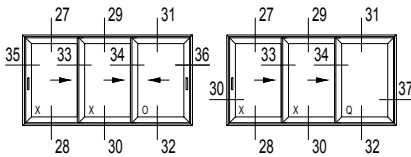

KOPPELINGEN BINNEN HET SYSTEEM
 COMBINAISONS DANS LE SYSTEME

CONNECTIONS WITHIN THE SYSTEM
 KOMBINATIONEN IM SYSTEM

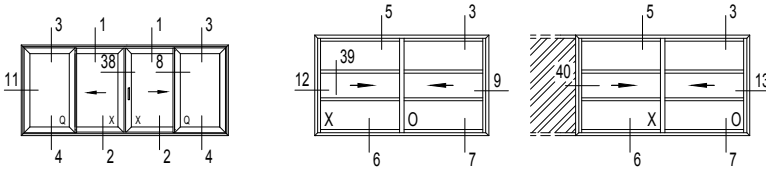

2-RAIL
 2-RAIL

2-RAIL
 2-RAIL

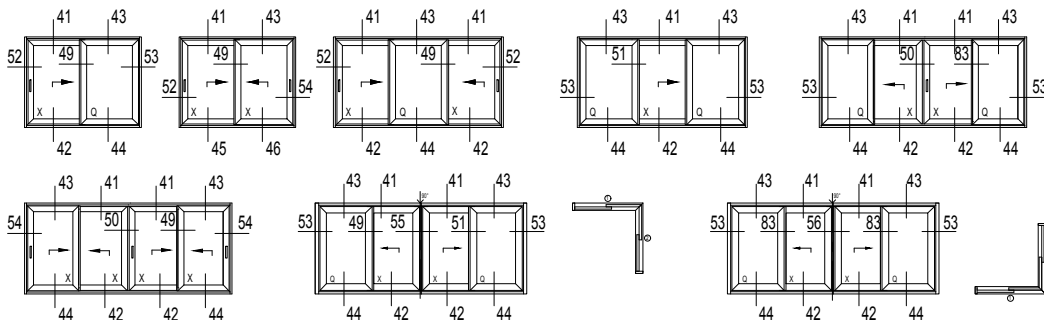

FLAT BOTTOM
 FLAT BOTTOM

FLAT BOTTOM
 FLAT BOTTOM

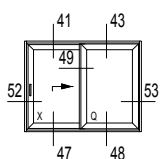

AUTOMATISCHE HEFSCHUIFDEUR
 SOULEV.COULISSANT AUTOMATIQUE

AUTOMATIC LIFT AND SLIDING DOOR
 AUTOMATISCHE HEBESCHIEBETUER

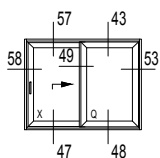

MONORAIL BINNENBEGLAZING
 MONORAIL VITRE PAR L'INTERIEUR

MONORAIL INSIDE GLAZED
 MONORAIL INNENVERGLASUNG

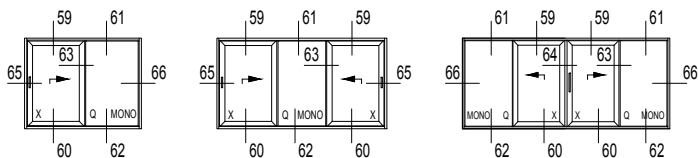

MONORAIL BUITENBEGLAZING
 MONORAIL INVERSION PARCLOSE

MONORAIL OUTSIDE GLAZED
 MONORAIL AUSSENVERGLASUNG

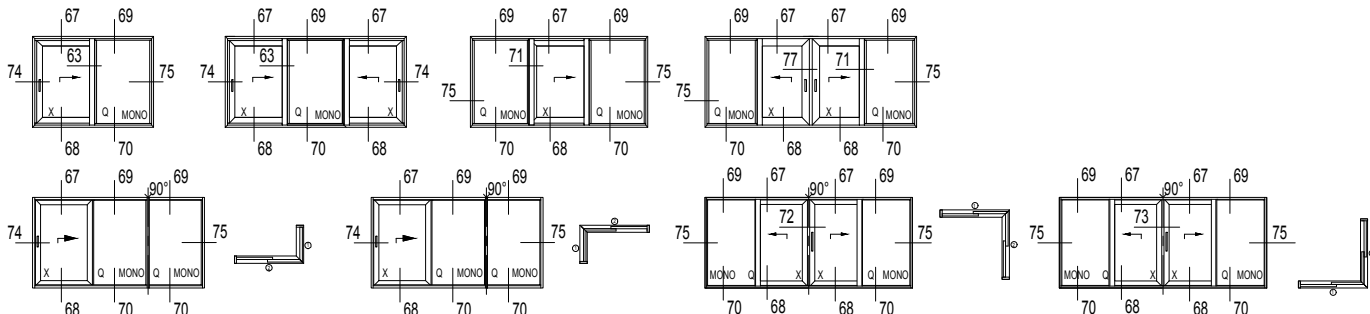

3-RAIL
 3-RAIL

3-RAIL
 3-RAIL

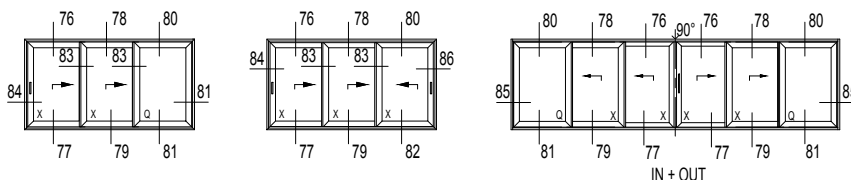

MULTIRAIL (MAX 8-RAIL)
 MULTIRAIL (MAX 8-RAIL)

MULTIRAIL (MAX 8-RAIL)
 MULTIRAIL (MAX 8-RAIL)

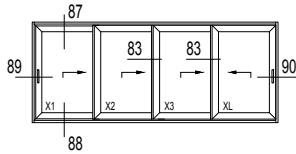

ZERO THRESHOLD (MAX 8-RAIL)
 ZERO THRESHOLD (MAX 8-RAIL)

ZERO THRESHOLD (MAX 8-RAIL)
 ZERO THRESHOLD (MAX 8-RAIL)

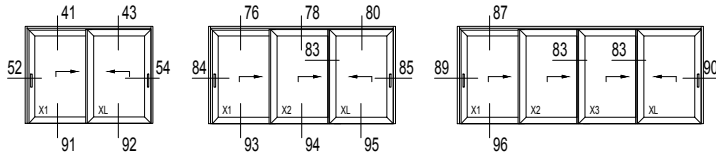

POCKET (MAX 8-RAIL)
 POCKET (MAX 8-RAIL)

POCKET (MAX 8-RAIL)
 POCKET (MAX 8-RAIL)

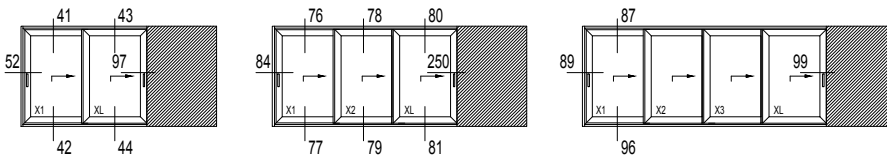

POCKET ZERO THRESHOLD (MAX 8-RAIL) POCKET ZERO THRESHOLD (MAX 8-RAIL)
 POCKET ZERO THRESHOLD (MAX 8-RAIL) POCKET ZERO THRESHOLD (MAX 8-RAIL)

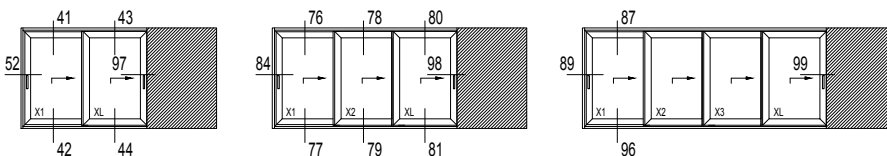

KOPPELINGEN BINNEN HET SYSTEM
 COMBINAISONS DANS LE SYSTEME

CONNECTIONS WITHIN THE SYSTEM
 KOMBINATIONEN IM SYSTEM

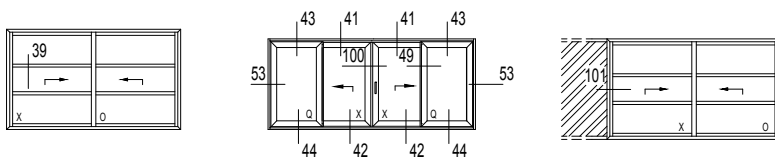

MONORAIL MINERGIE
 MONORAIL MINERGIE

MONORAIL MINERGIE
 MONORAIL MINERGIE

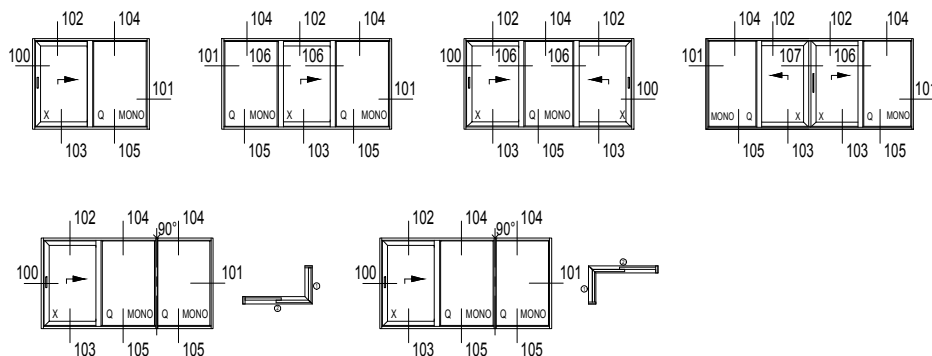

2-RAIL
2-RAIL

2-RAIL
2-RAIL

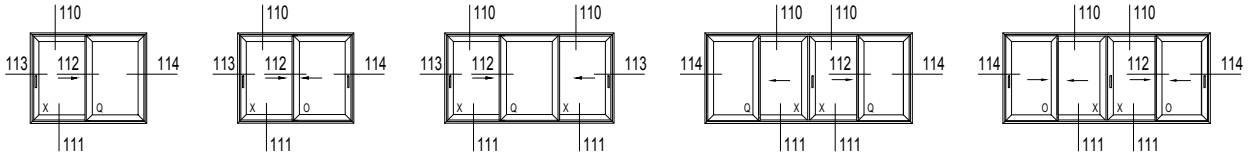

MONORAIL BINNENBEGLAZING
 MONORAIL VITRE PAR L'INTERIEUR

MONORAIL INSIDE GLAZED
 MONORAIL INNENVERGLASUNG

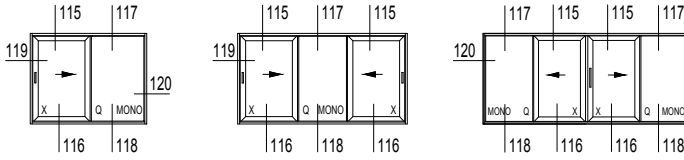

MONORAIL BUITENBEGLAZING
 MONORAIL INVERSION PARCLOSE

MONORAIL OUTSIDE GLAZED
 MONORAIL AUSSENVERGLASUNG

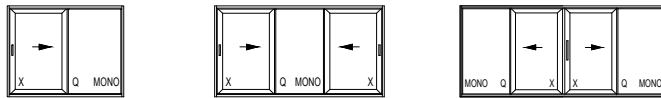

3-RAIL
3-RAIL

3-RAIL
3-RAIL

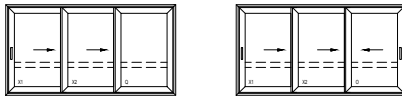

2-RAIL
 2-RAIL

2-RAIL
 2-RAIL

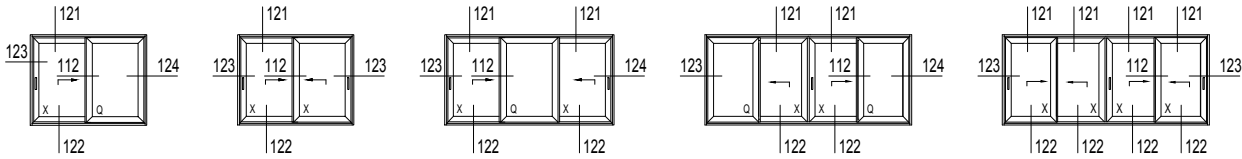

MONORAIL BINNENBEGLAZING
 MONORAIL VITRE PAR L'INTERIEUR

MONORAIL INSIDE GLAZED
 MONORAIL INNENVERGLASUNG

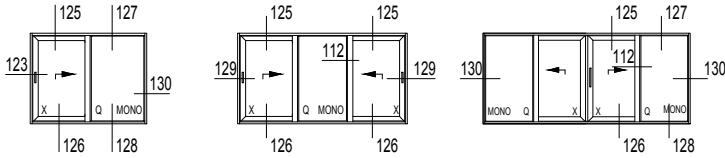

MONORAIL BUITENBEGLAZING
 MONORAIL INVERSION PARCLOSE

MONORAIL OUTSIDE GLAZED
 MONORAIL AUSSENVERGLASUNG

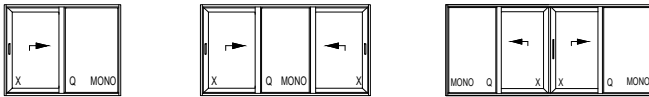

MONORAIL MINERGIE
 MONORAIL MINERGIE

MONORAIL MINERGIE
 MONORAIL MINERGIE

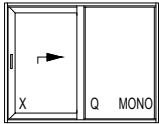

3-RAIL
 3-RAIL

3-RAIL
 3-RAIL

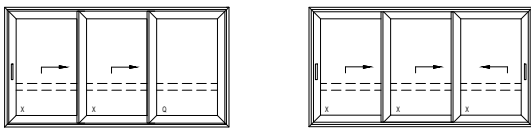

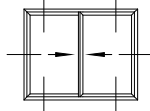
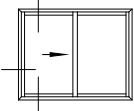

OPTIE A / OPTION A

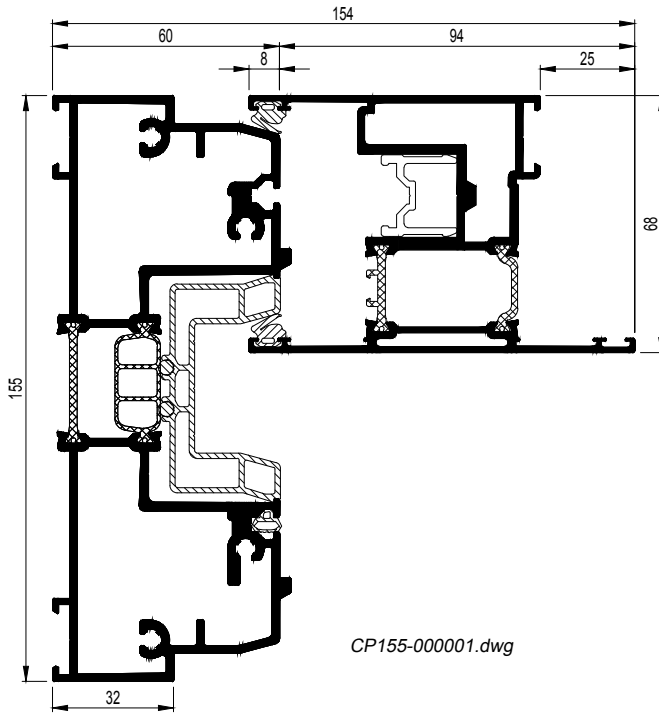

OPTIE C => HI / OPTION C => HI

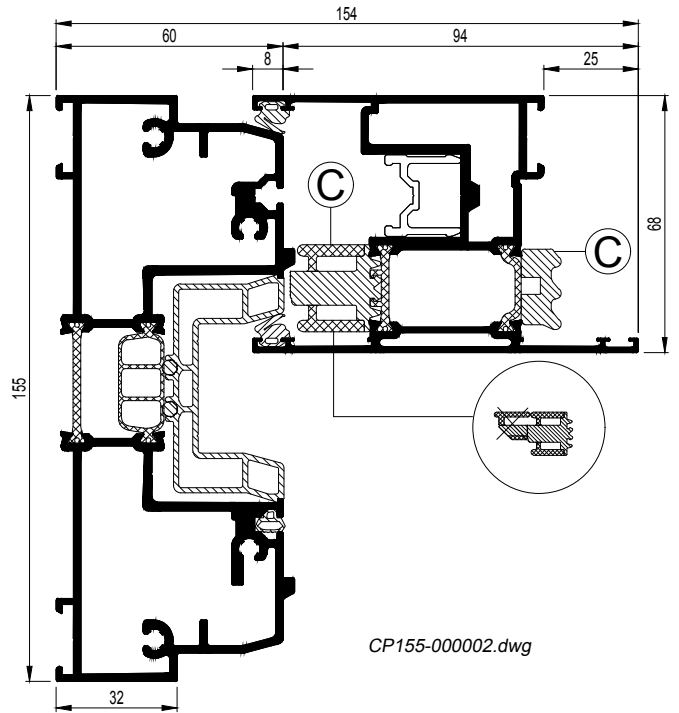

OPTIE B / OPTION B
 OPTIE B GETEKEND IN CATALOGUS
 OPTION B DESSINE DANS LE CATALOGUE
 OPTION B DRAWN IN CATALOGUE
 OPTION B GEZEICHENET IM KATALOG

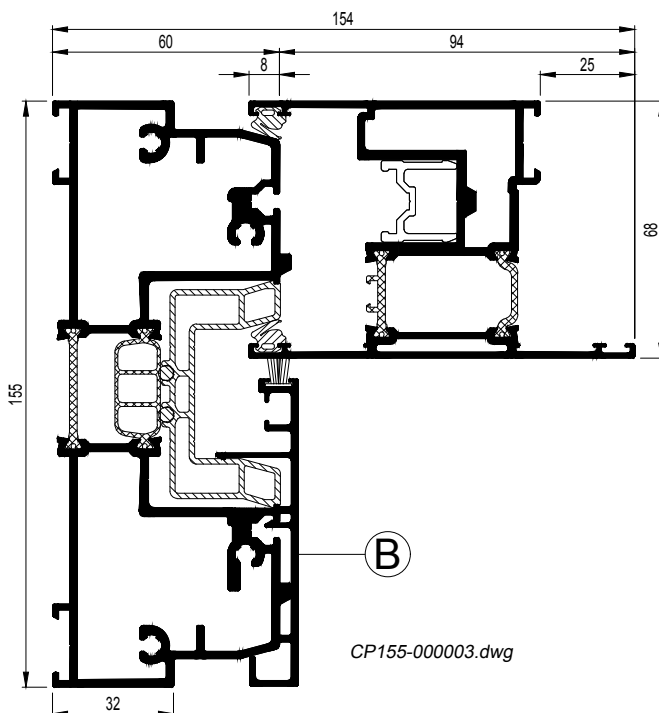

OPTIE D => HI / OPTION D => HI

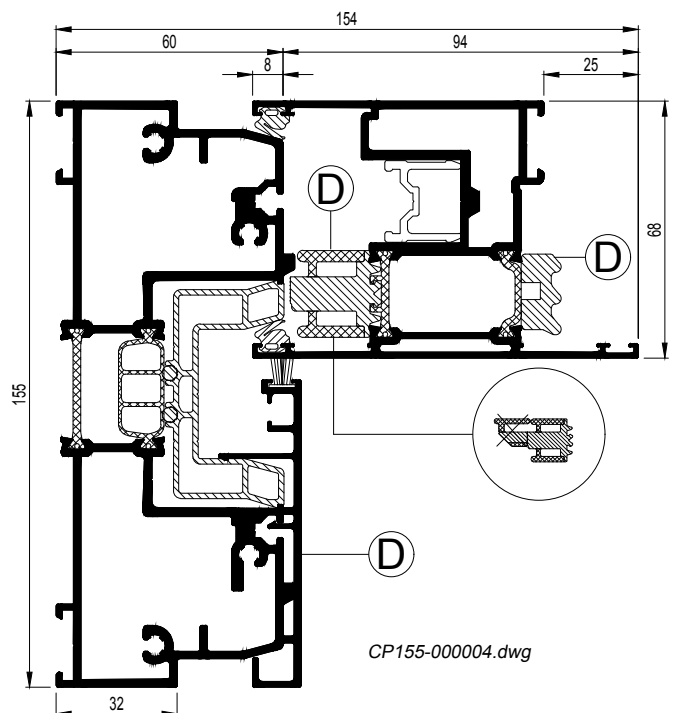

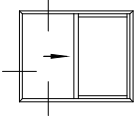

OPTIE A / OPTION A OPTIE A GETEKEND IN CATALOGUS
 OPTION A DESSINE DANS LE CATALOGUE
 OPTION A DRAWN IN CATALOGUE
 OPTION A GEZEICHENET IM KATALOG

OPTIE C => HI / OPTION C => HI

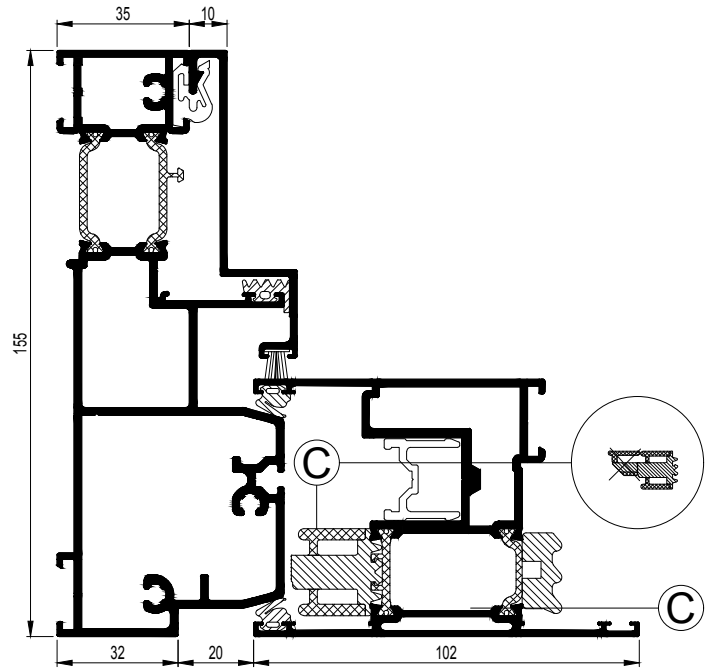
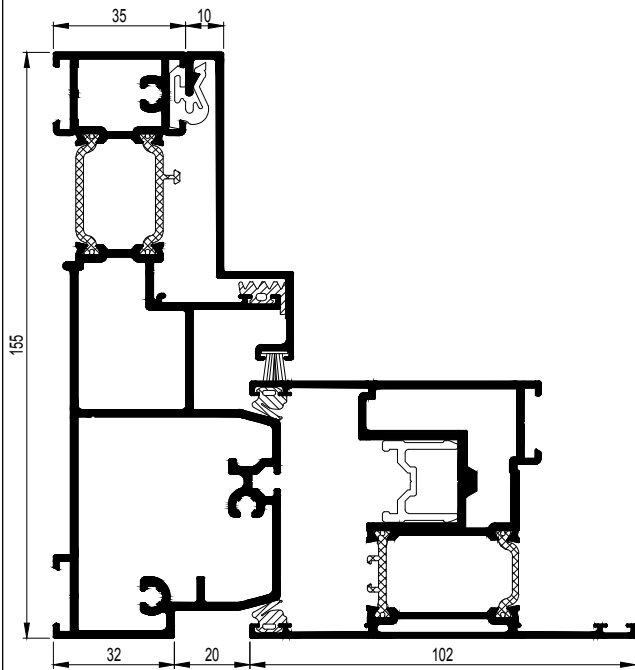

CP155-000005.dwg

CP155-000006.dwg

OPTIE A / OPTION A OPTIE A GETEKEND IN CATALOGUS
 OPTION A DESSINE DANS LE CATALOGUE
 OPTION A DRAWN IN CATALOGUE
 OPTION A GEZEICHENET IM KATALOG

OPTIE C => HI / OPTION C => HI

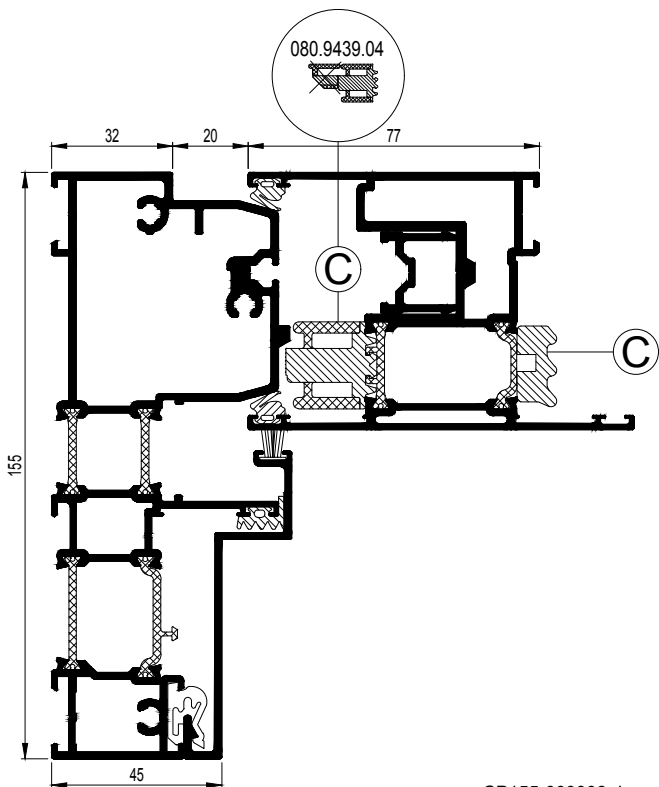
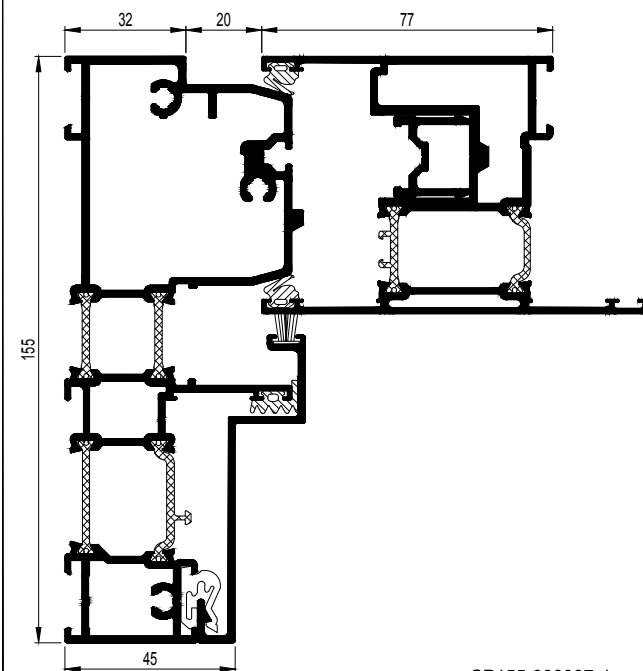

CP155-000007.dwg

CP155-000008.dwg

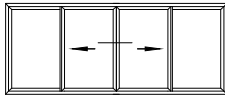
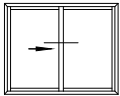

OPTIE A / OPTION A OPTIE A GETEKEND IN CATALOGUS
 OPTION A DESSINE DANS LE CATALOGUE
 OPTION A DRAWN IN CATALOGUE
 OPTION A GEZEICHENET IM KATALOG

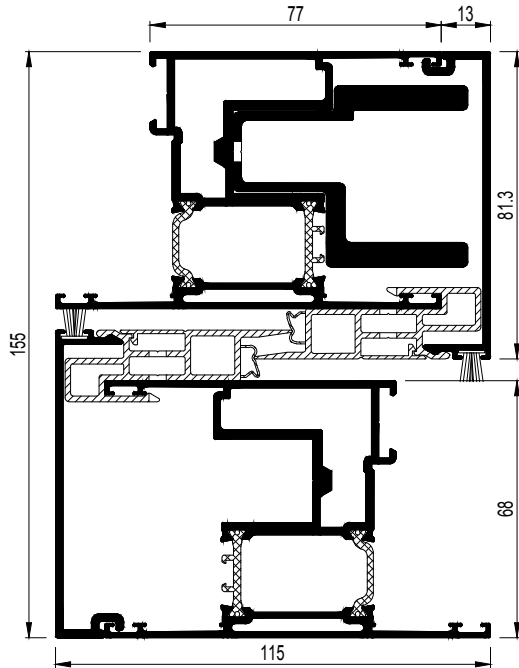

CP155-000009.dwg

OPTIE C => HI / OPTION C => HI

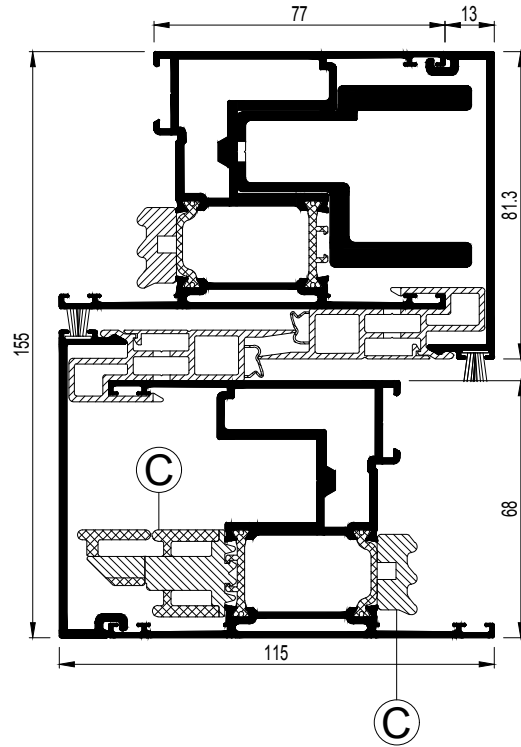

CP155-000010.dwg

OPTIE A / OPTION A OPTIE A GETEKEND IN CATALOGUS
 OPTION A DESSINE DANS LE CATALOGUE
 OPTION A DRAWN IN CATALOGUE
 OPTION A GEZEICHENET IM KATALOG

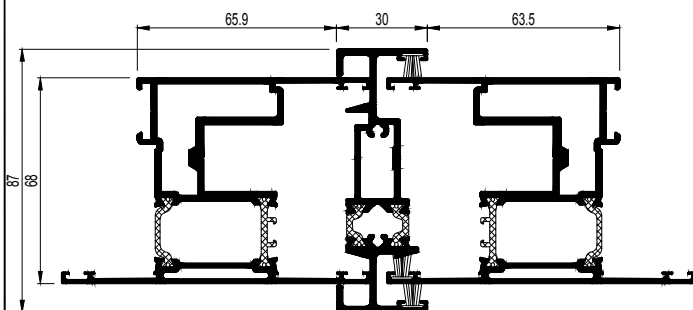

CP155-000011.dwg

OPTIE C => HI / OPTION C => HI

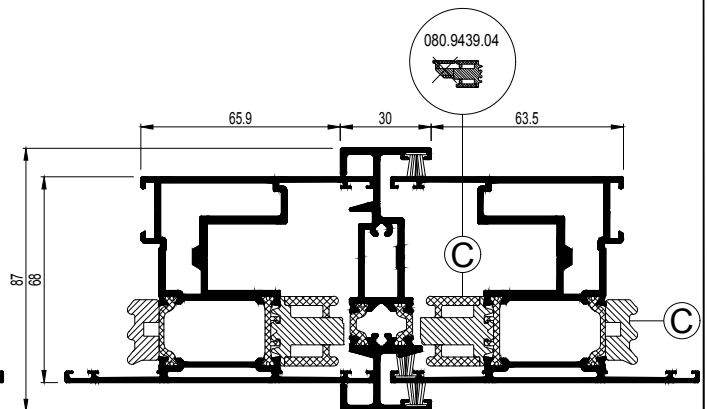

CP155-000012.dwg

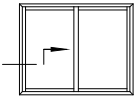

OPTIE A / OPTION A OPTIE A GETEKEND IN CATALOGUS
 OPTION A DESSINE DANS LE CATALOGUE
 OPTION A DRAWN IN CATALOGUE
 OPTION A GEZEICHENET IM KATALOG

OPTIE C => HI / OPTION C => HI

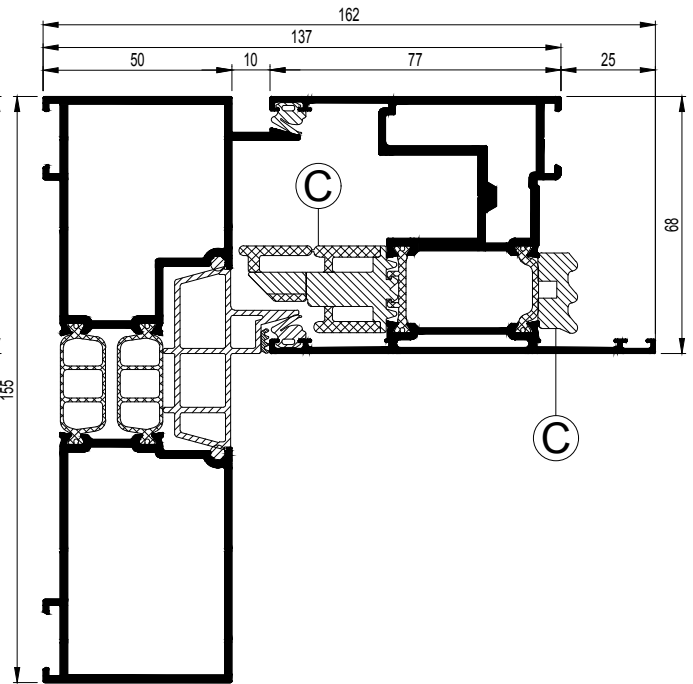
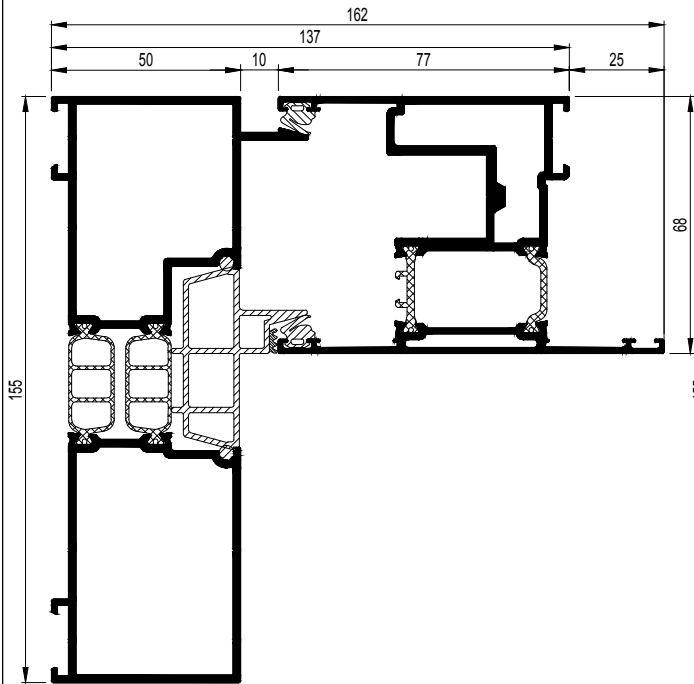

CP155-000013.dwg

CP155-000014.dwg

OPTIE A / OPTION A OPTIE A GETEKEND IN CATALOGUS
 OPTION A DESSINE DANS LE CATALOGUE
 OPTION A DRAWN IN CATALOGUE
 OPTION A GEZEICHENET IM KATALOG

OPTIE C => HI / OPTION C => HI

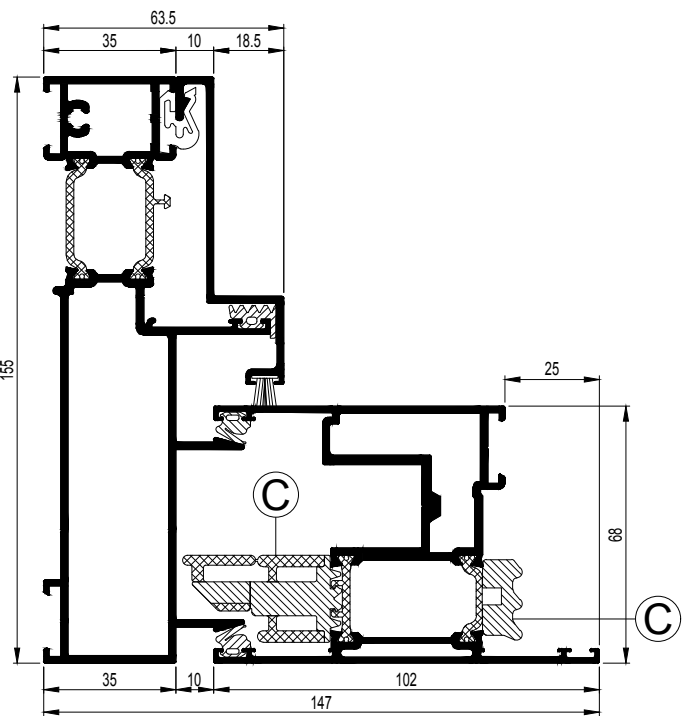
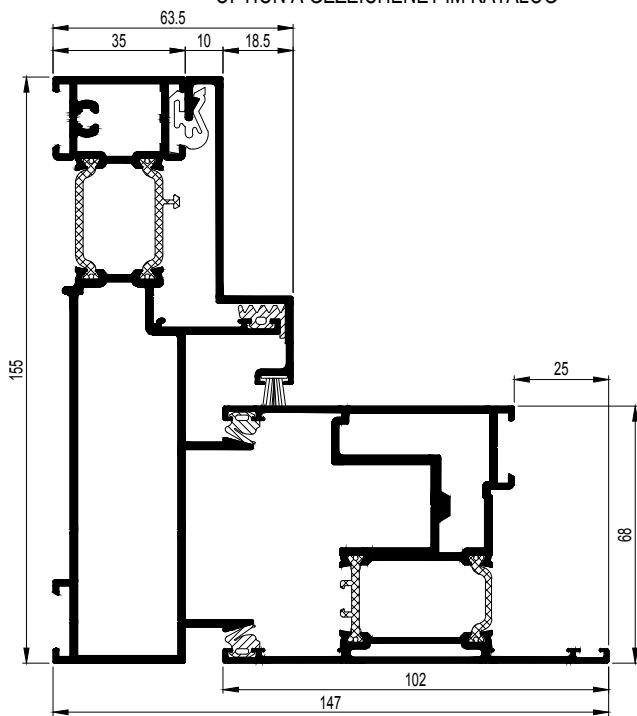

CP155-000015.dwg

CP155-000016.dwg

D0008281

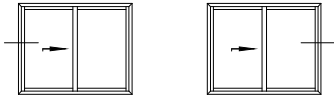

OPTIE A / OPTION A OPTIE A GETEKEND IN CATALOGUS
 OPTION A DESSINE DANS LE CATALOGUE
 OPTION A DRAWN IN CATALOGUE
 OPTION A GEZEICHENET IM KATALOG

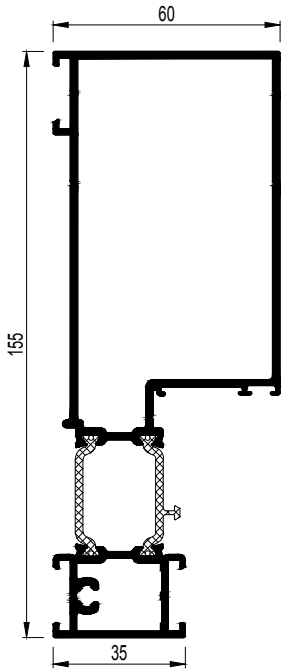

CP155-000017.dwg

OPTIE C => HI / OPTION C => HI

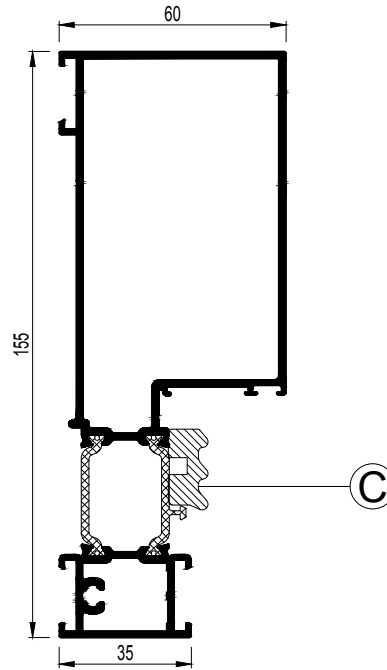

CP155-000018.dwg

OPTIE A / OPTION A OPTIE A GETEKEND IN CATALOGUS
 OPTION A DESSINE DANS LE CATALOGUE
 OPTION A DRAWN IN CATALOGUE
 OPTION A GEZEICHENET IM KATALOG

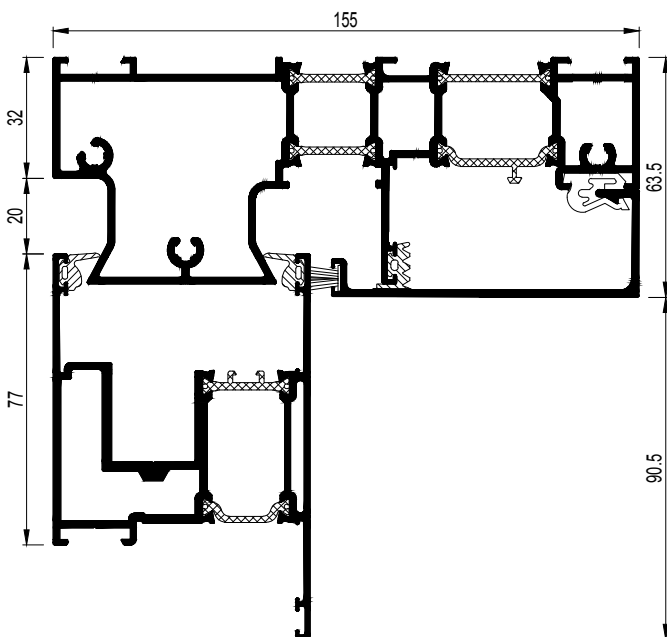

CP155-000019.dwg

OPTIE C => HI / OPTION C => HI

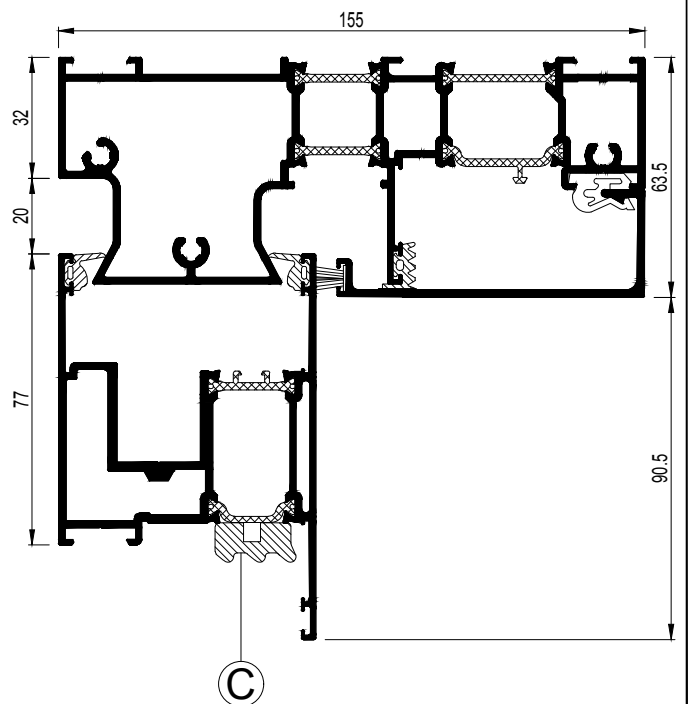

CP155-000020.dwg

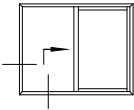

OPTIE A / OPTION A OPTIE A GETEKEND IN CATALOGUS
OPTION A DESSINE DANS LE CATALOGUE
OPTION A DRAWN IN CATALOGUE
OPTION A GEZEICHENET IM KATALOG

OPTIE C => HI / OPTION C => HI

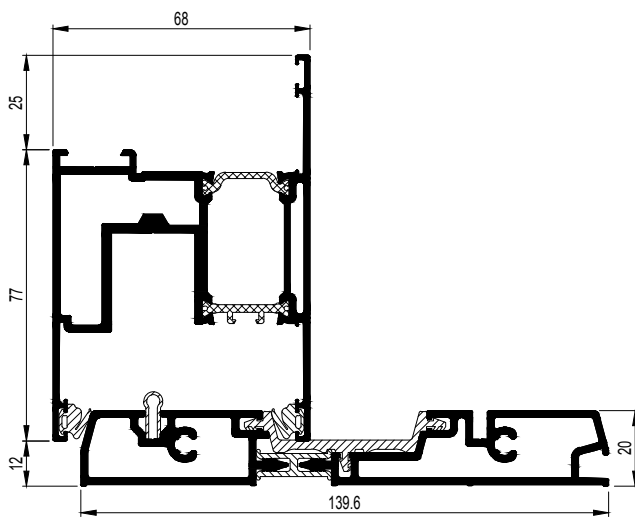

CP155-000021.dwg

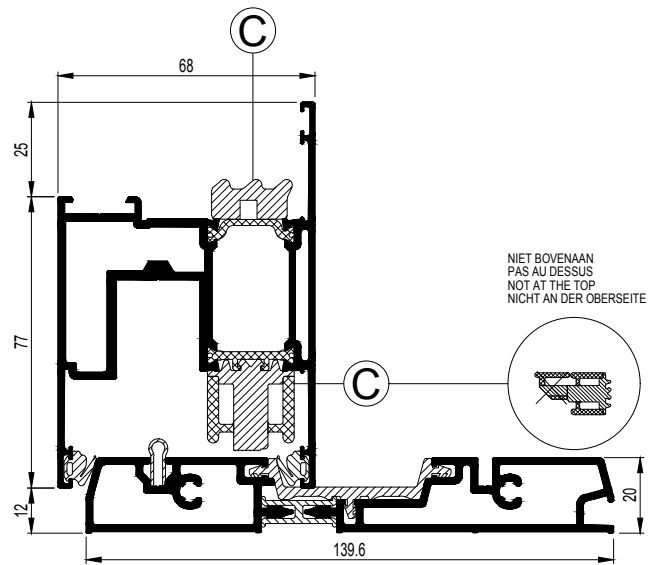

CP155-000022.dwg

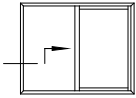

MINERGIE

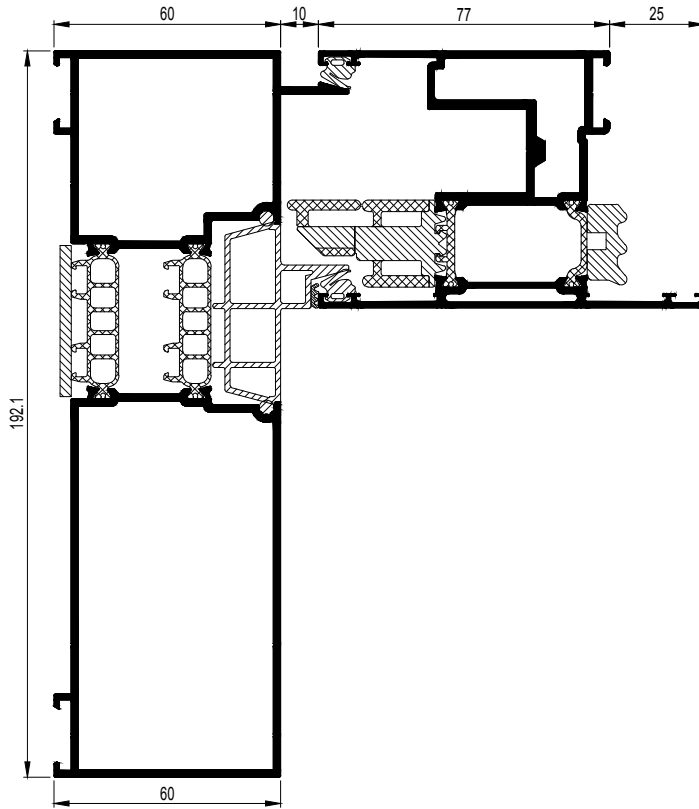

CP155-000023.dwg

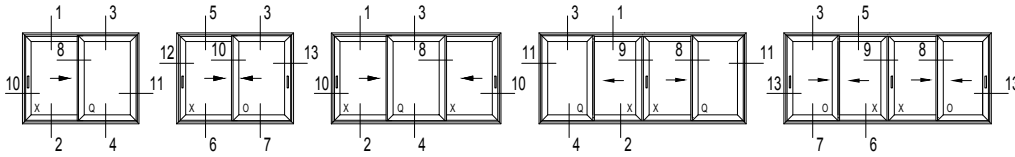

1

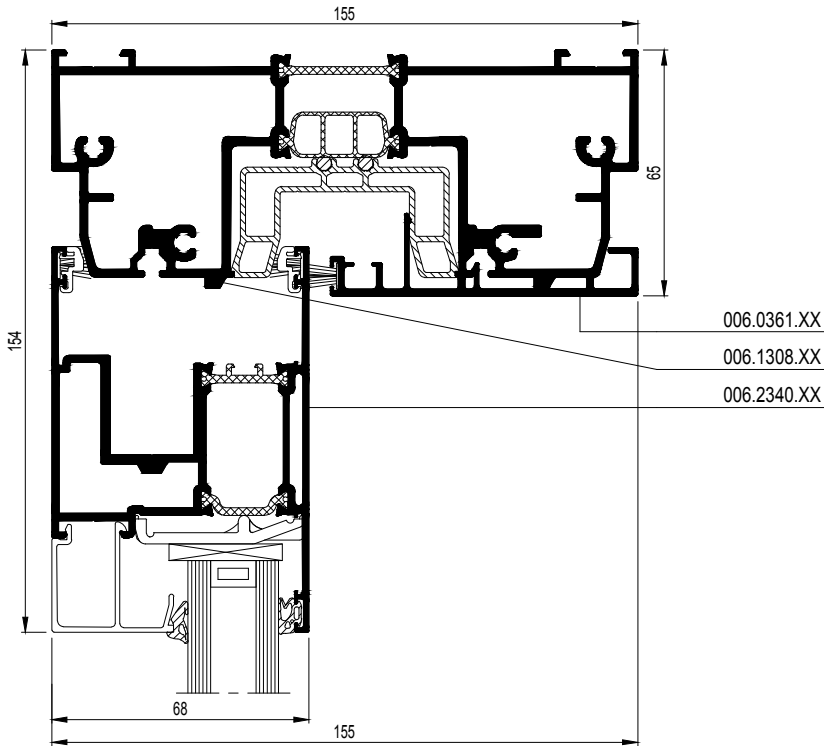

CP155-001001.dwg

2

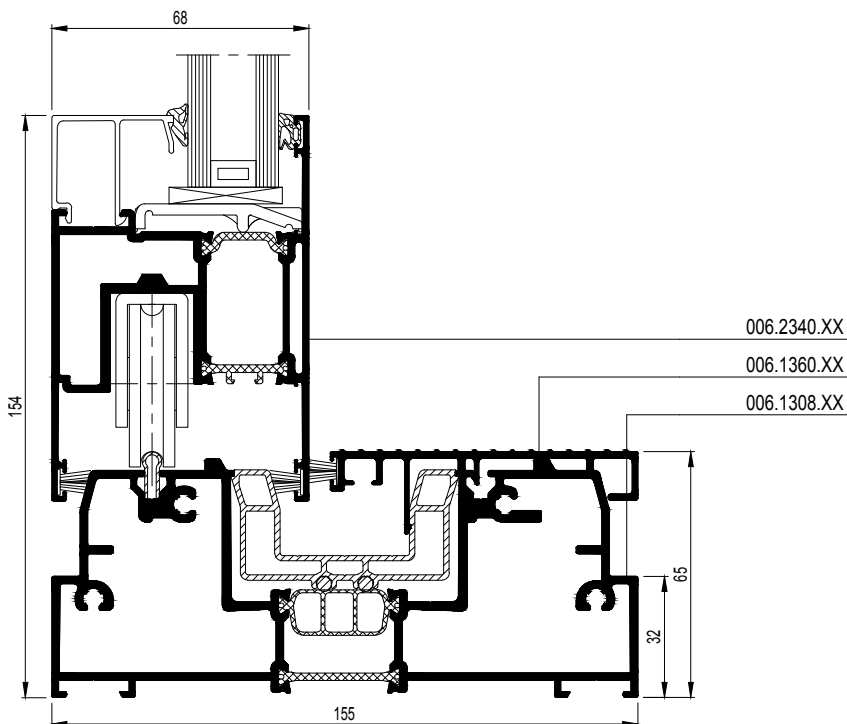

CP155-002001.dwg

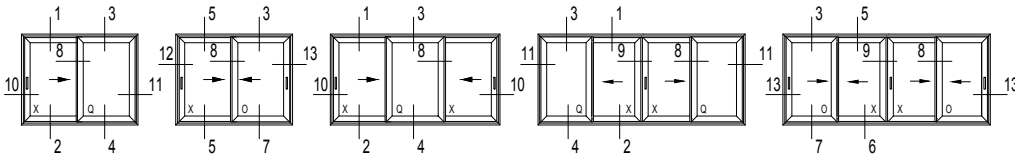

3

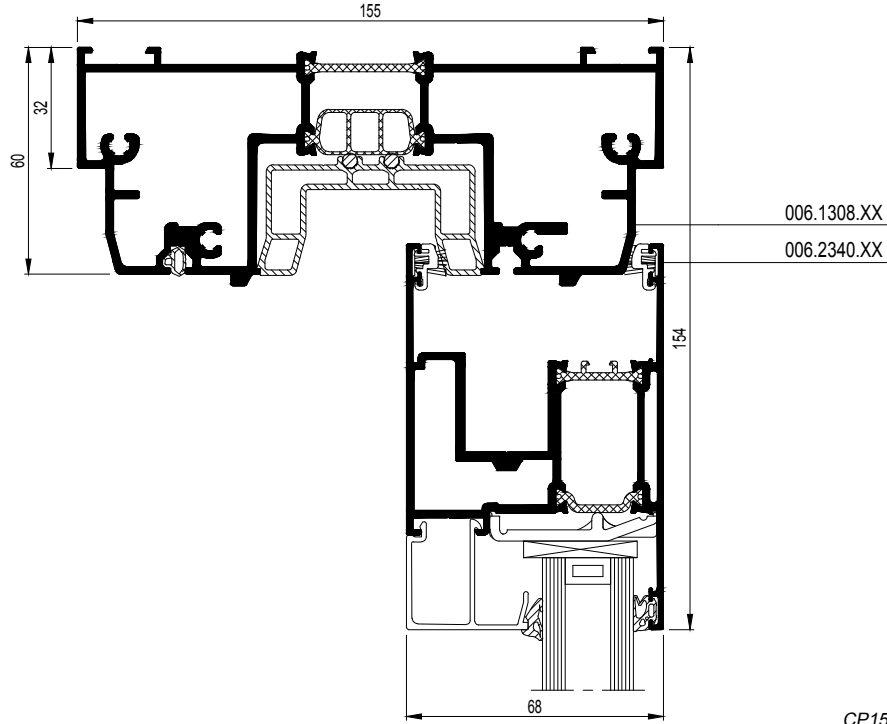

CP155-003001.dwg

4

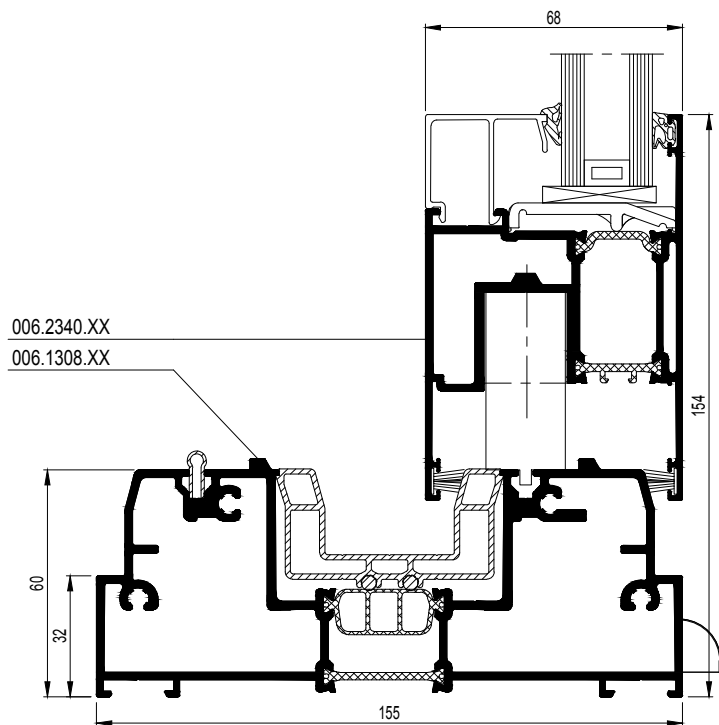

CP155-004001.dwg

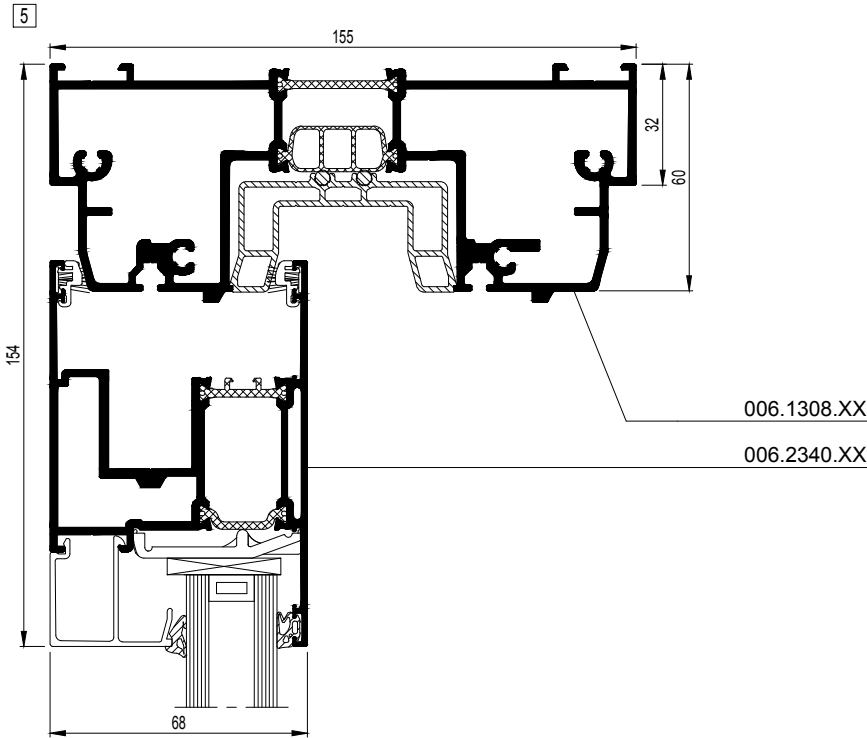
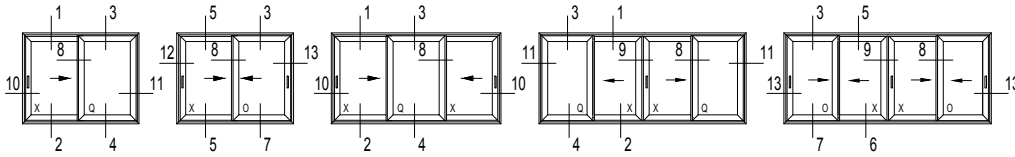

CP155-005001.dwg

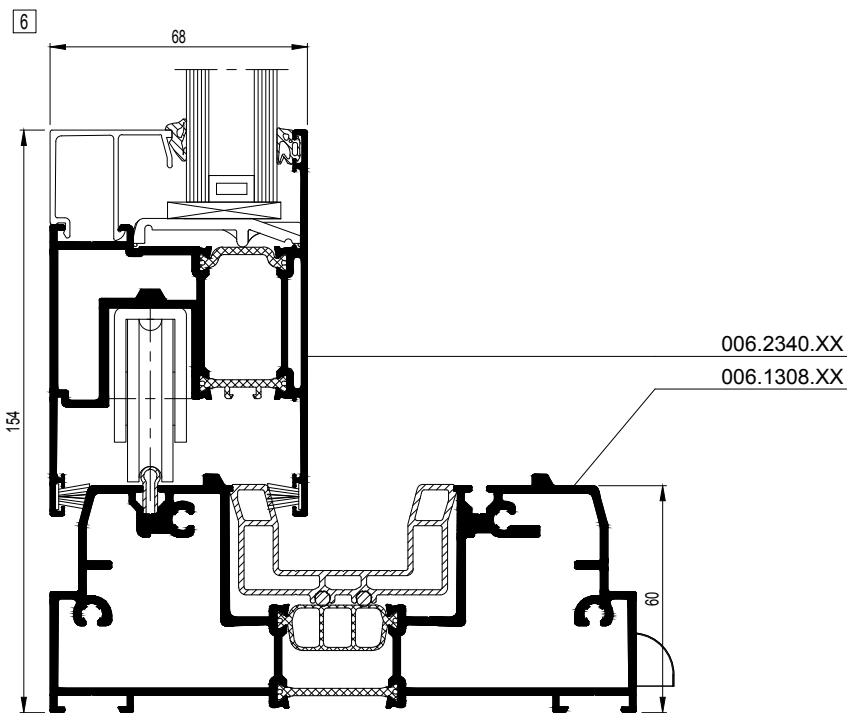

CP155-006001.dwg

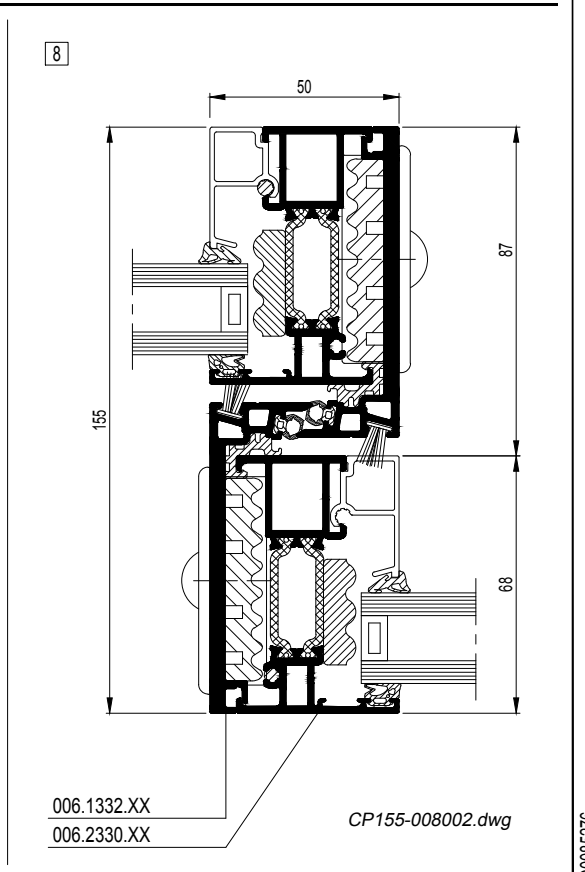
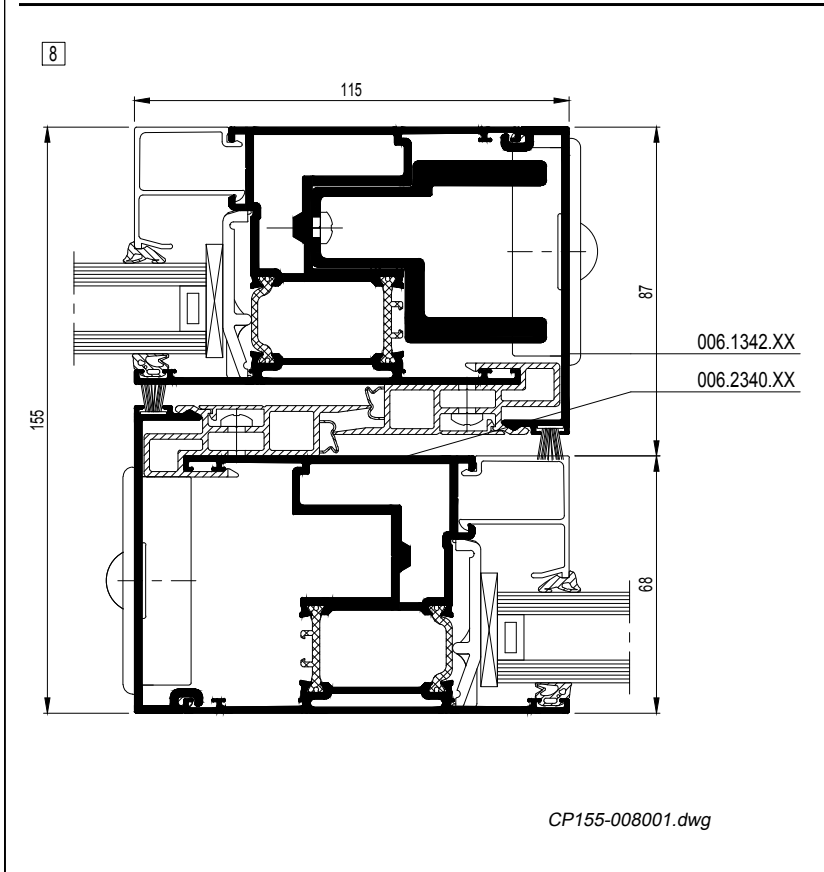
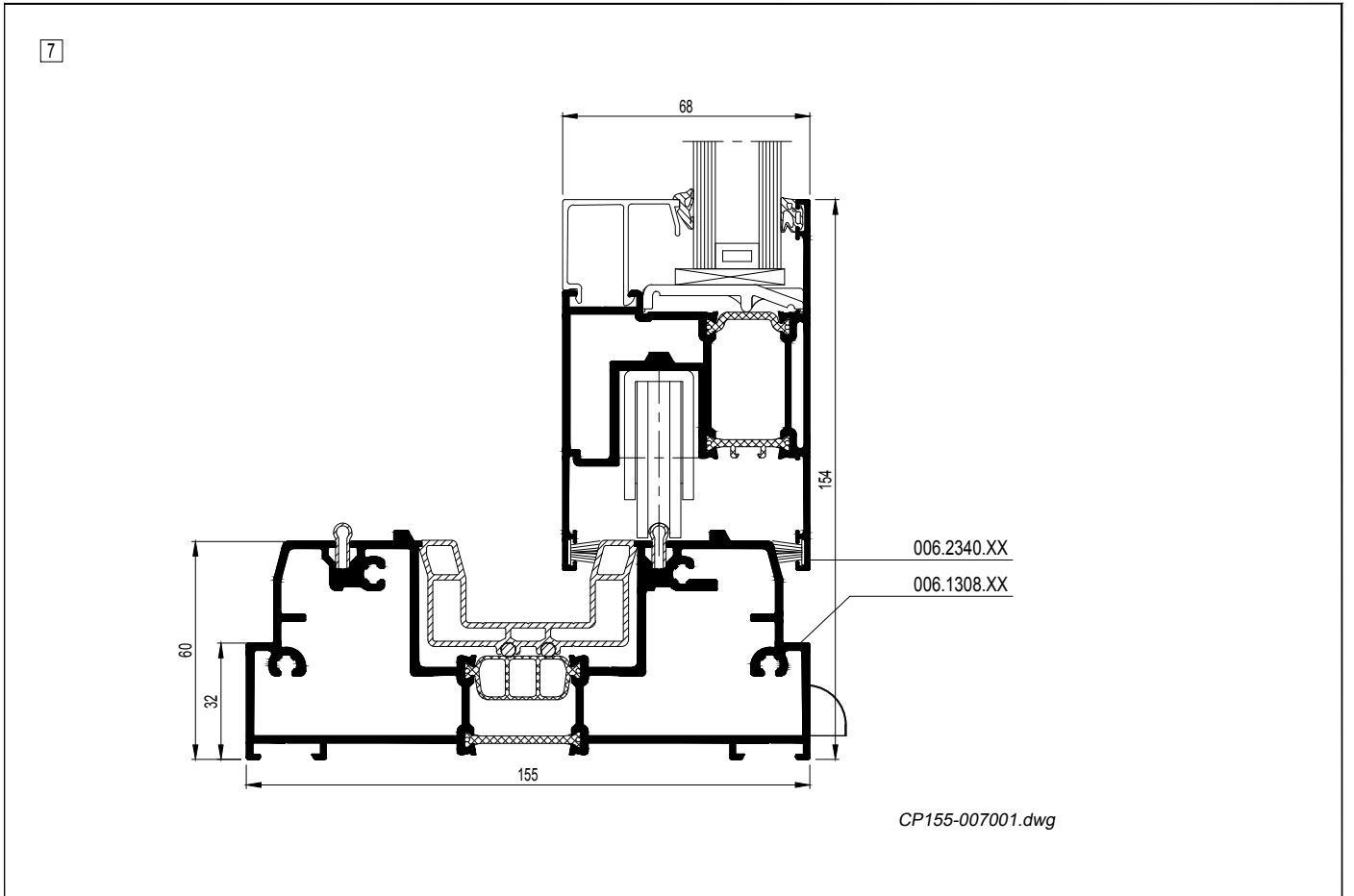
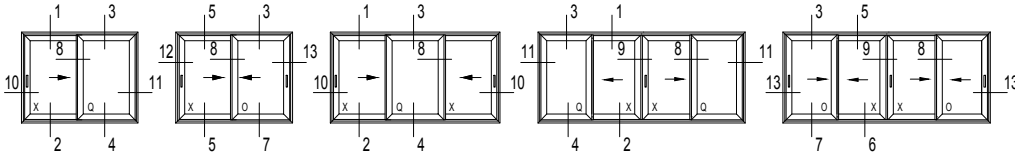

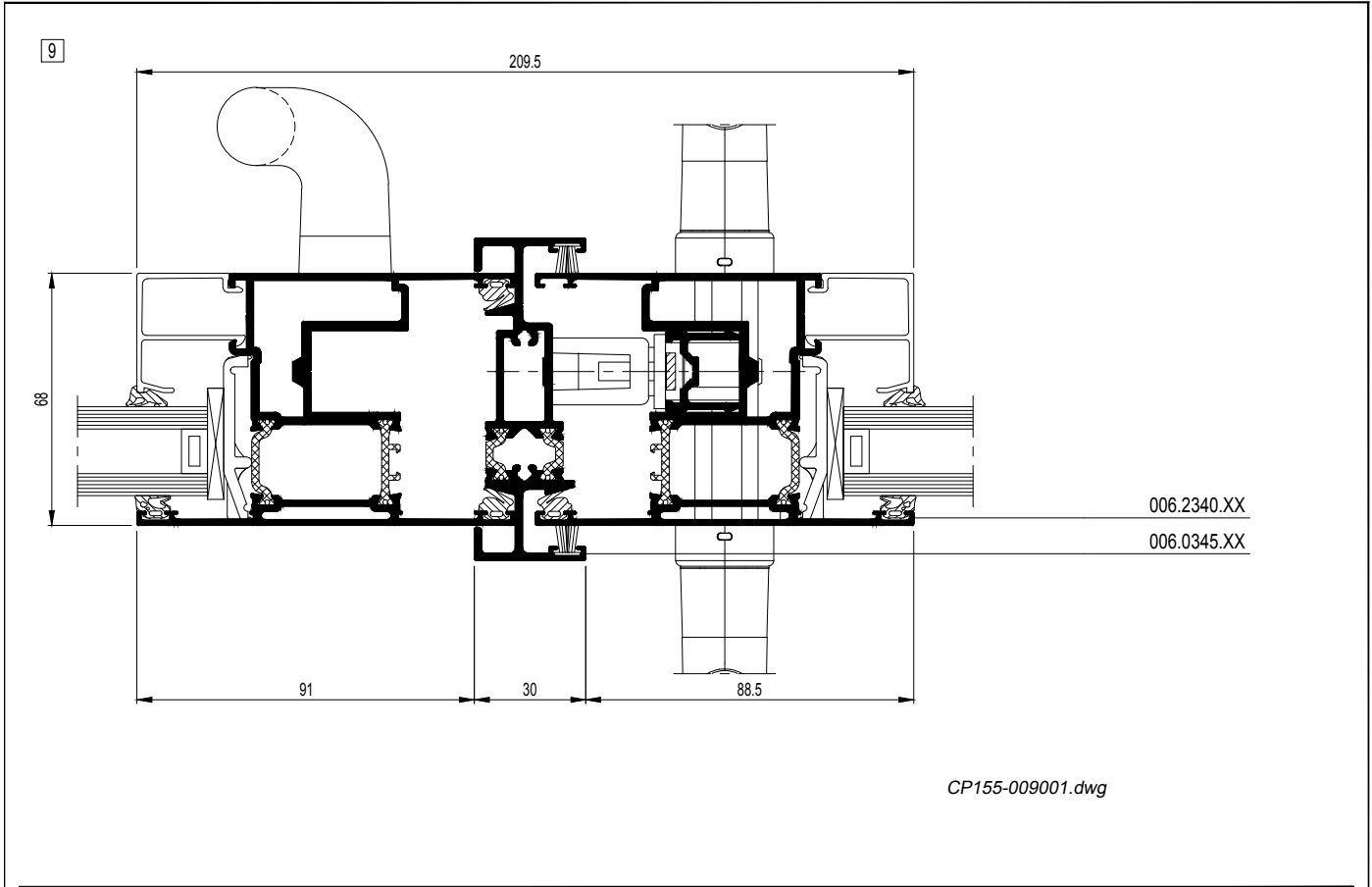
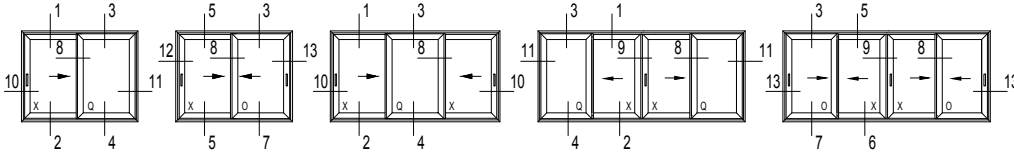

CP155-009001.dwg

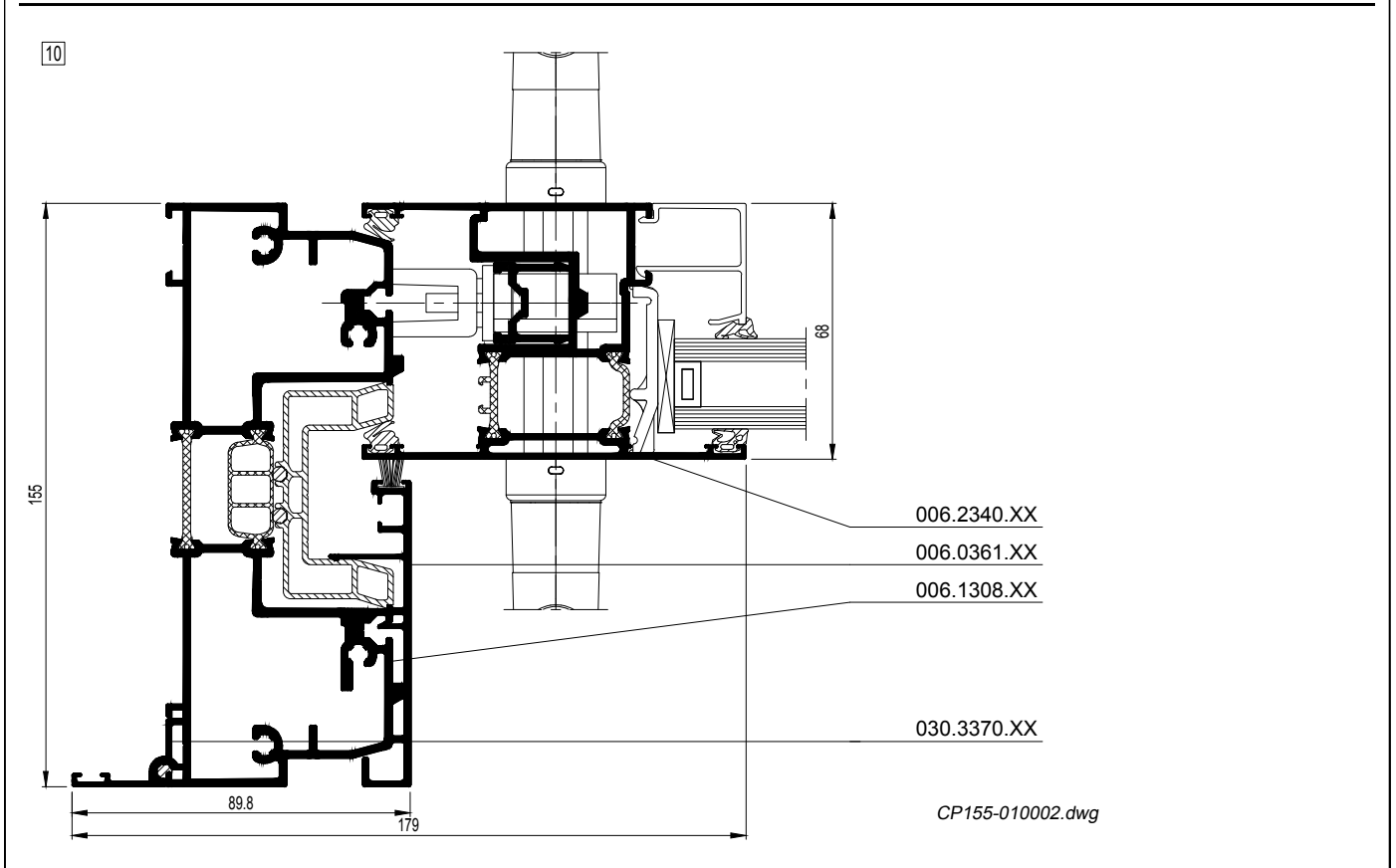
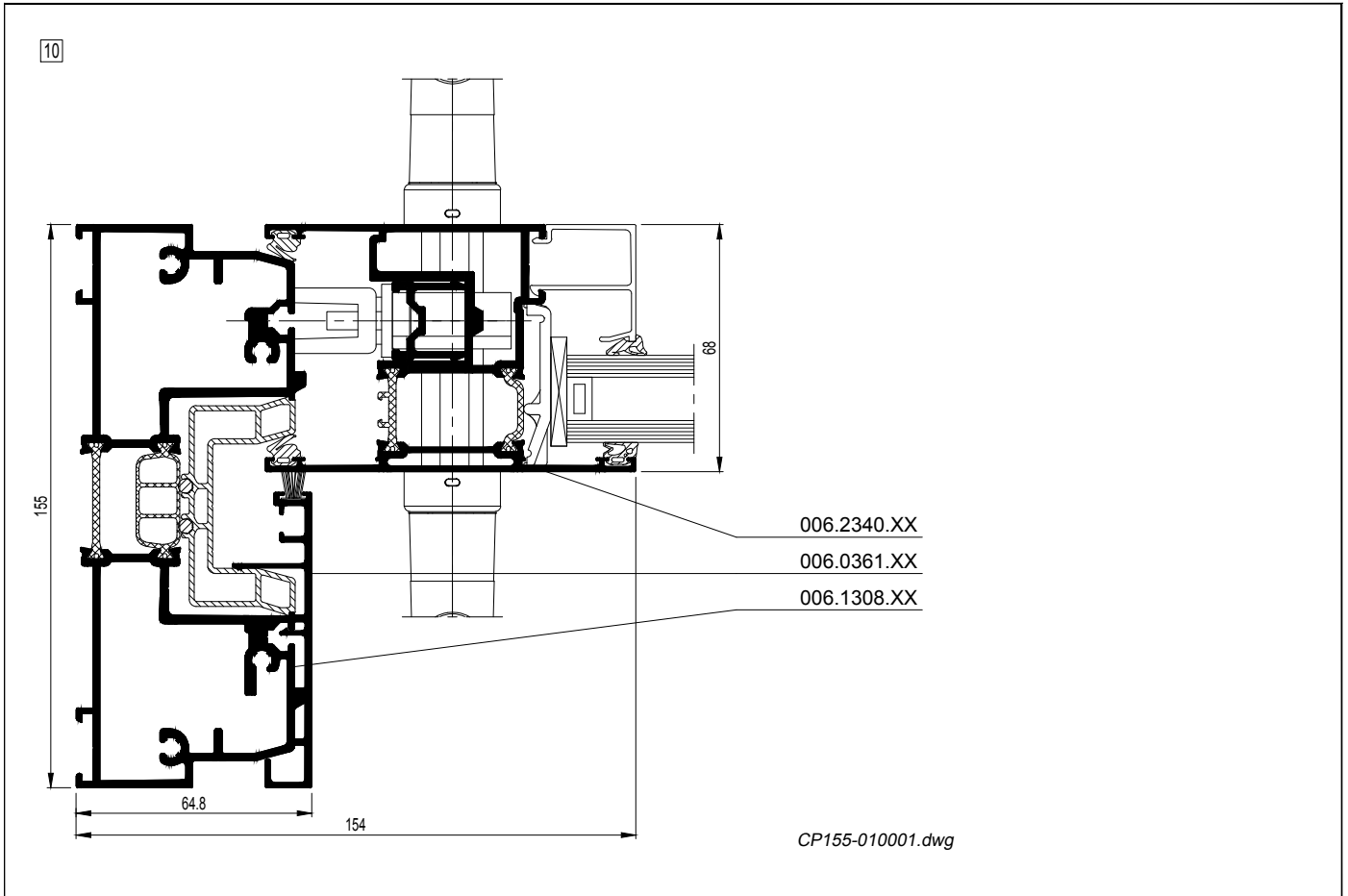
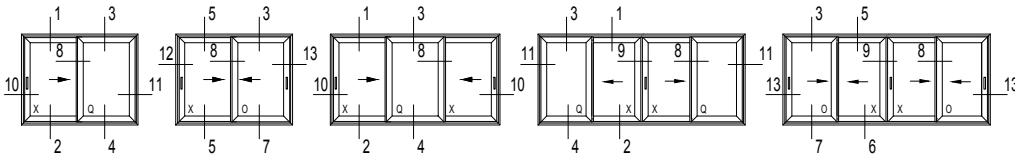

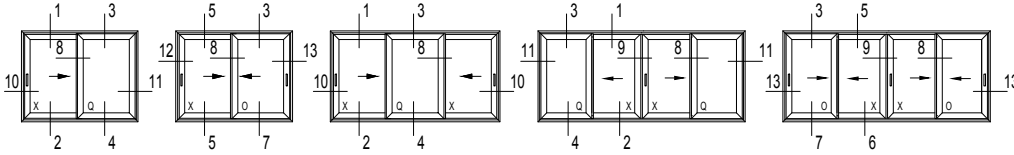

11

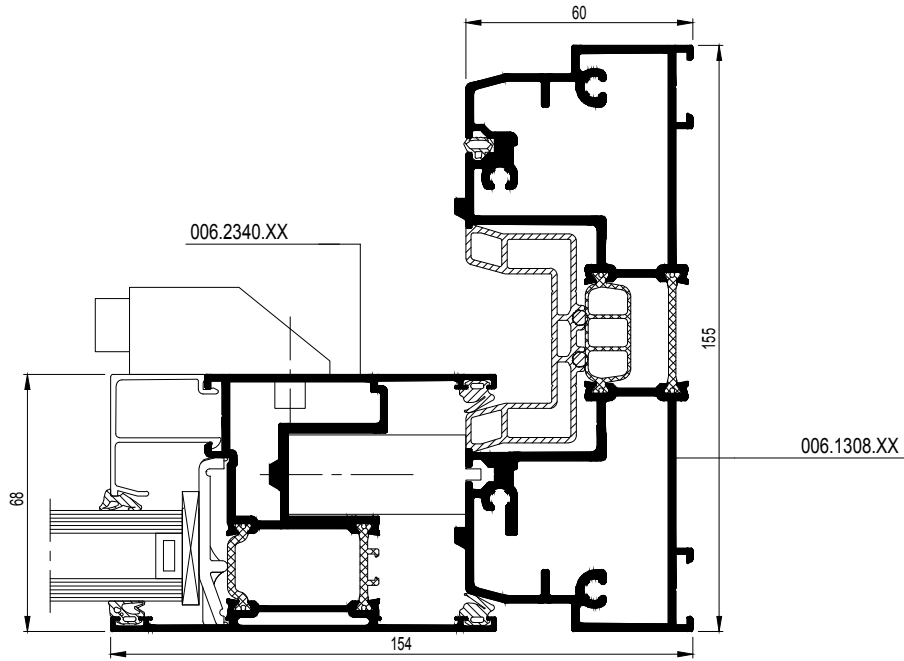

CP155-011001.dwg

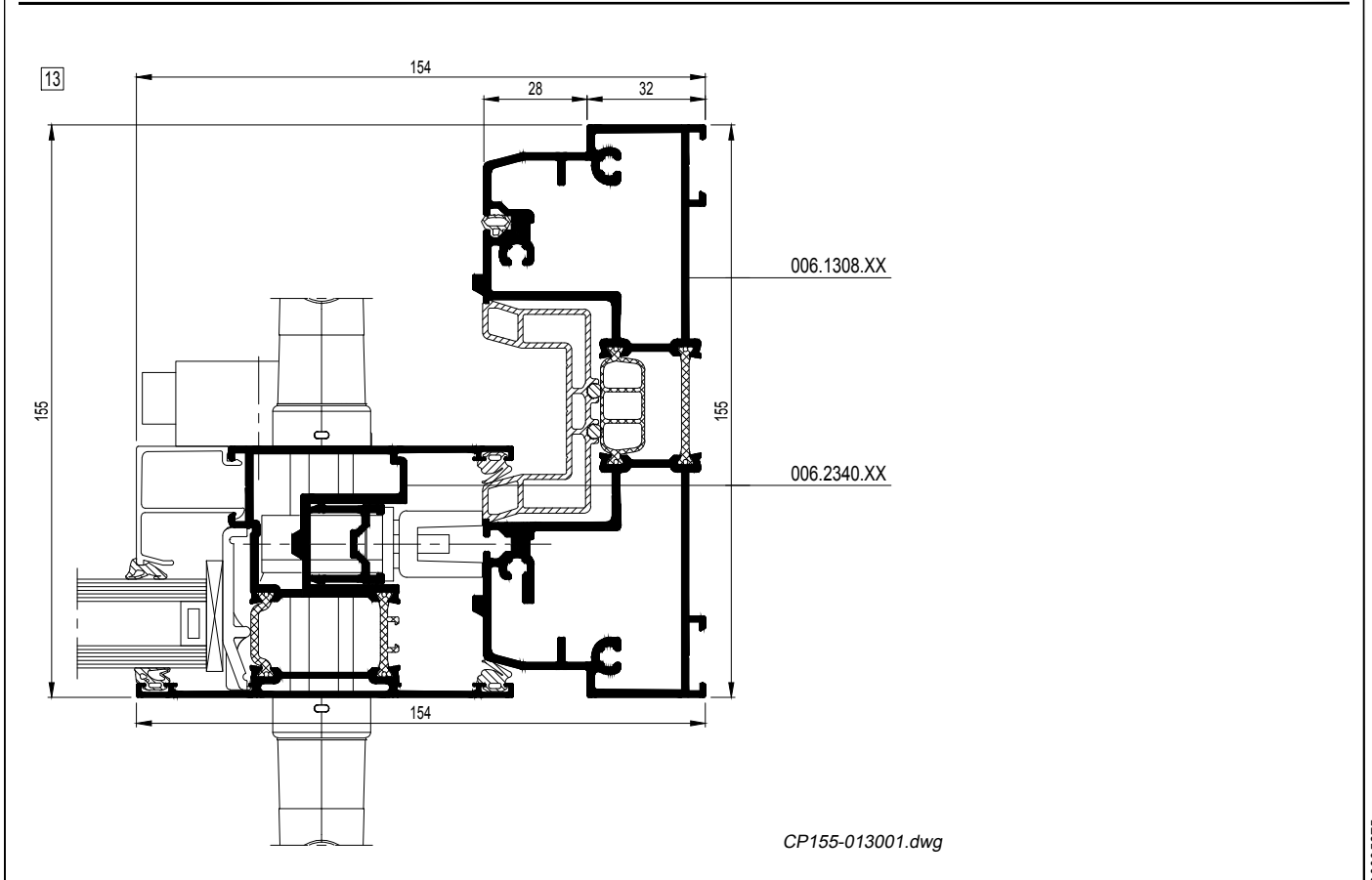
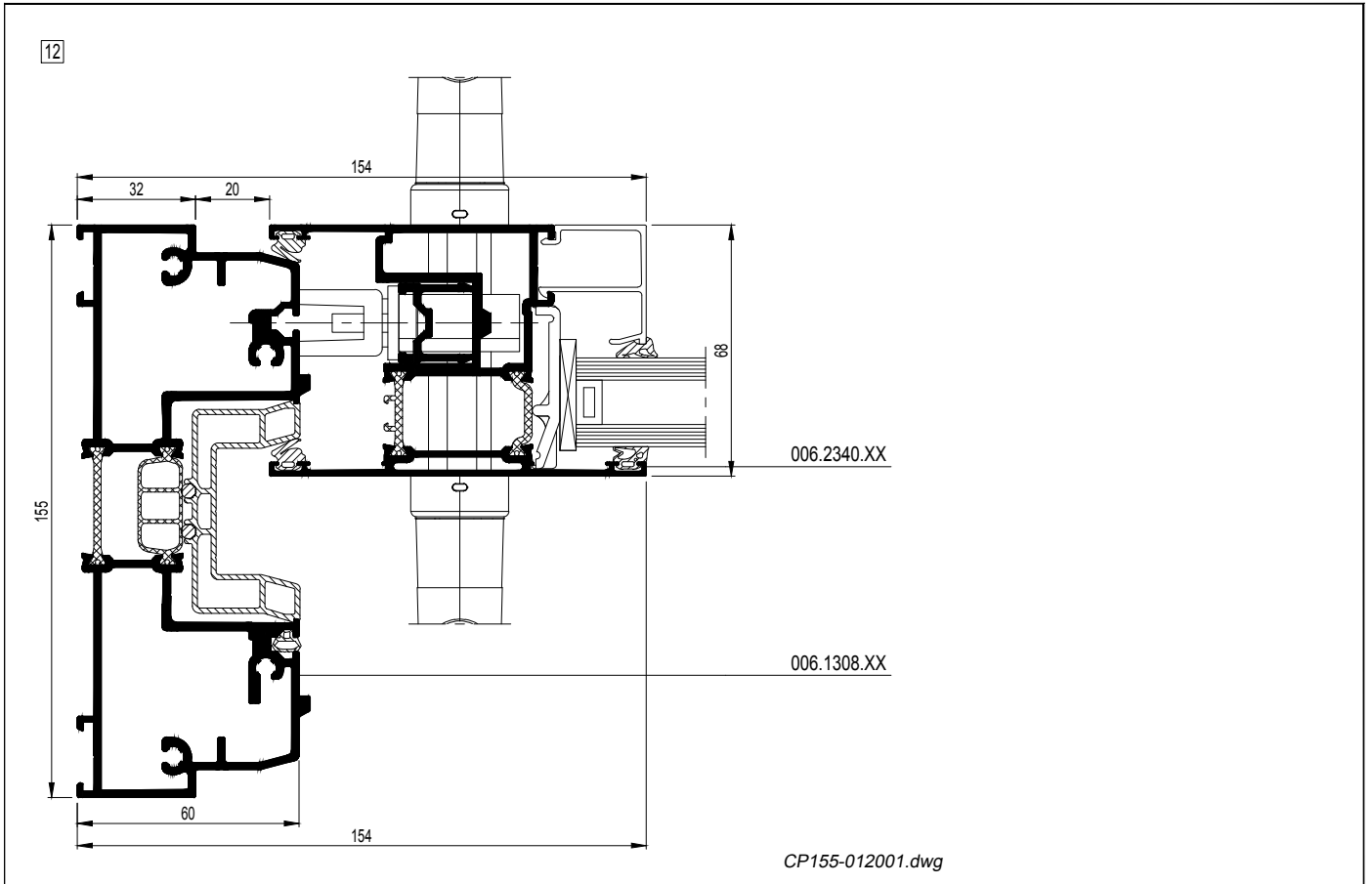
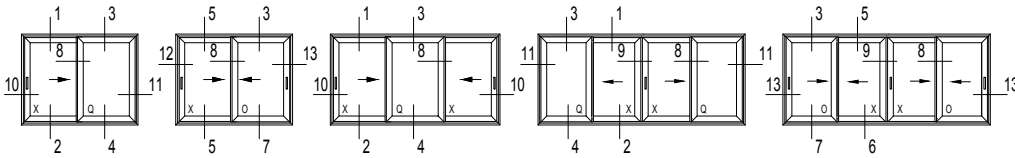

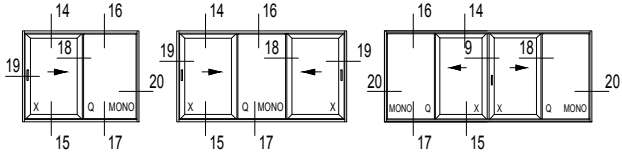

14

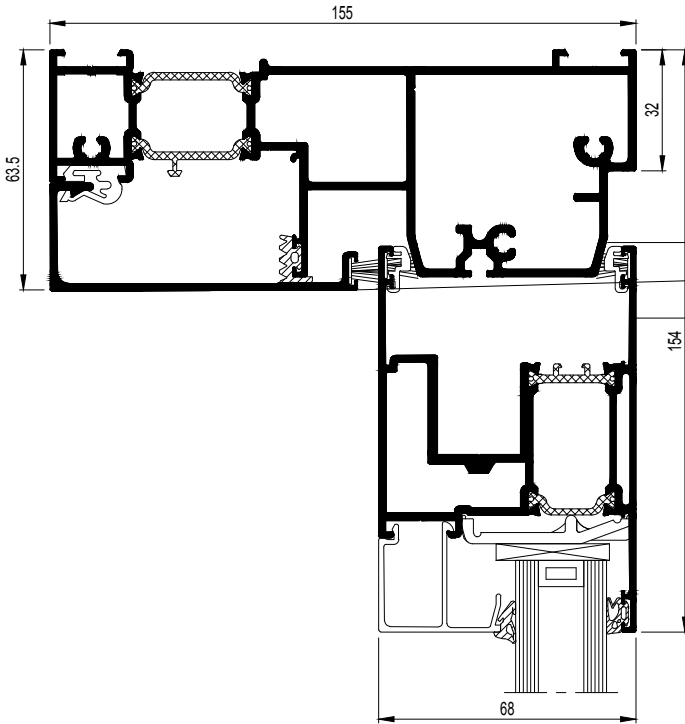

006.0320.XX

006.0330.XX

006.2340.XX

CP155-014001.dwg

15

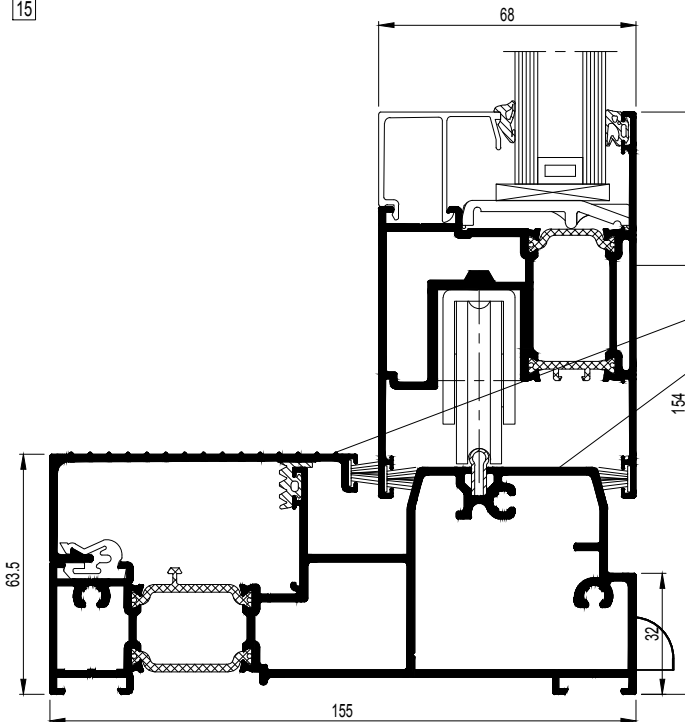

006.2340.XX

006.0362.XX

006.0320.XX

CP155-015001.dwg

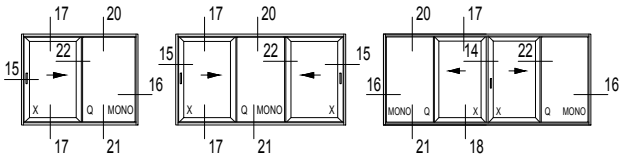

16

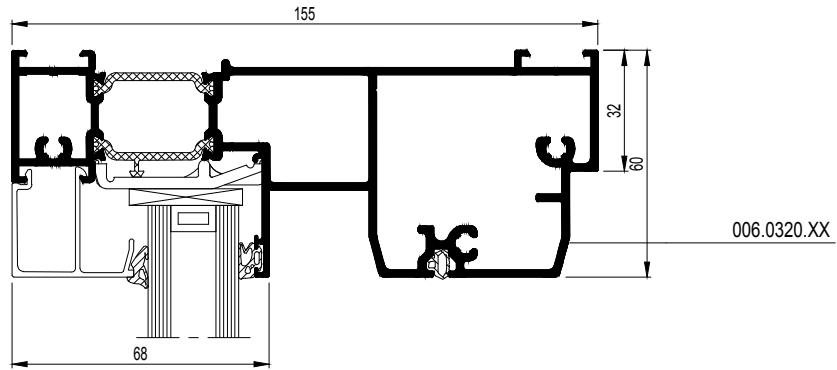

CP155-016001.dwg

17

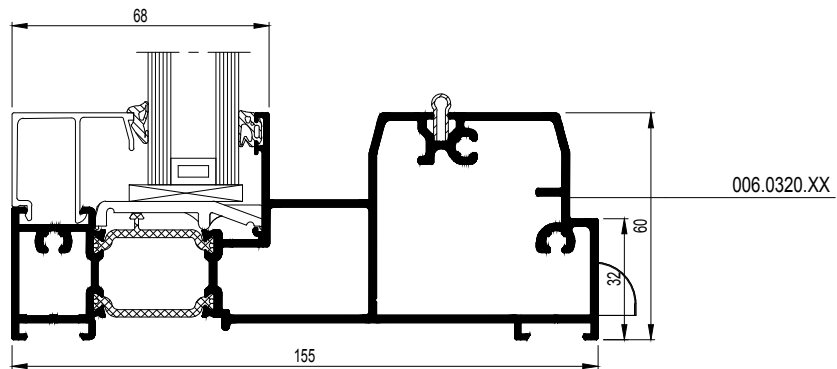

CP155-017001.dwg

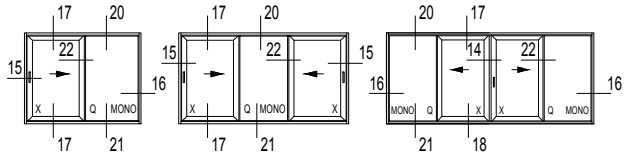

18

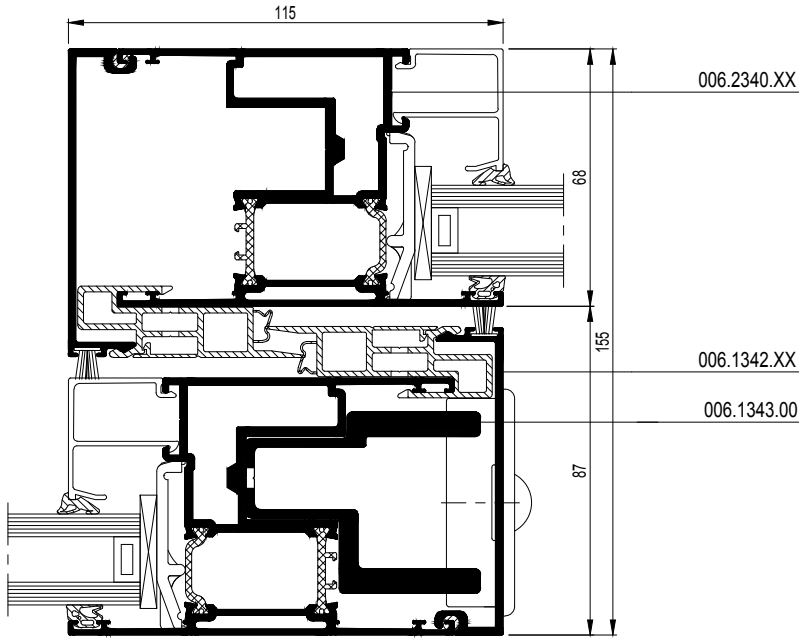

CP155-018001.dwg

18

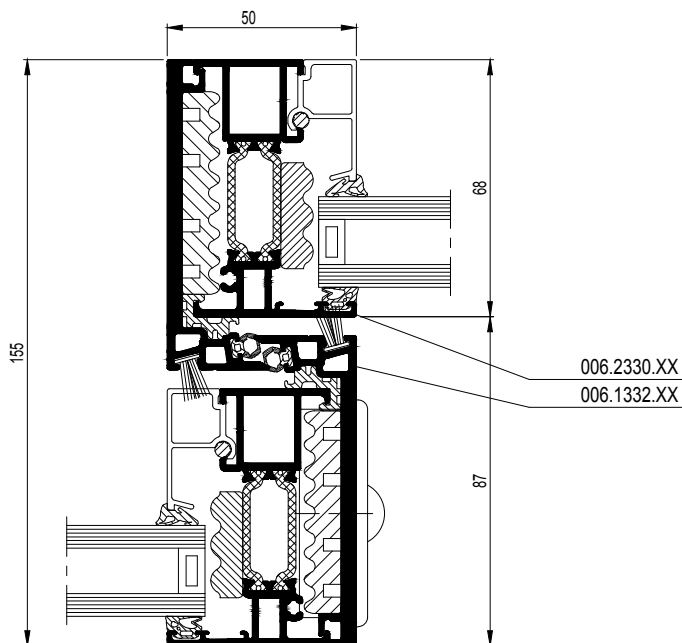

CP155-018002.dwg

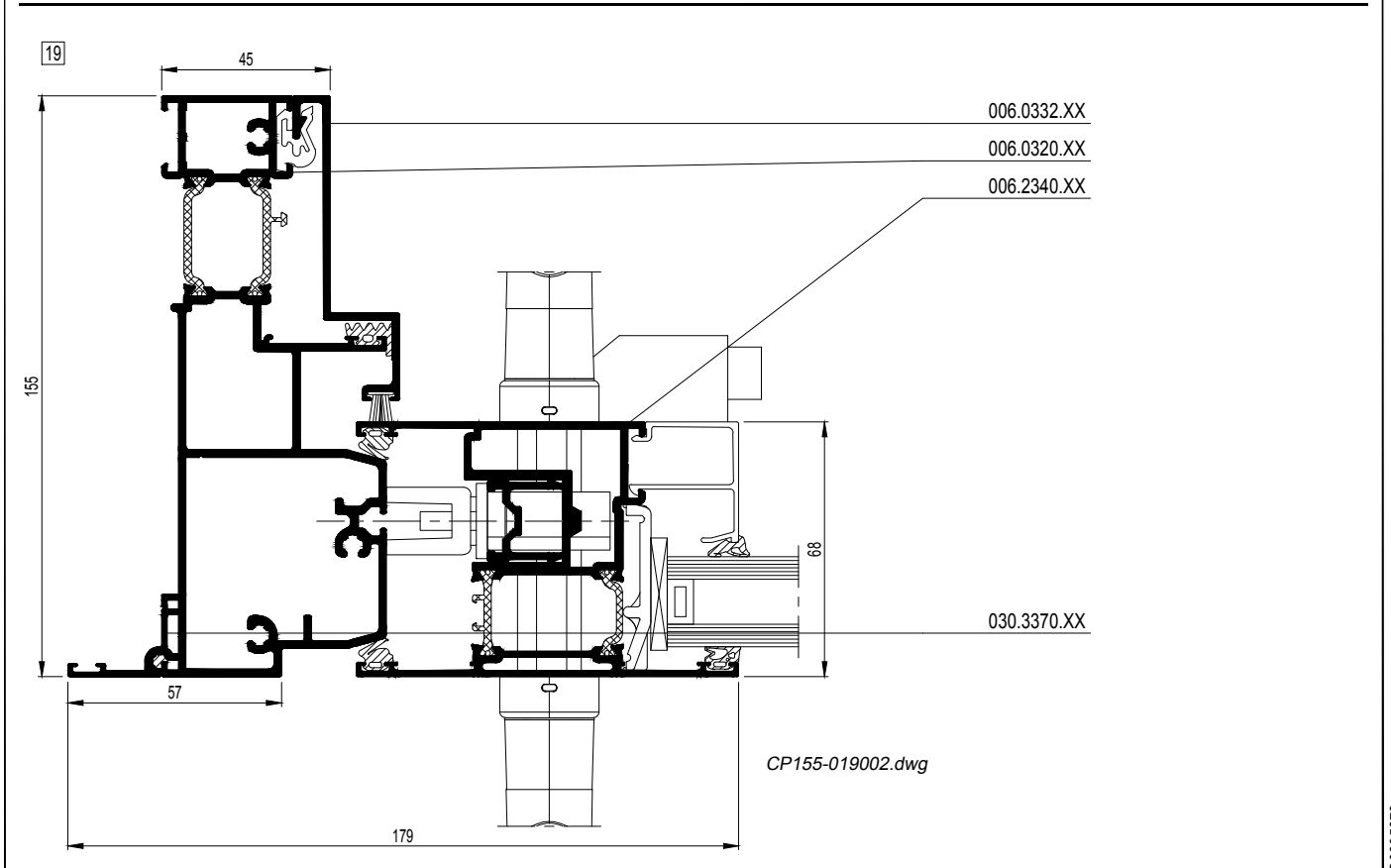
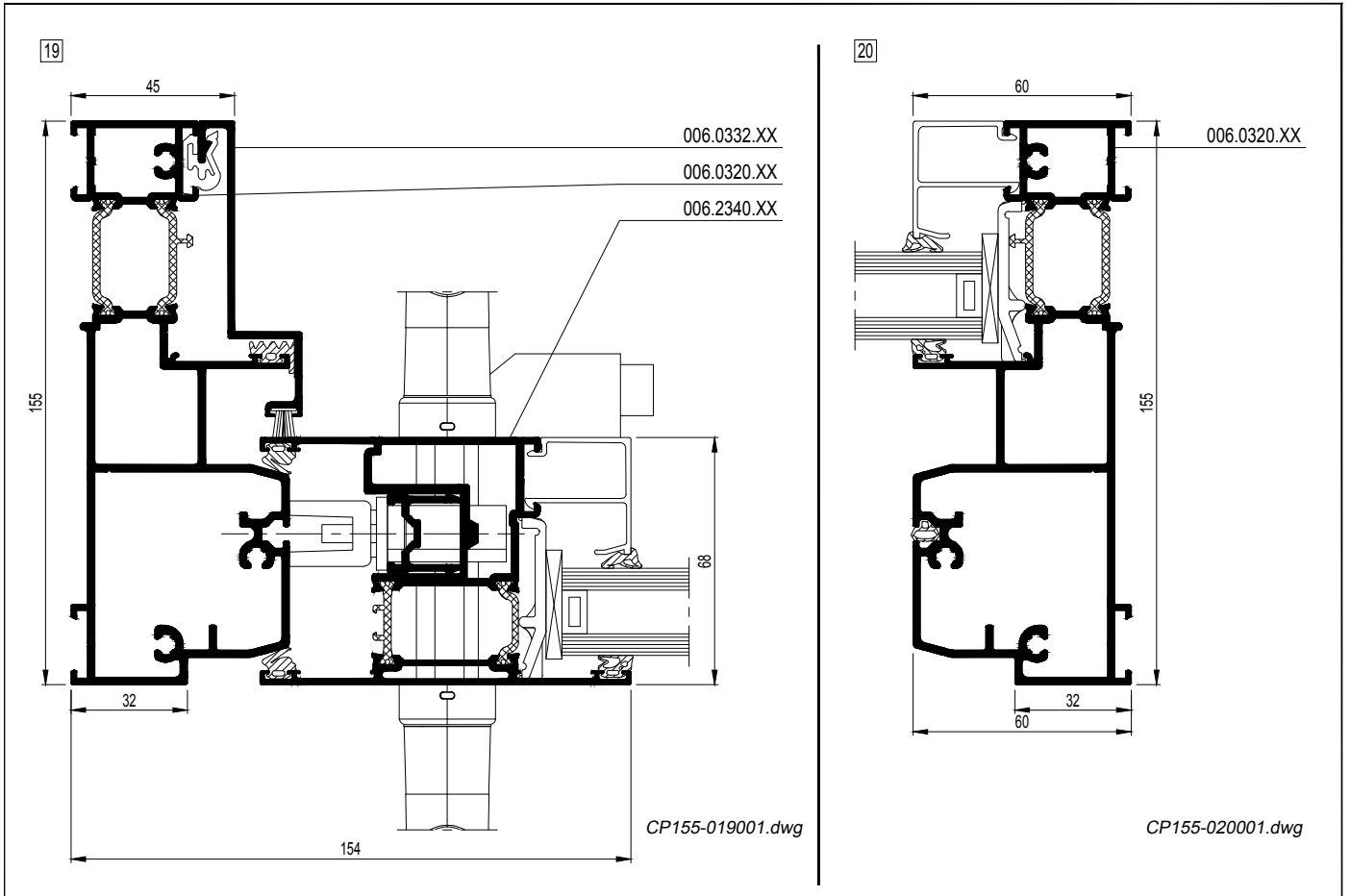
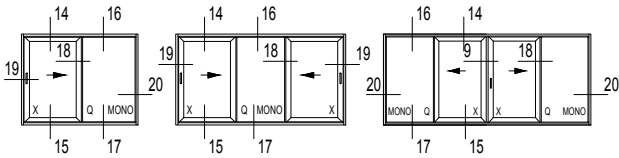

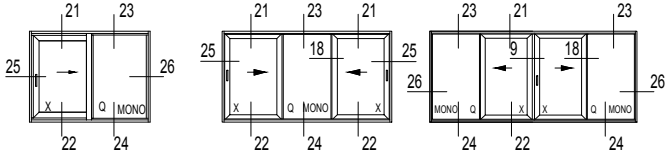

21

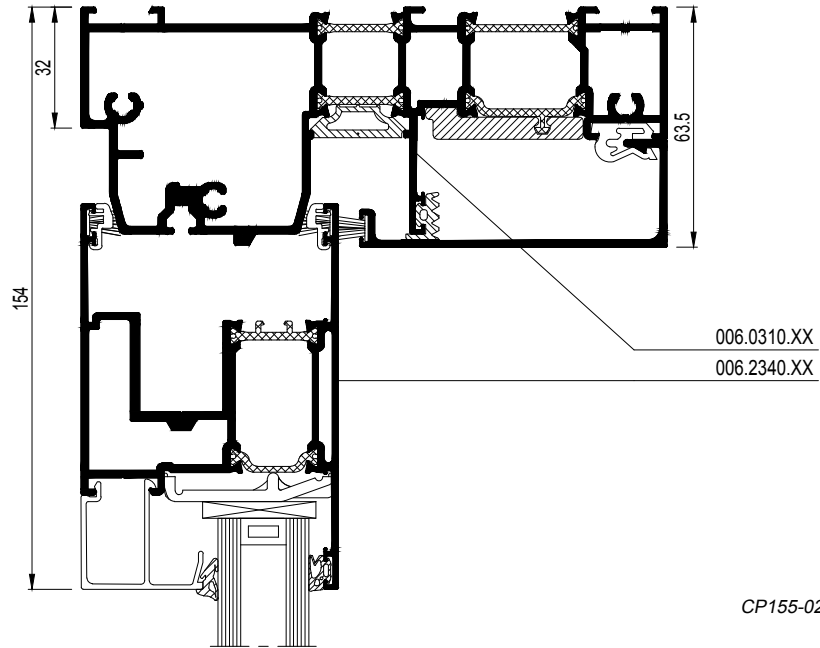

CP155-021001.dwg

22

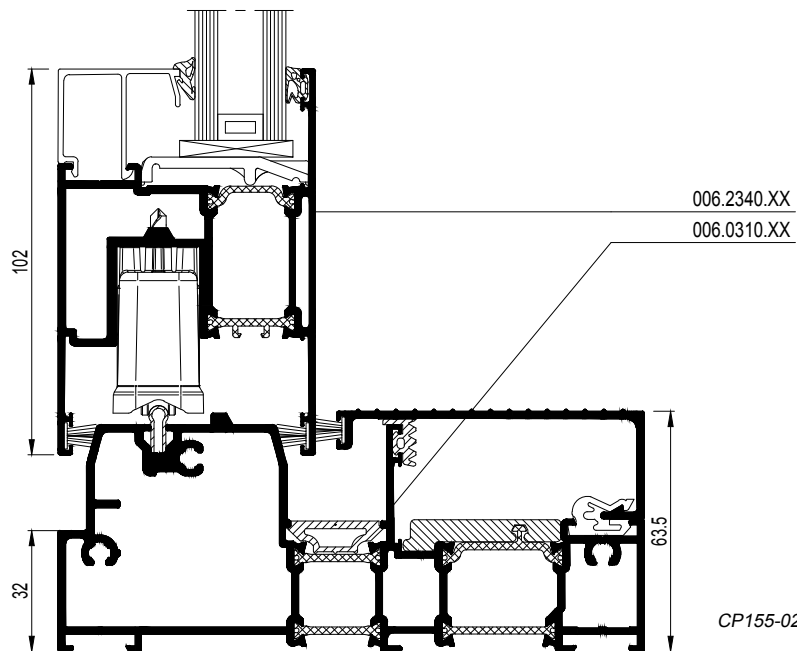

CP155-022001.dwg

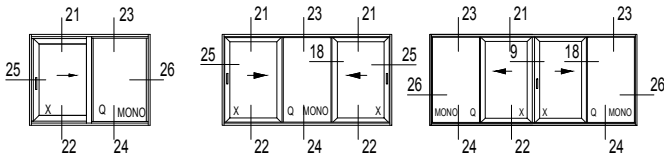

23

006.0310.XX

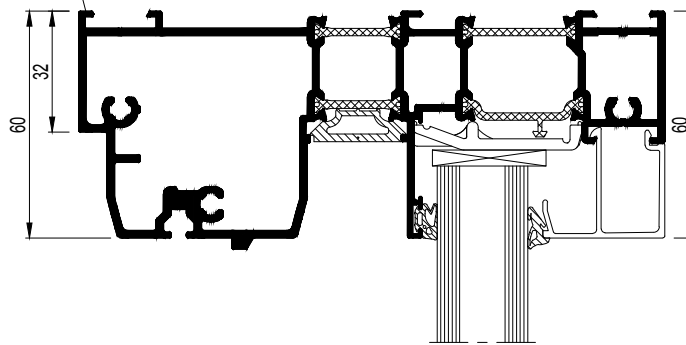

CP155-023001.dwg

24

006.0310.XX

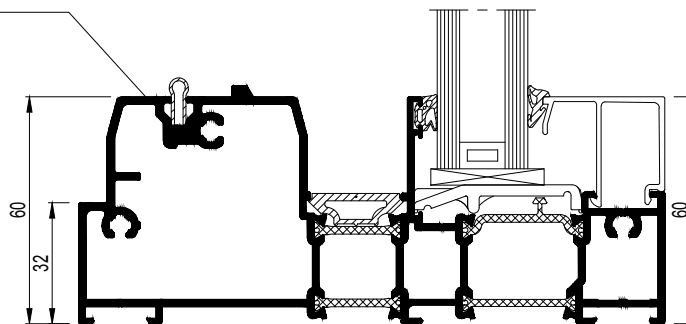

CP155-024001.dwg

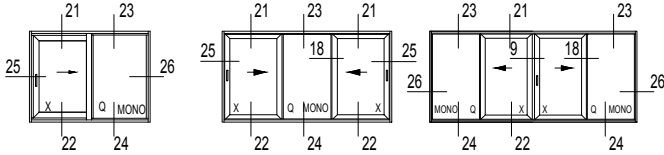

25

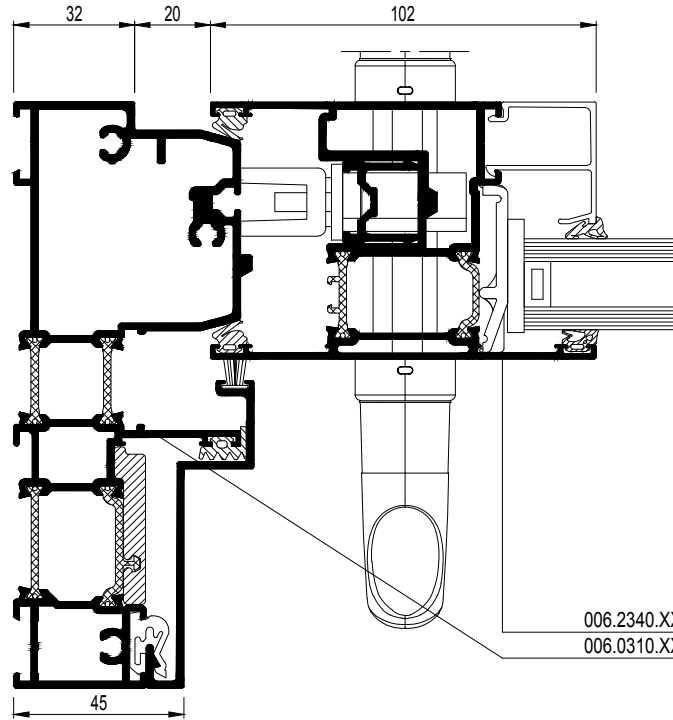

006.2340.XX
 006.0310.XX

CP155-025001.dwg

26

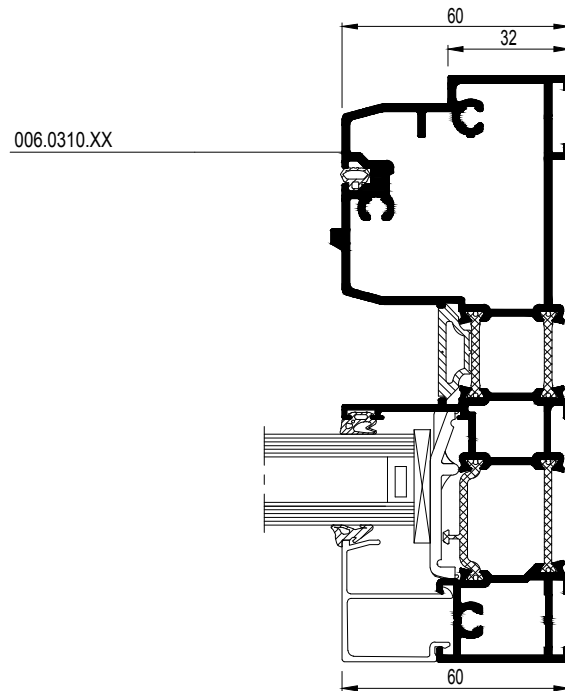

006.0310.XX

CP155-026001.dwg

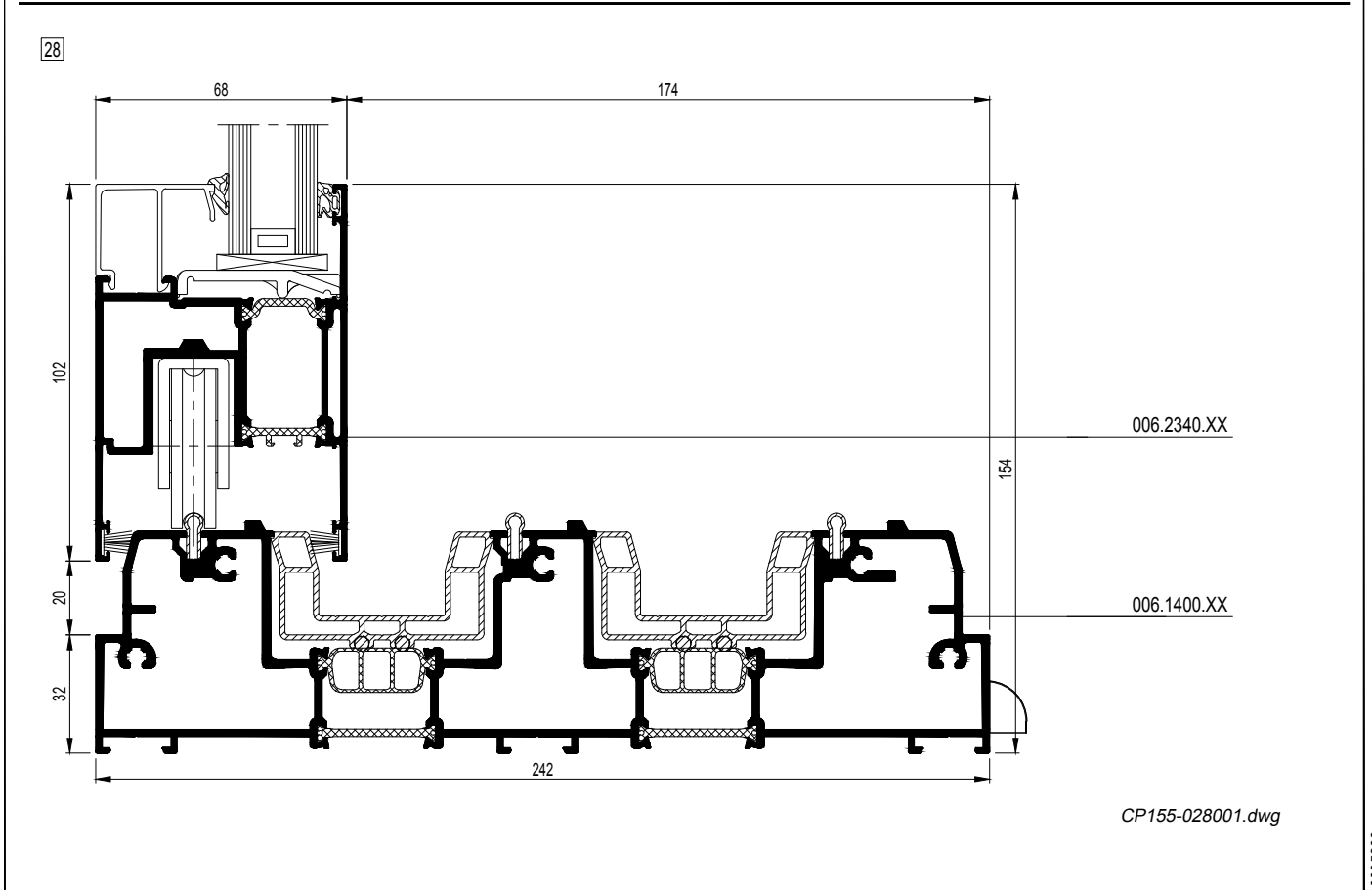
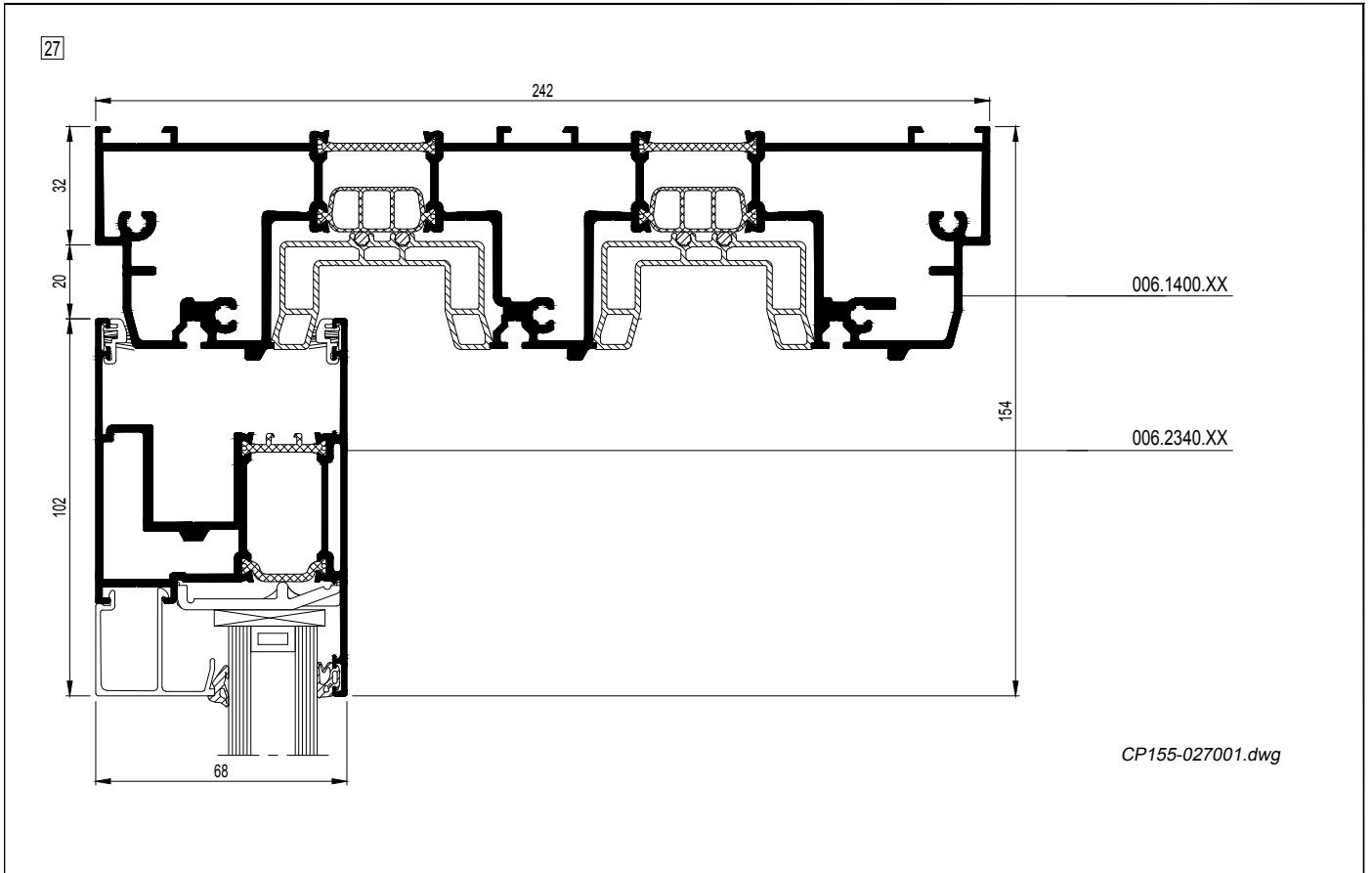
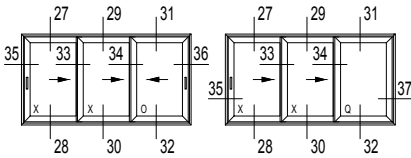

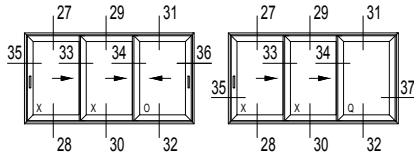

29

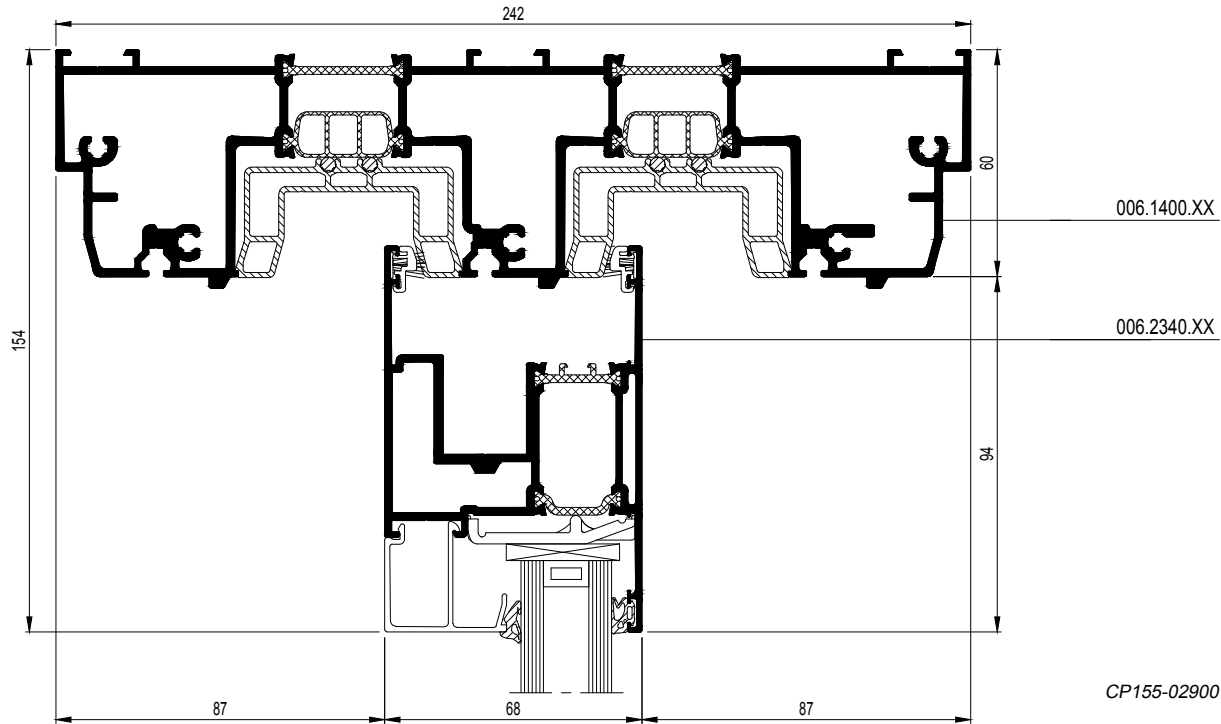

CP155-029001.dwg

30

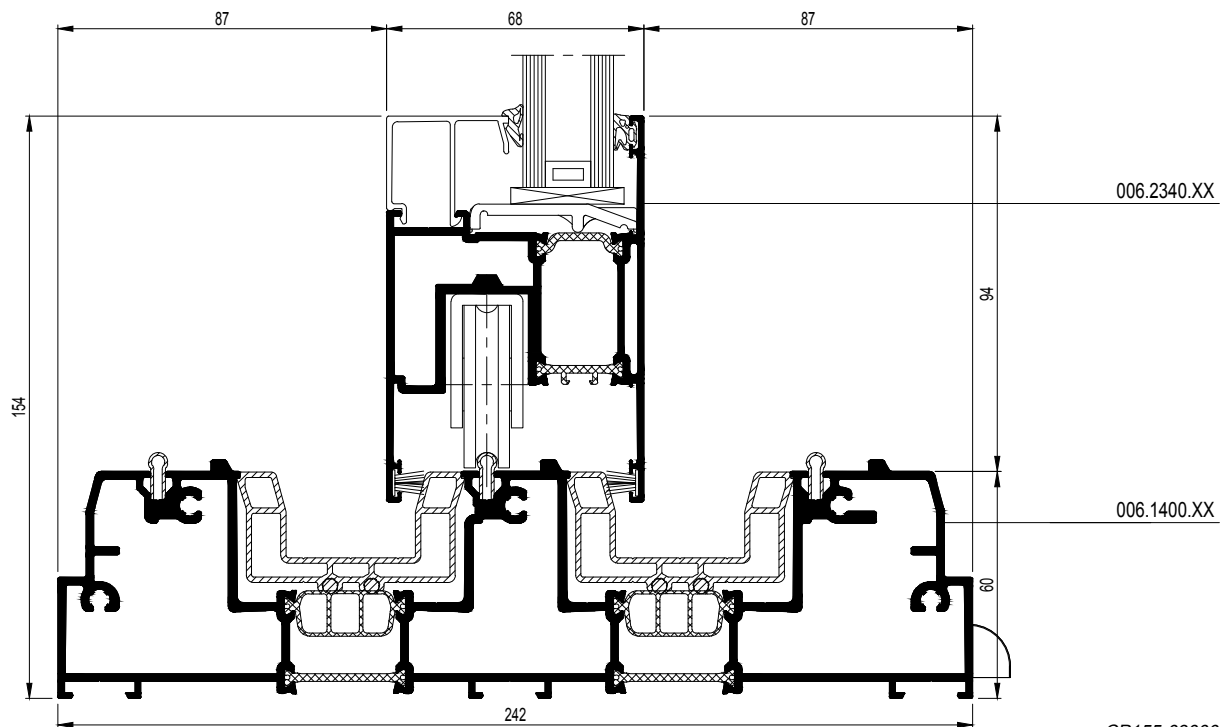

CP155-030001.dwg

D0008289

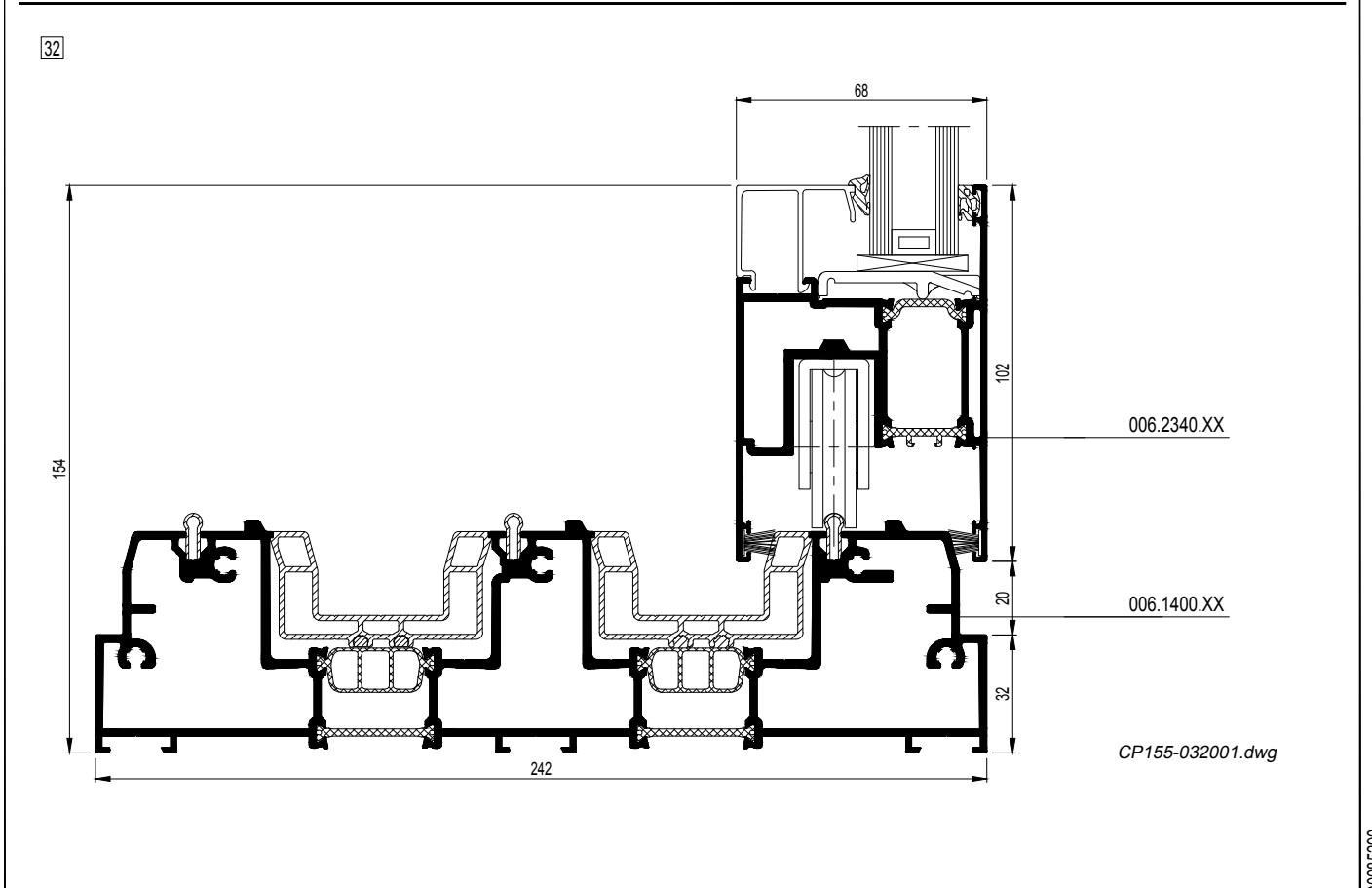
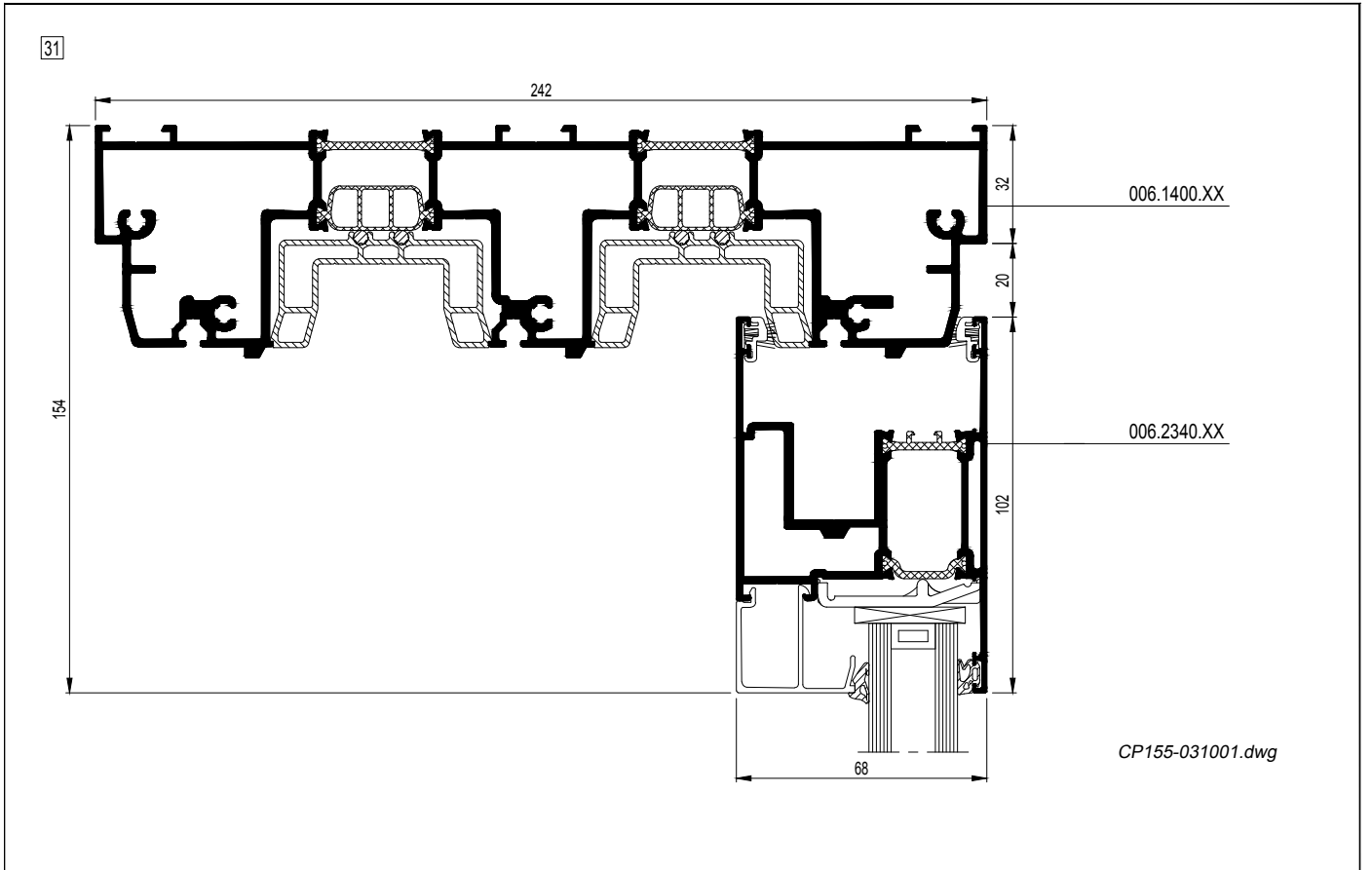
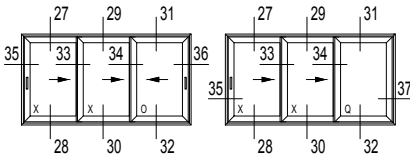

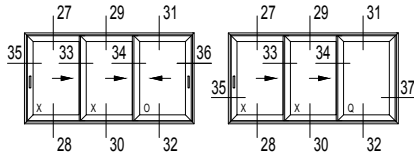

33

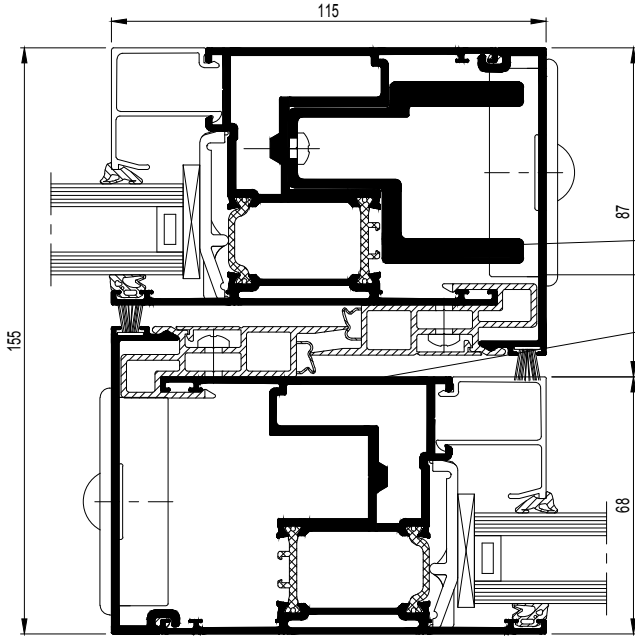

CP155-033001.dwg

34

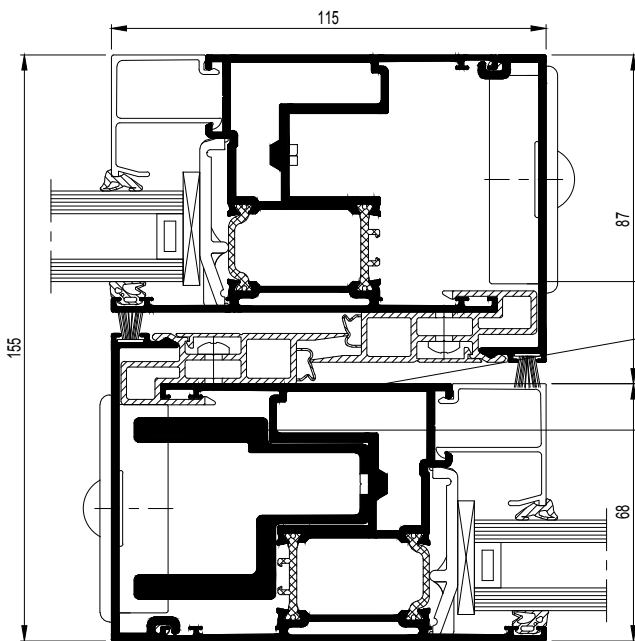

CP155-034001.dwg

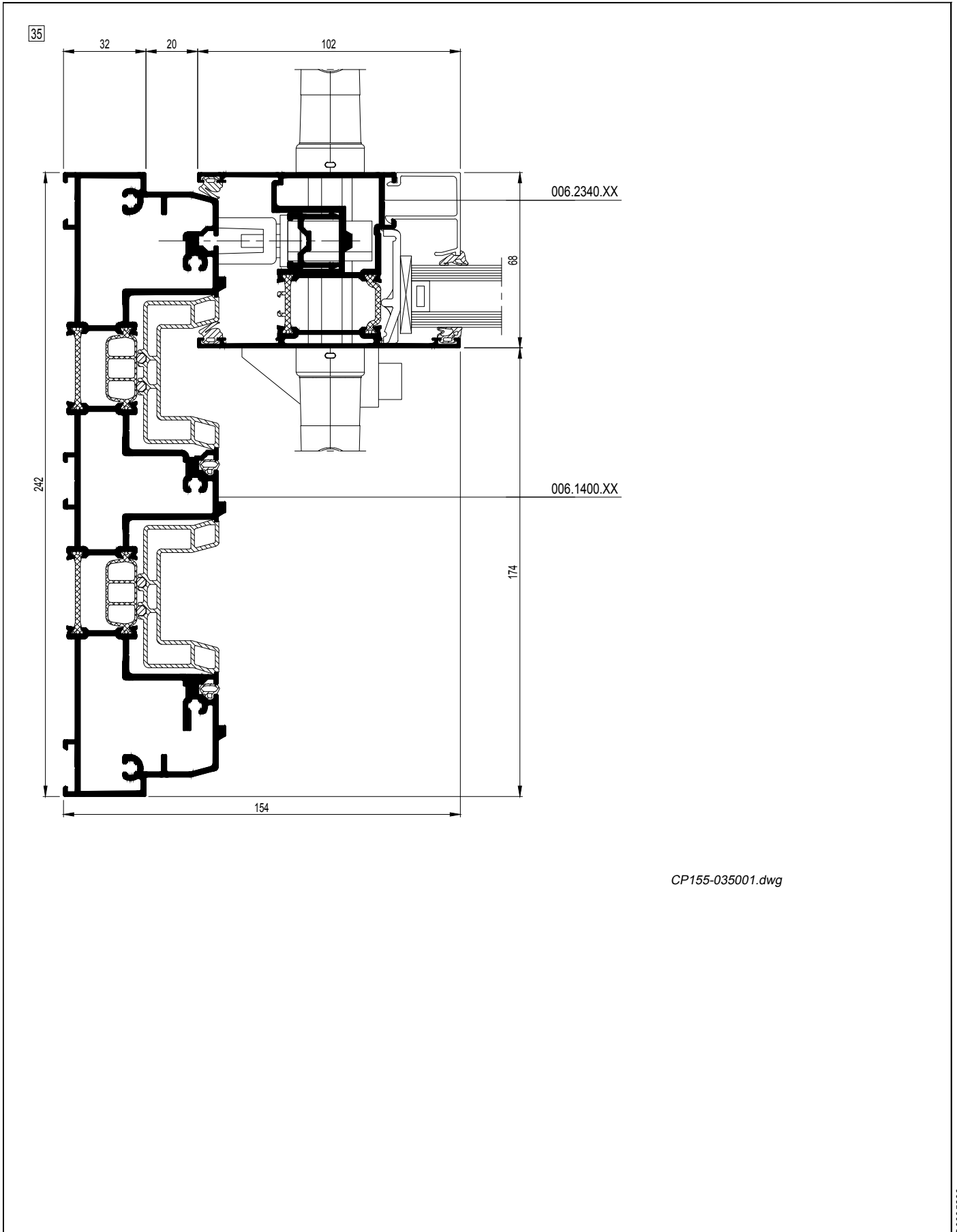
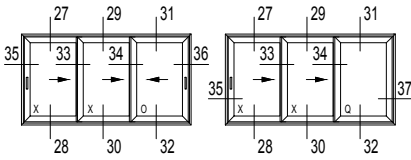

CP155-035001.dwg

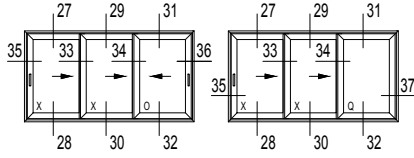

36

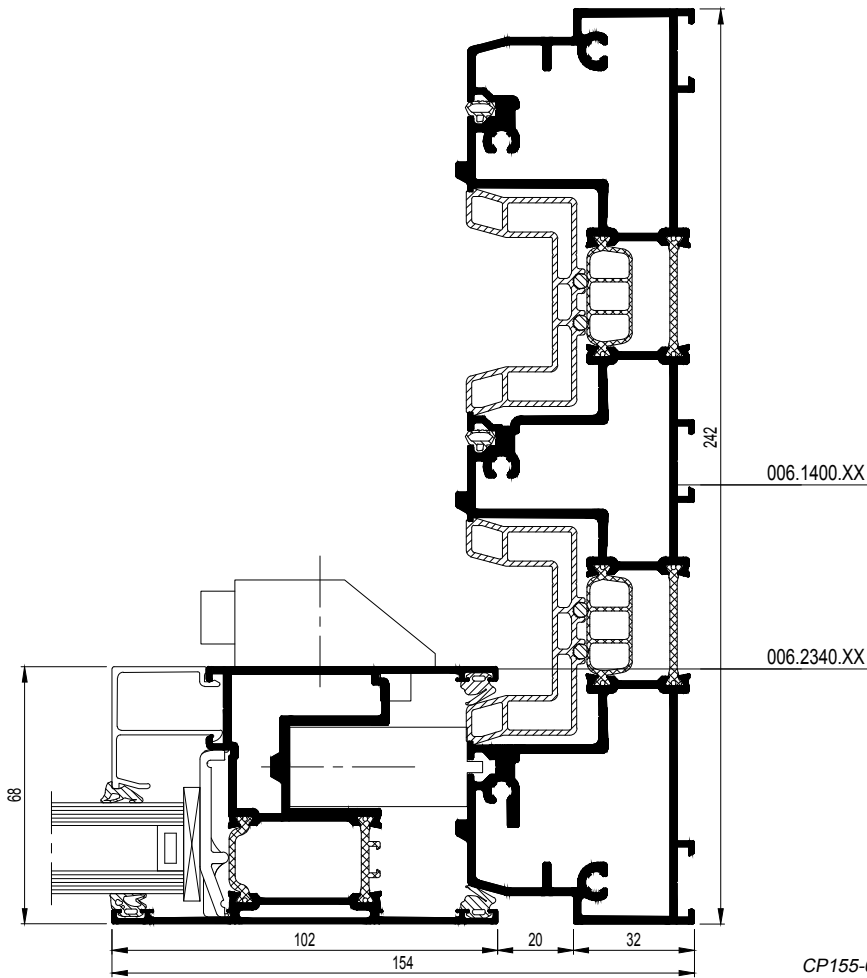

CP155-036001.dwg

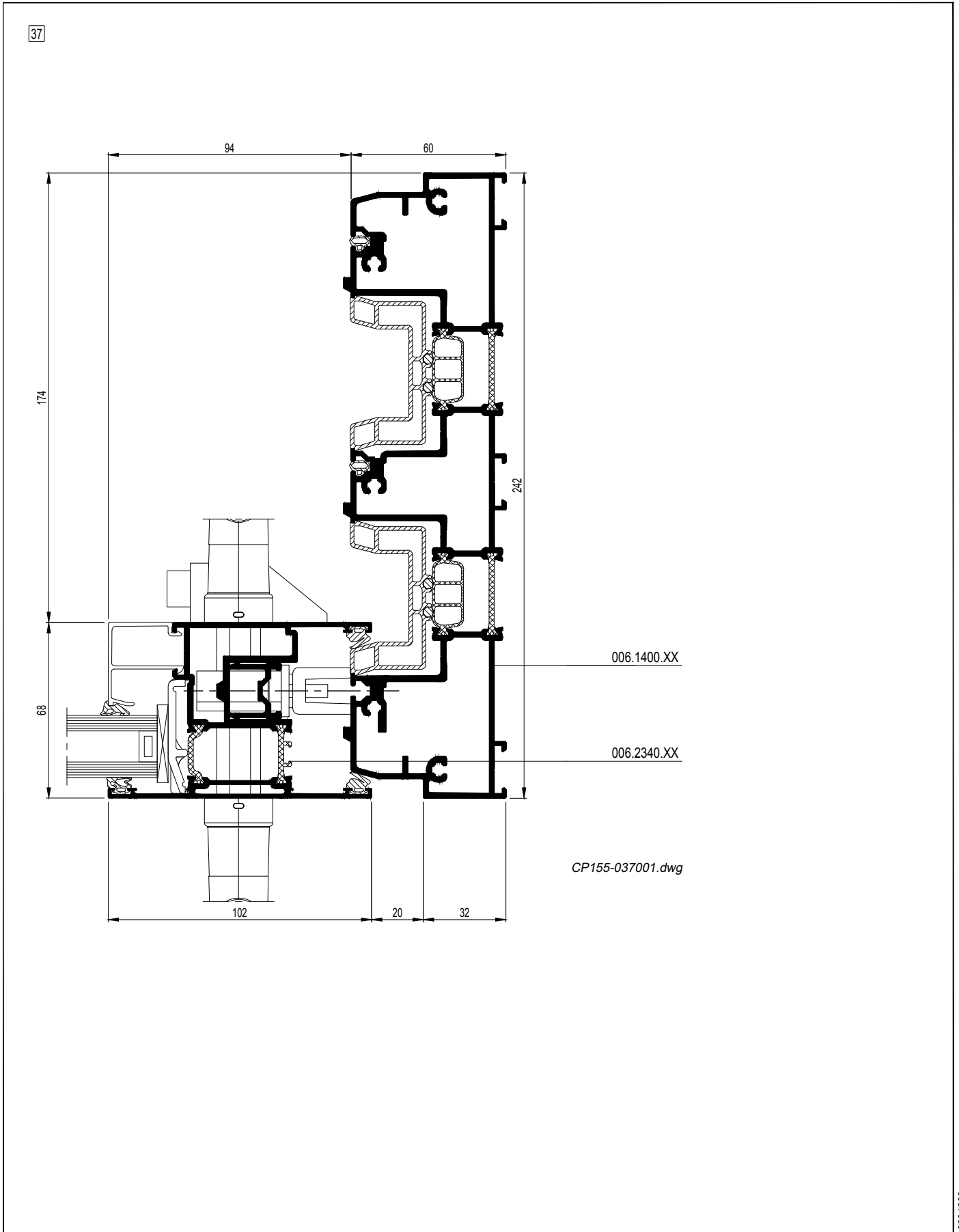
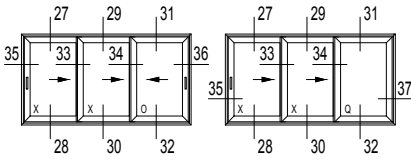

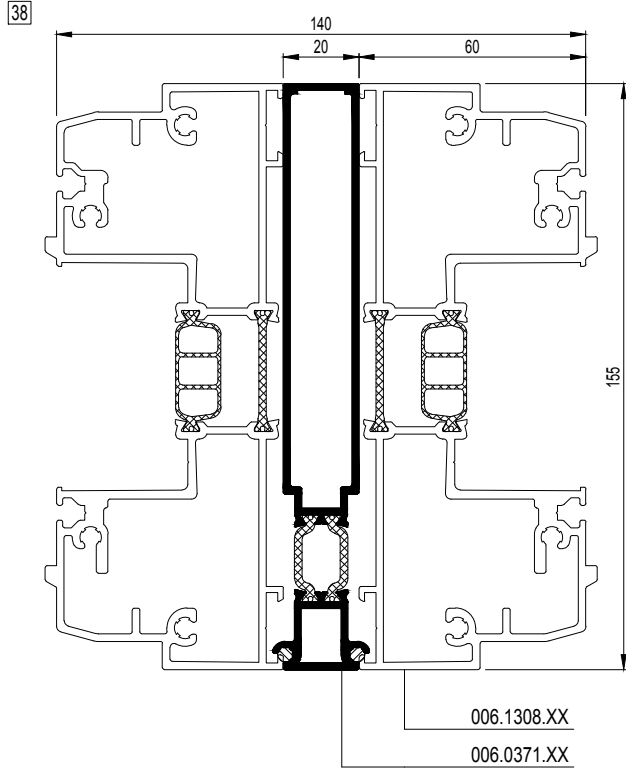
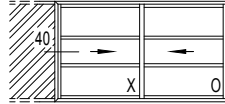
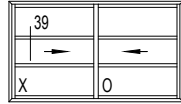
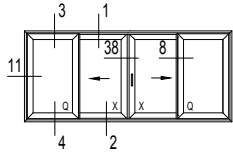

CP155-038001.dwg

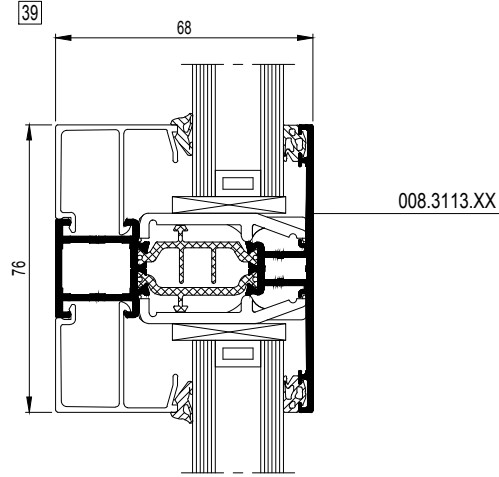

CP155-039001.dwg

008.3113.XX

$I_x = 16.962 \text{ cm}^4$

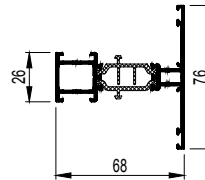

CP155-039001.dwg

008.3120.XX

$I_x = 21.513 \text{ cm}^4$

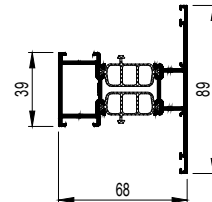

CP155-039002.dwg

008.3114.XX

$I_x = 25.337 \text{ cm}^4$

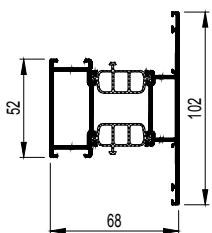

CP155-039003.dwg

008.3123.XX

$I_x = 29.162 \text{ cm}^4$

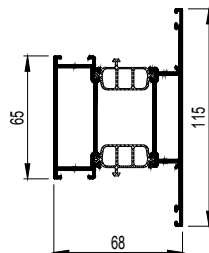

CP155-039004.dwg

008.3824.XX

$I_x = 59.548 \text{ cm}^4$

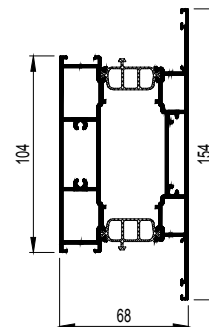

CP155-039005.dwg

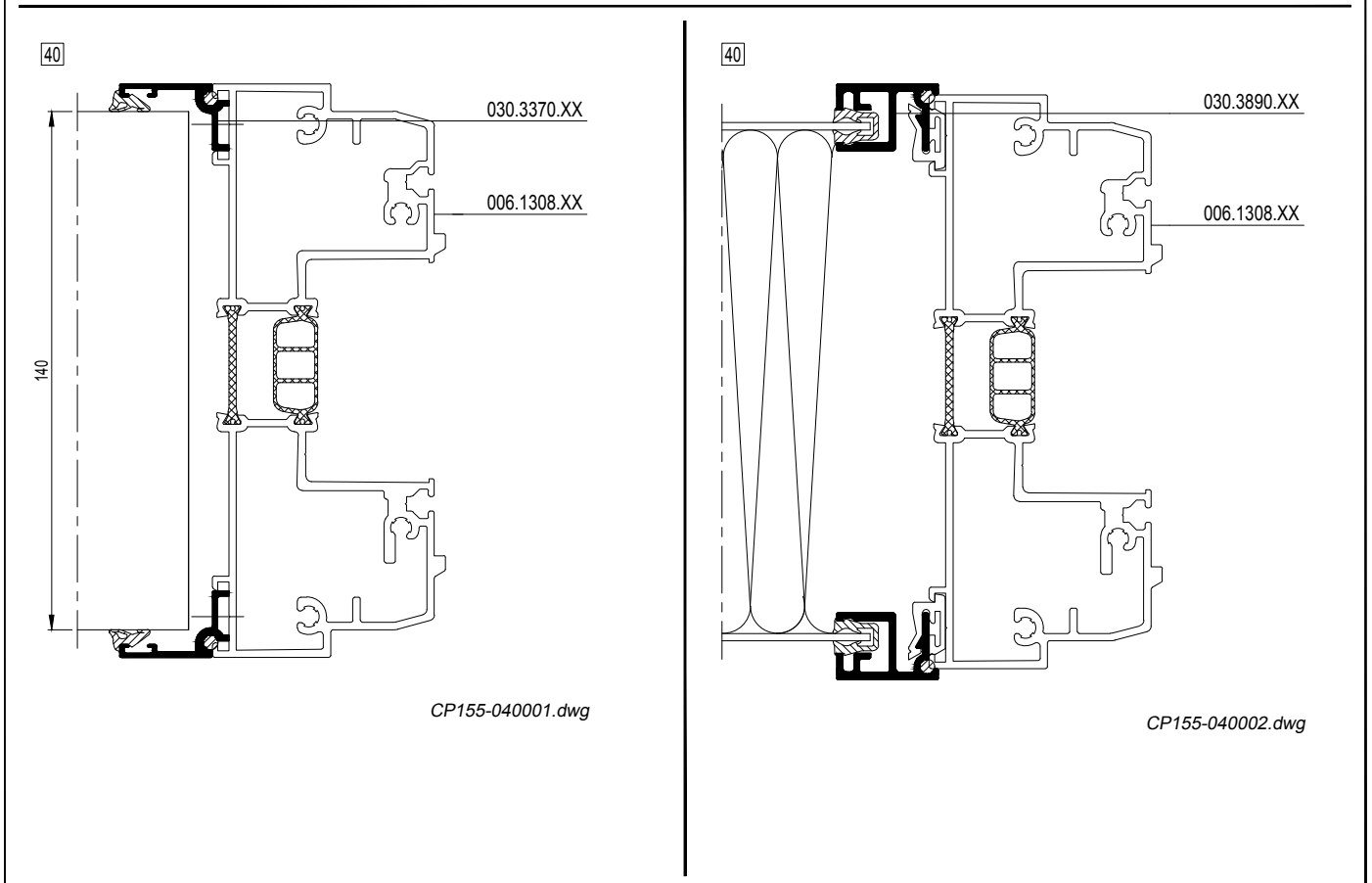
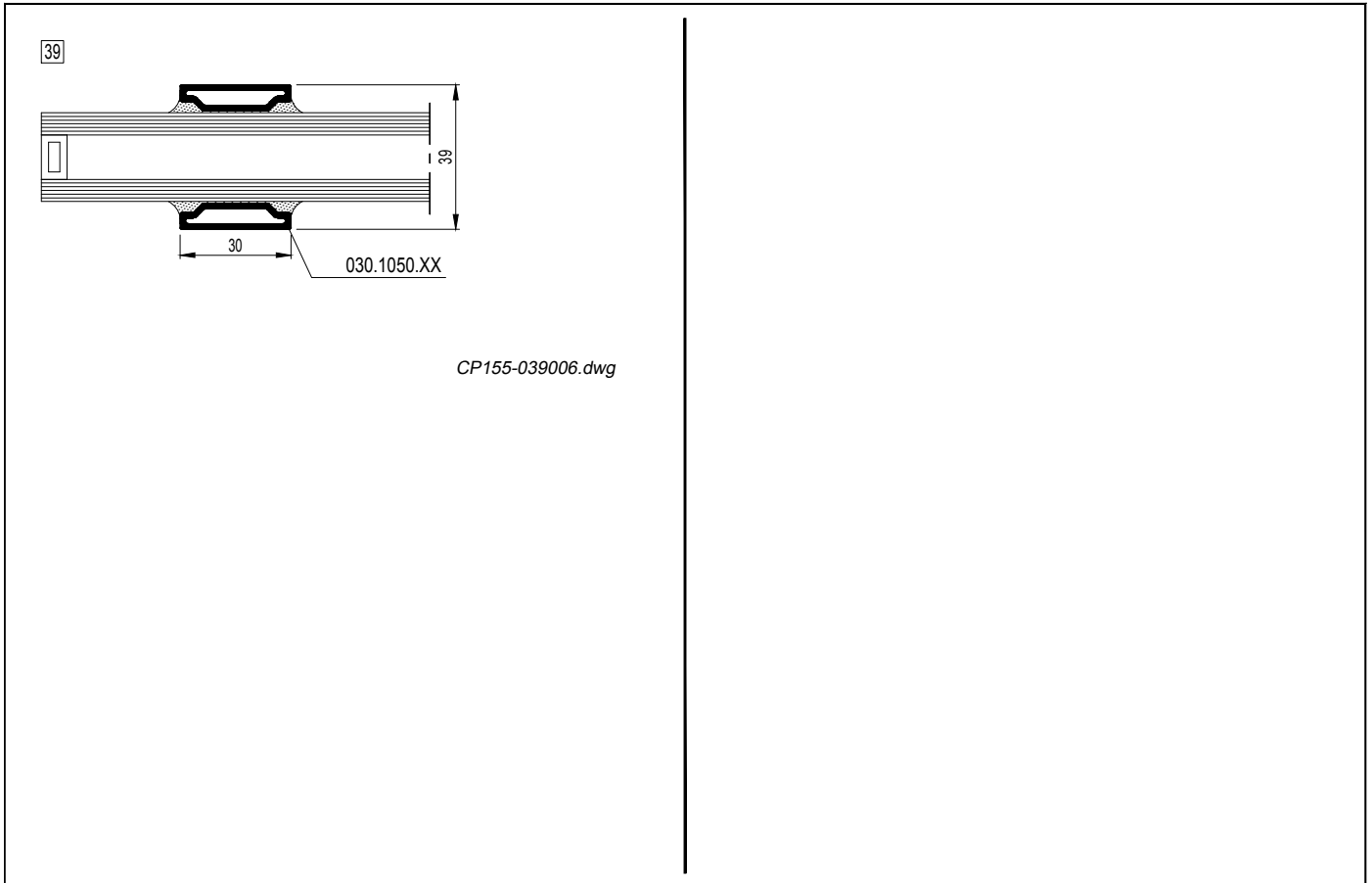
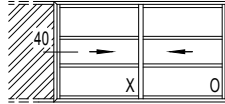
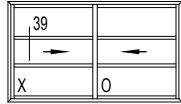
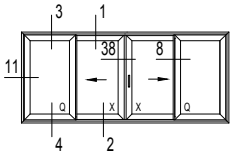

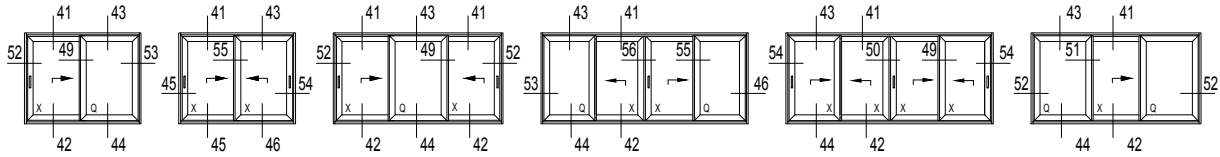

41

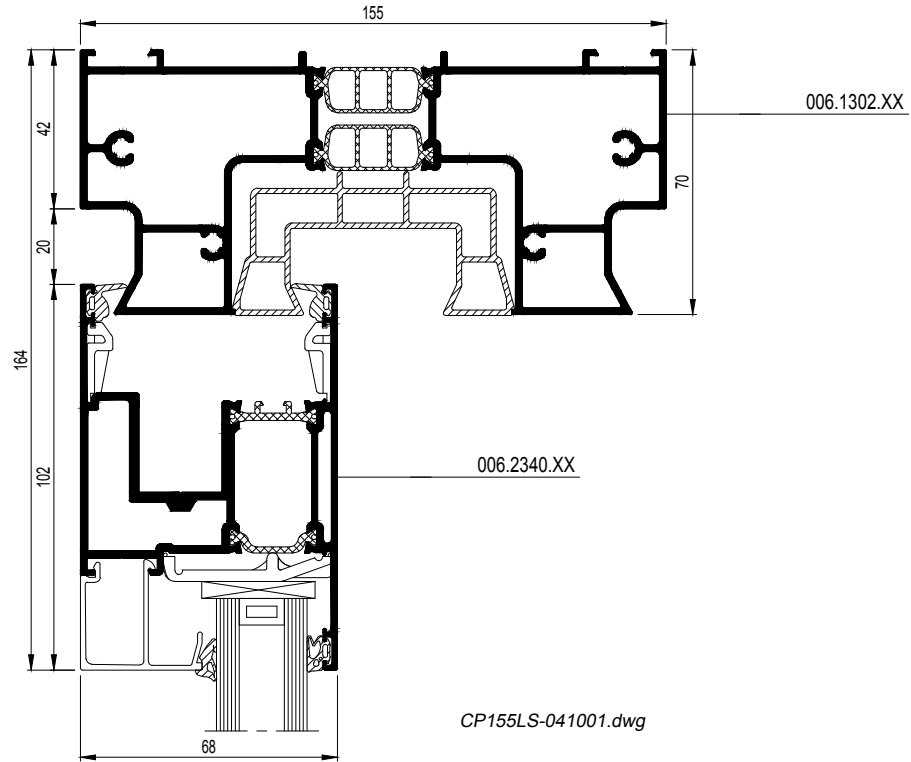

42

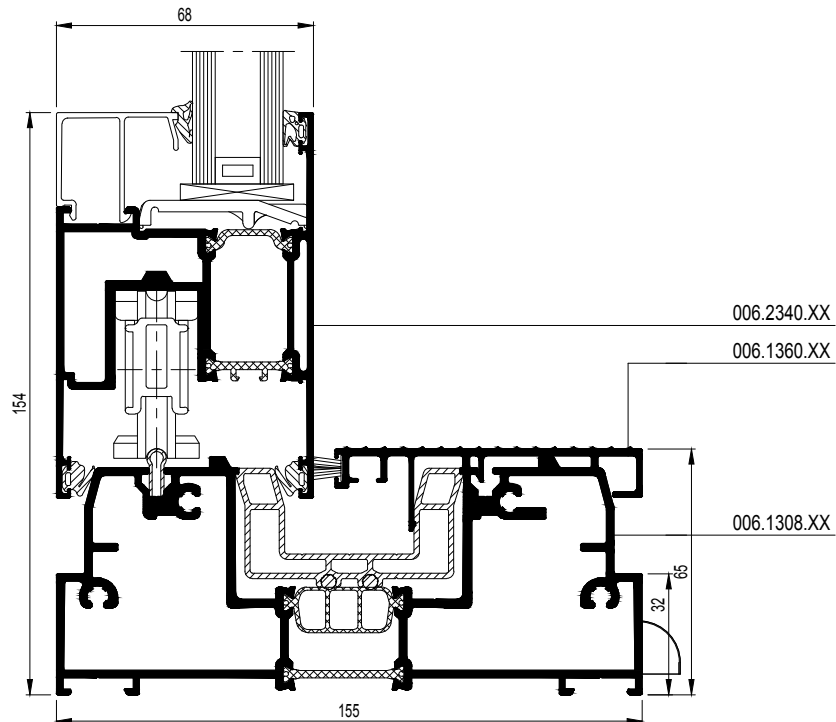

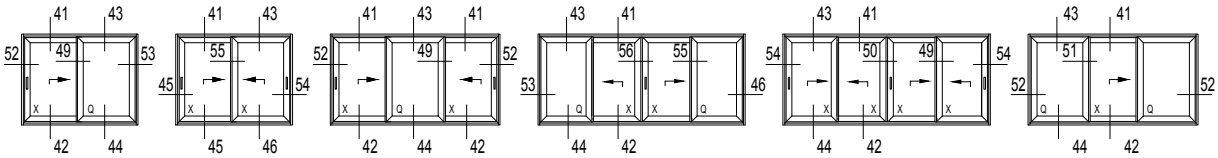

43

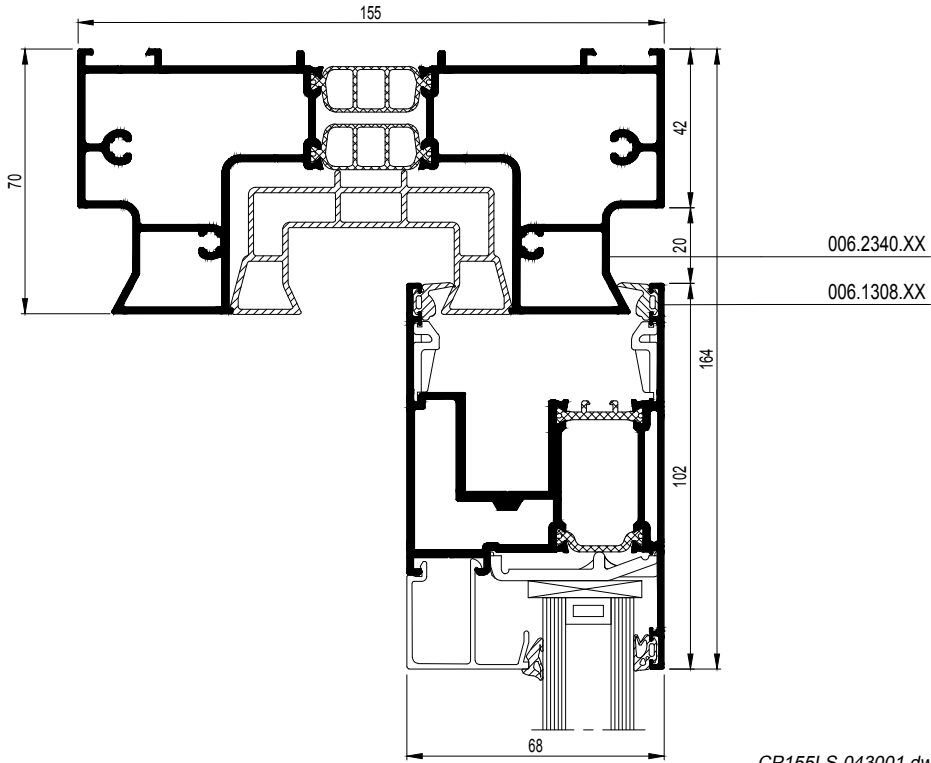

44

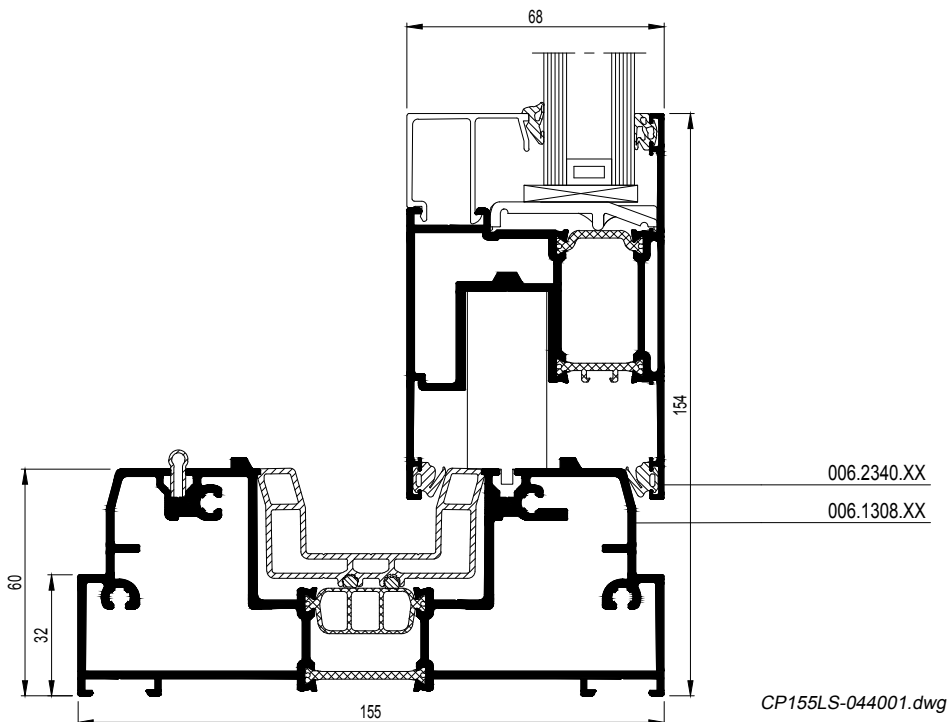

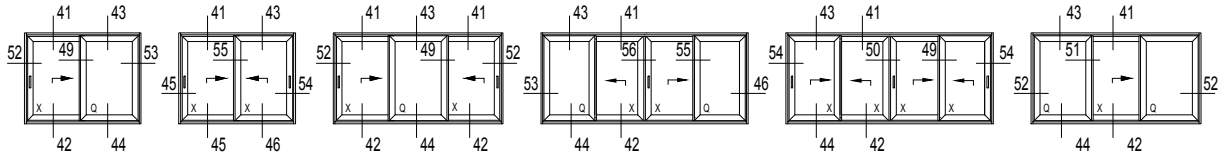

45

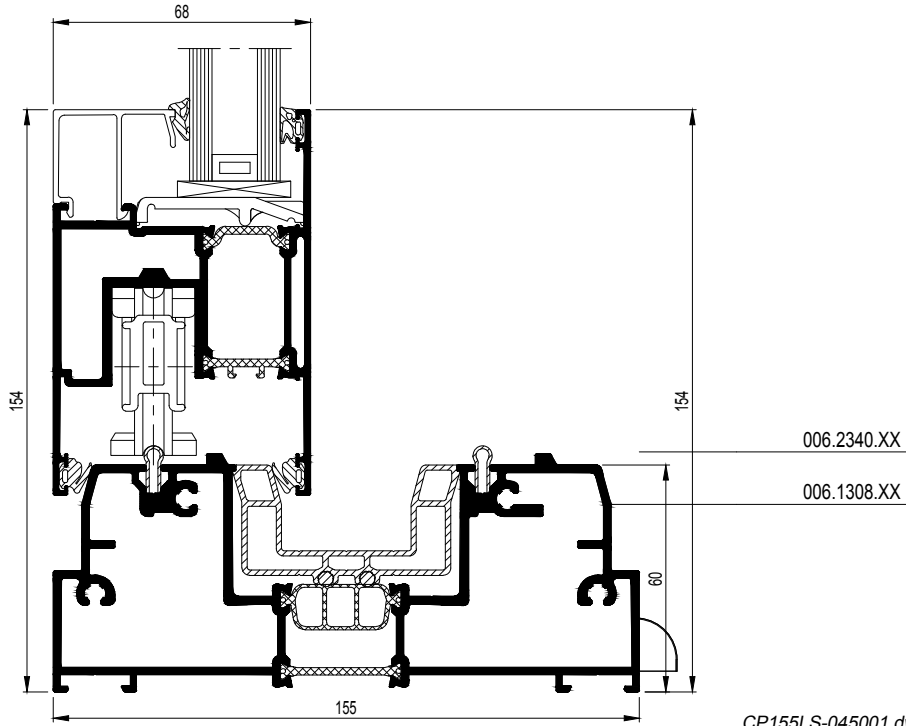

CP155LS-045001.dwg

46

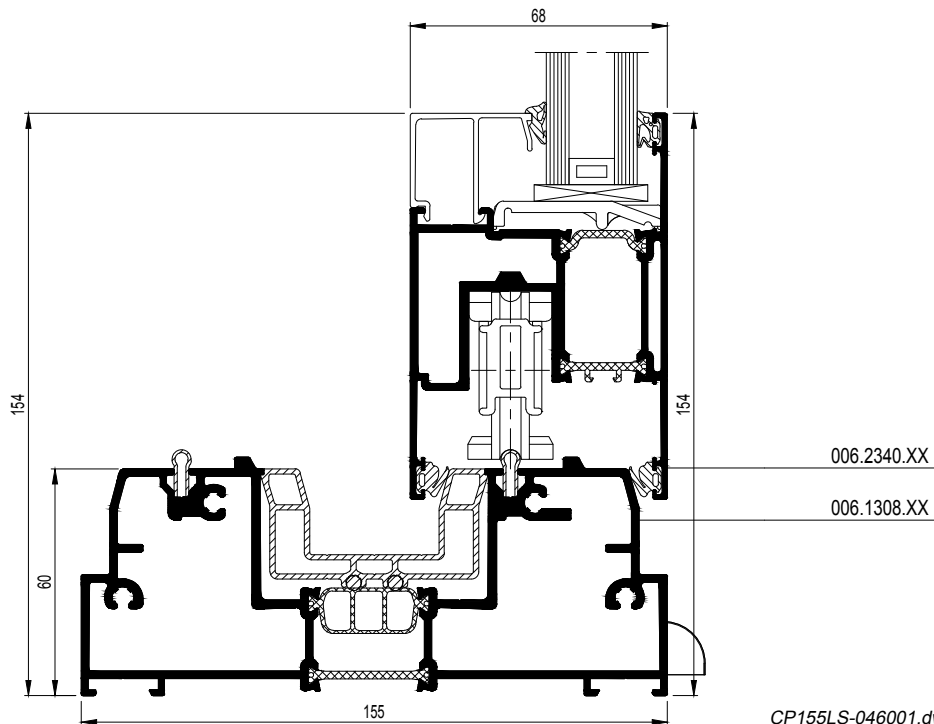

CP155LS-046001.dwg

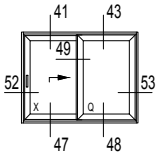

47 Max. 150Pa

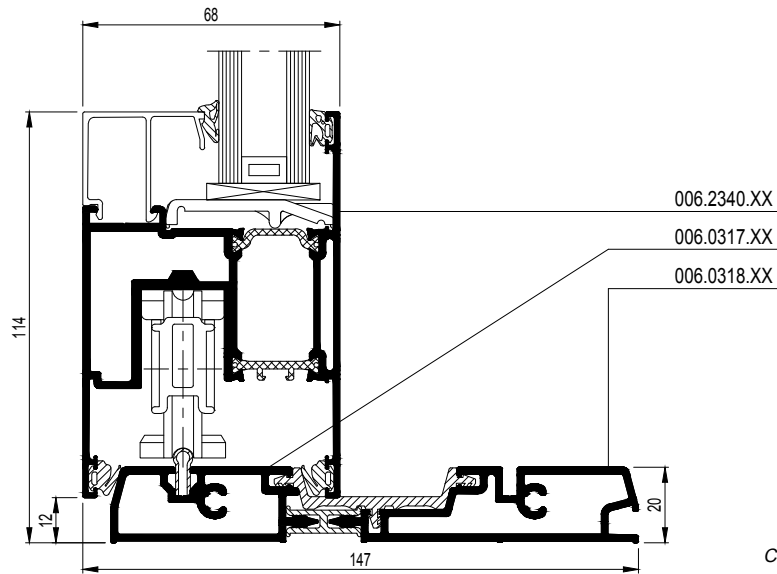

CP155LS-058001.dwg

48 Max. 150Pa

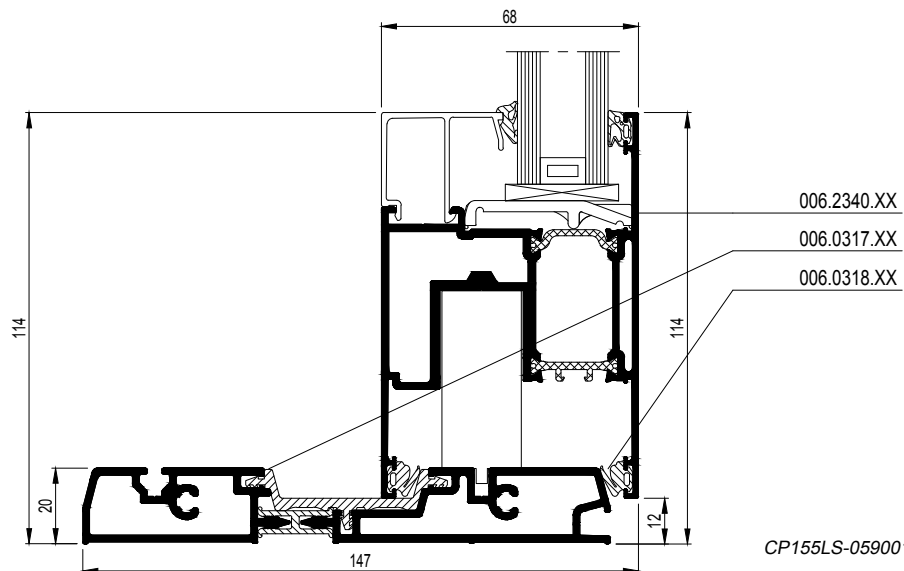

CP155LS-059001.dwg

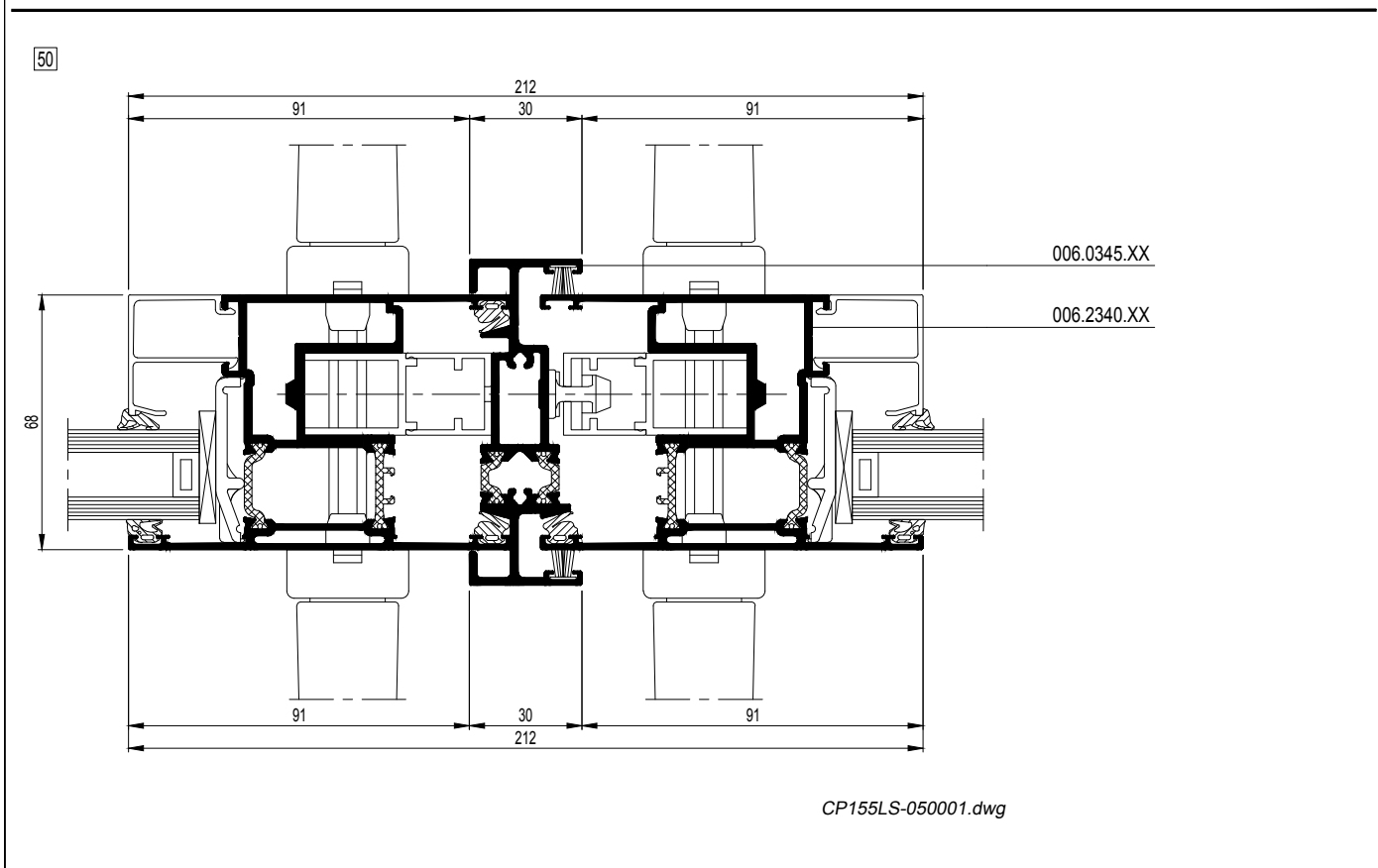
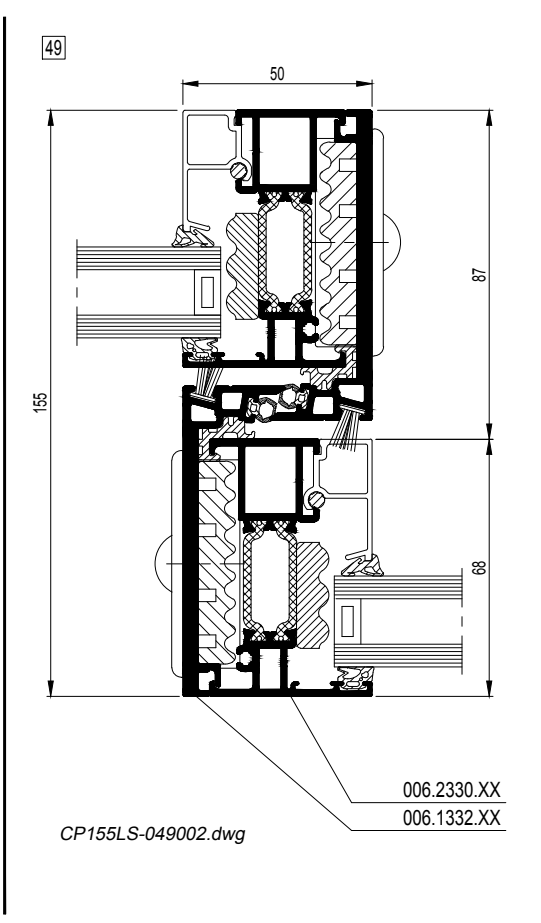
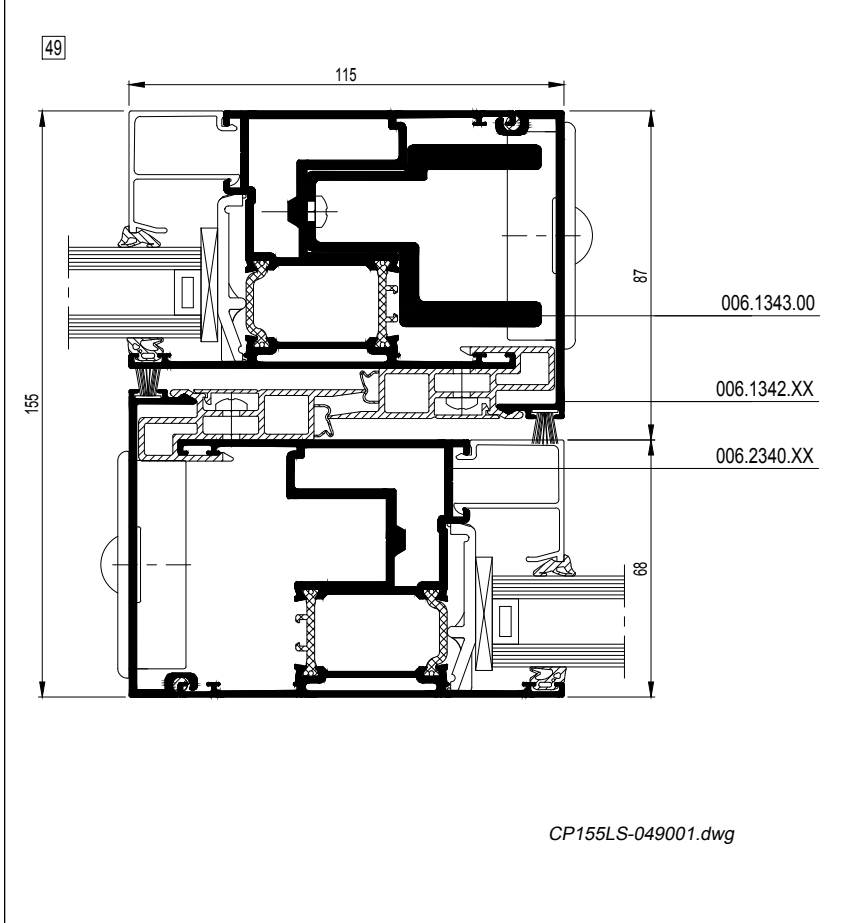
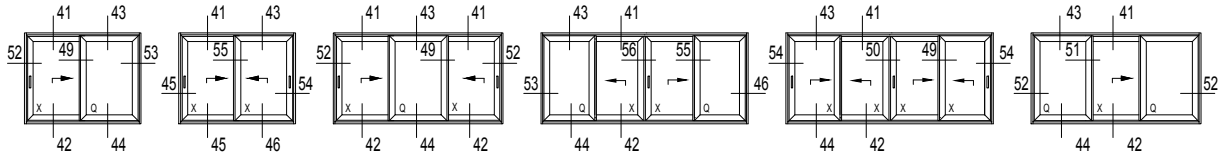

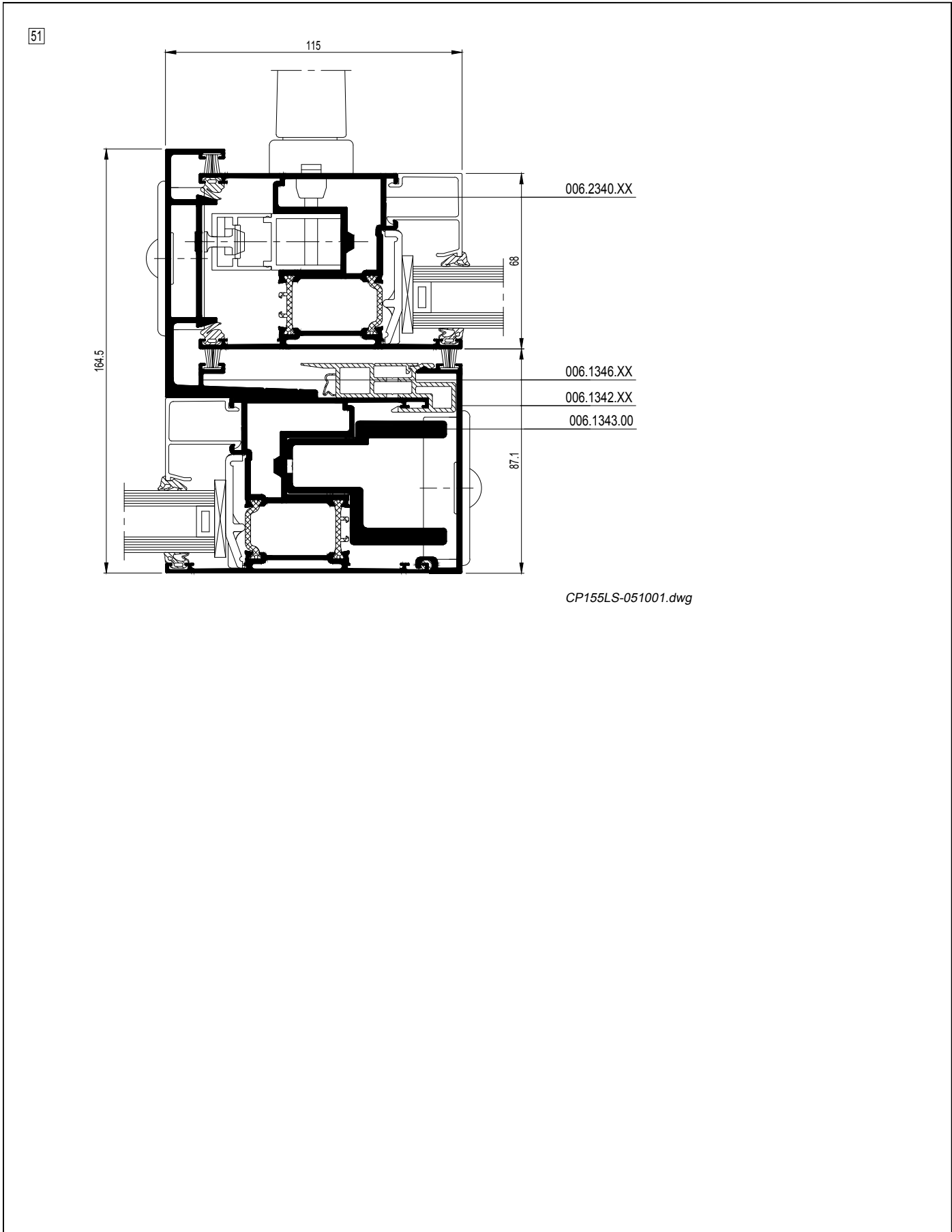
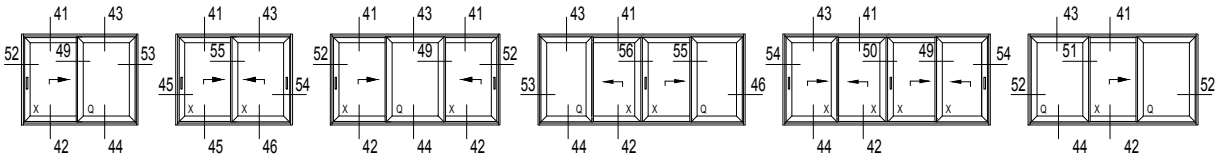

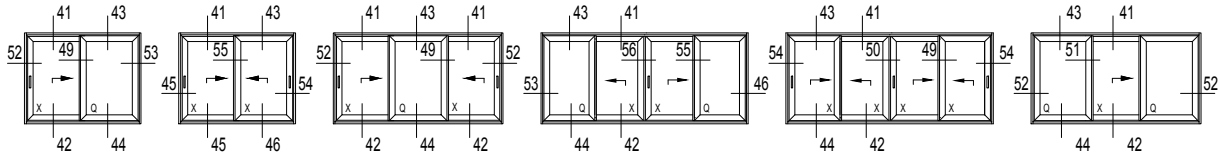

52

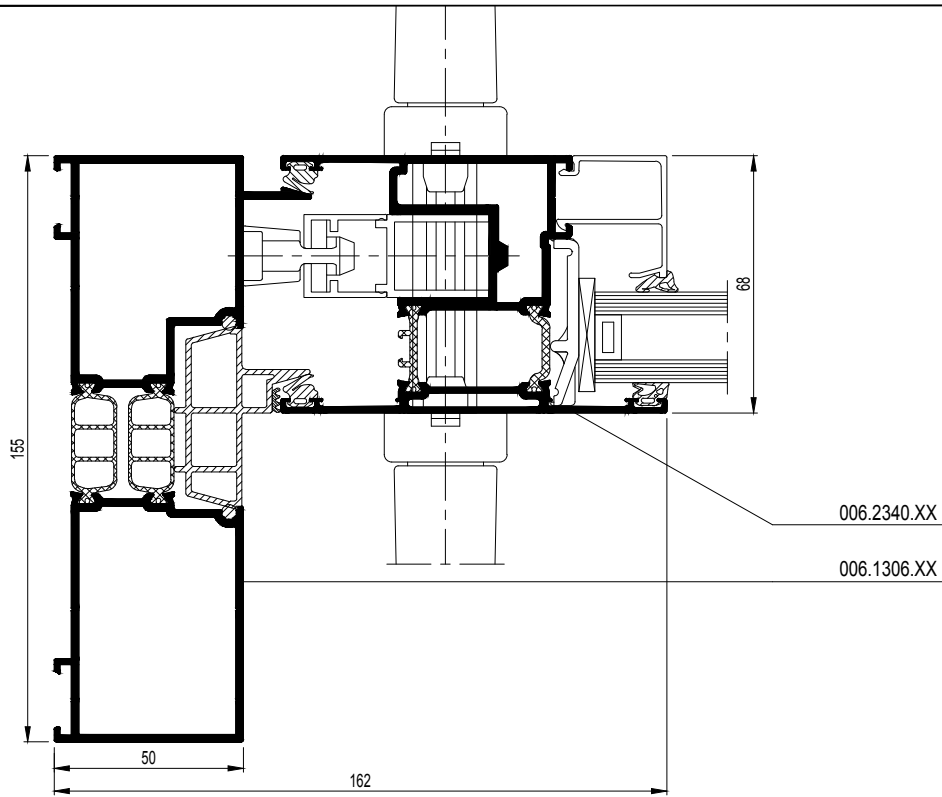

CP155LS-052001.dwg

52

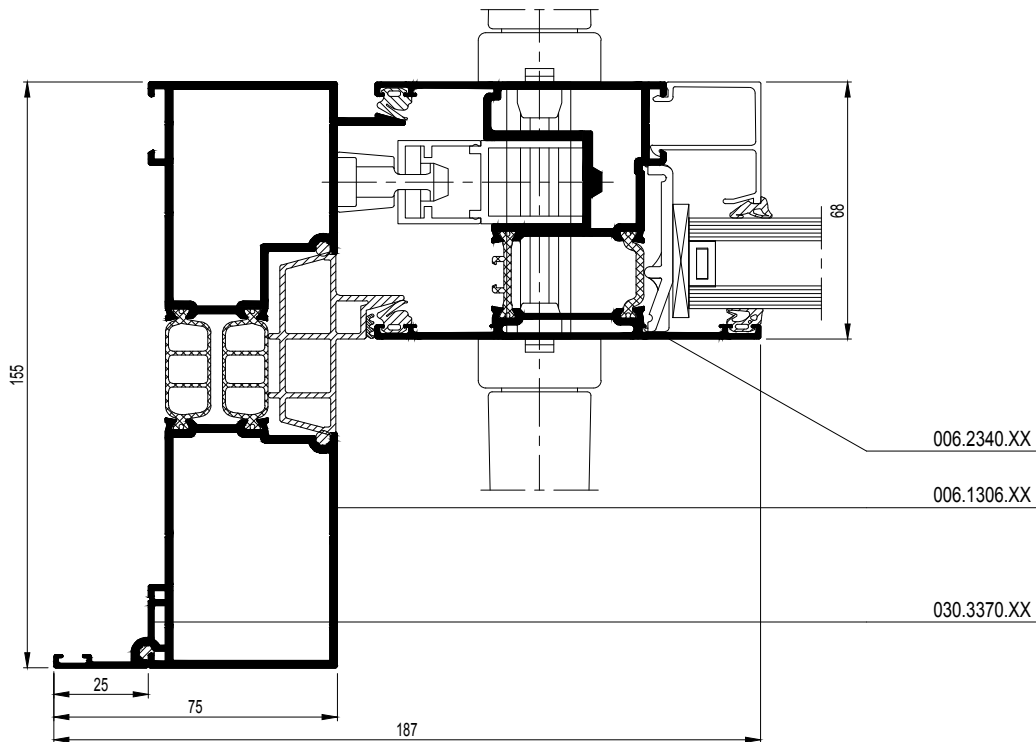

CP155LS-052002.dwg

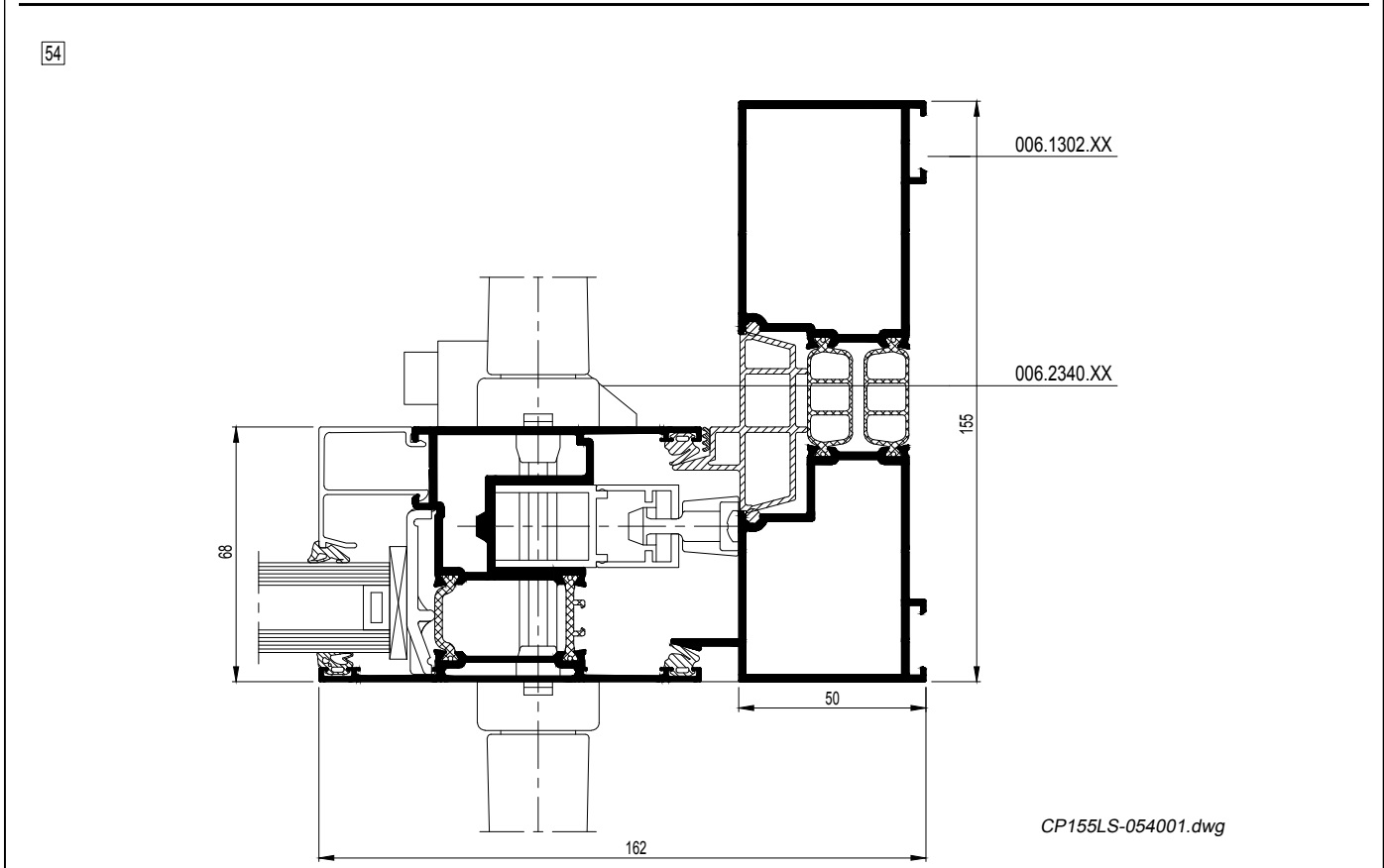
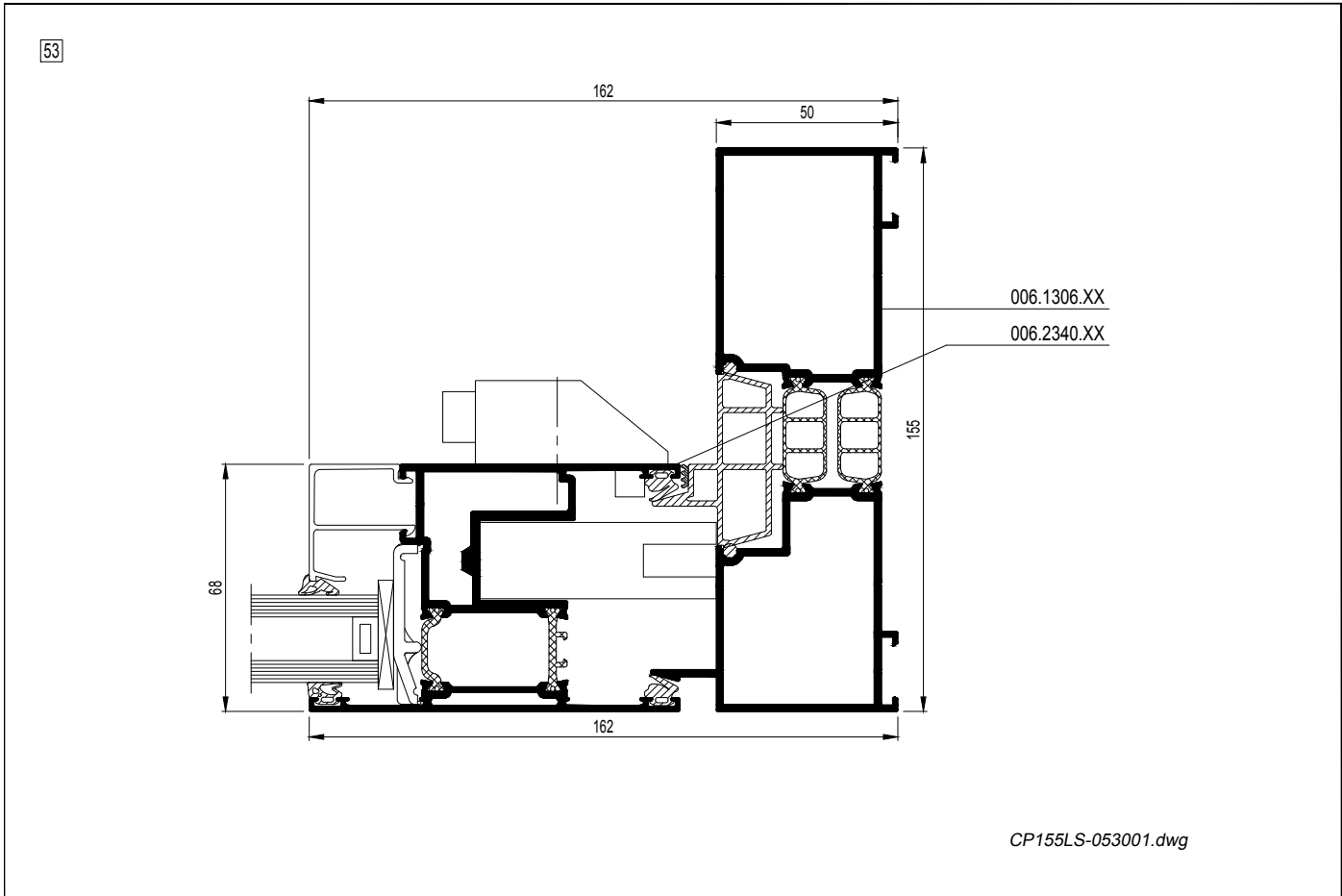
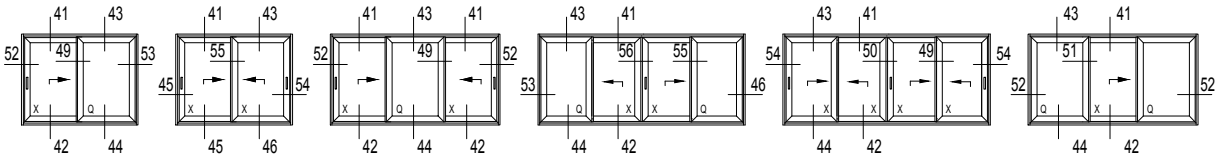

CP 155-LS

OPENGAANDE ELEMENTEN (DUORAIL) - BUITENKADERS
ELEMENTS OUVRANTS (DUORAIL) - DORMANTS
OPENING ELEMENTS (DUORAIL) - OUTER FRAMES
OEFFNENDE ELEMENTE (DOURAIL) - BLENDRAHMEN

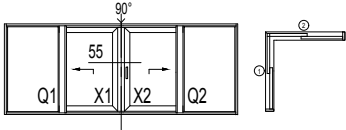

55

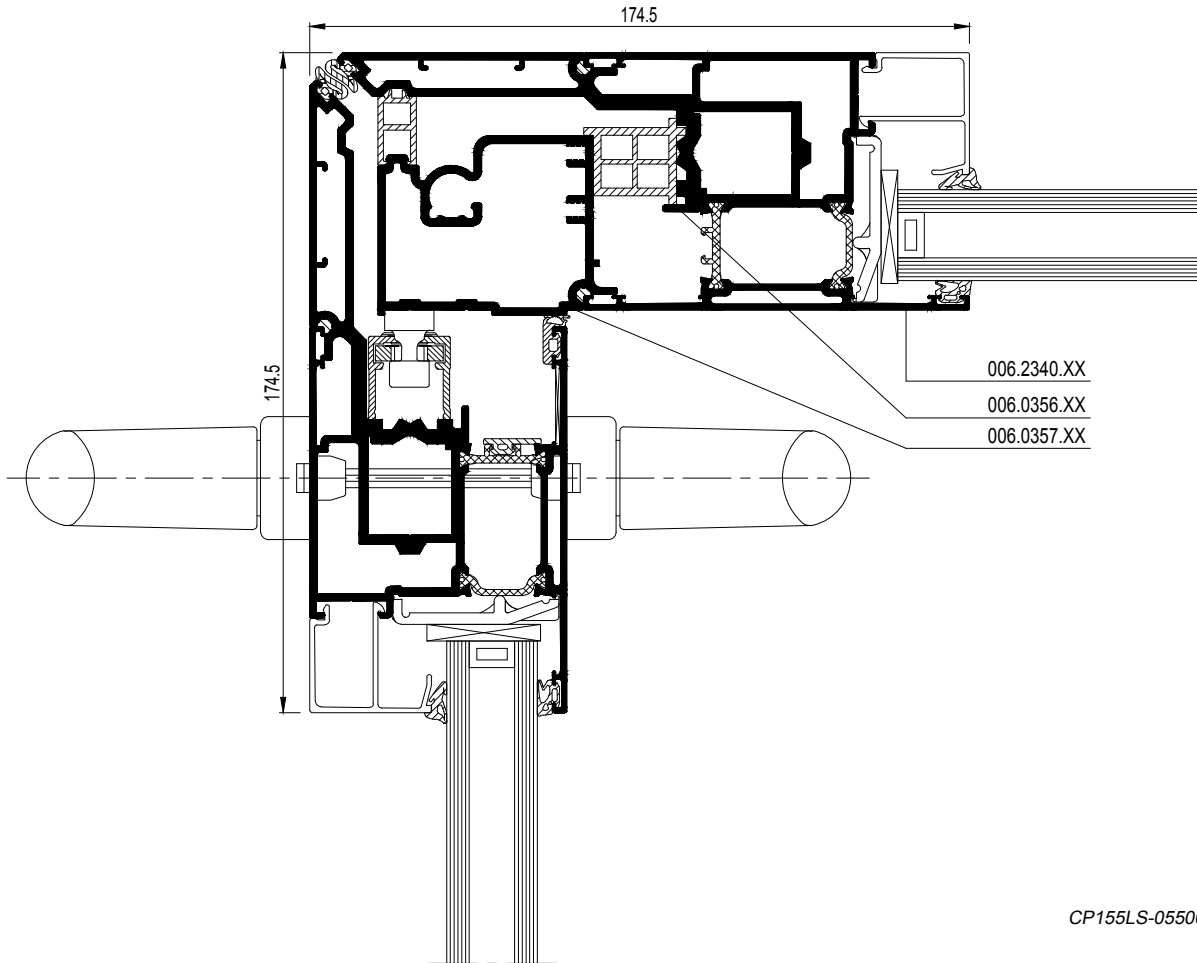

CP155LS-055001.dwg

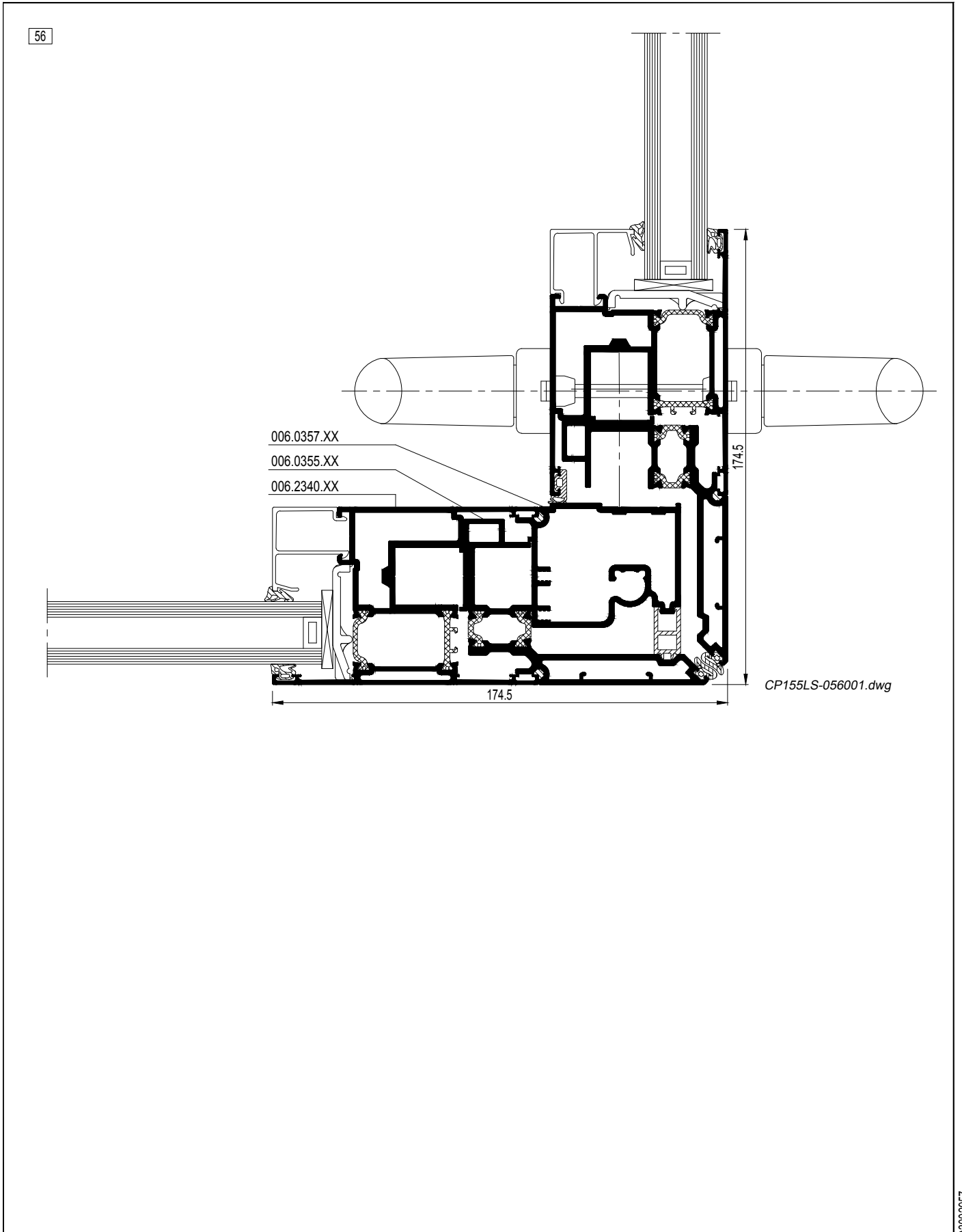
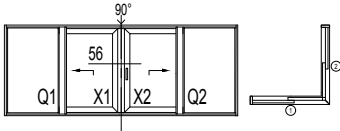

CP 155-LS

OPENGAANDE ELEMENTEN (DUORAIL) - AUTOMATISCHE HEFSCHUIFDEUR
ELEMENTS OUVRANTS (DUORAIL) - SOULEV. COULISSANT AUTOMATIQUE
OPENING ELEMENTS (DUORAIL) - AUTOMATIC LIFT AND SLIDING DOOR
OEFFNENDE ELEMENTE (DOURAIL) - AUTOMATISCHE HEBESCHIEBETUER

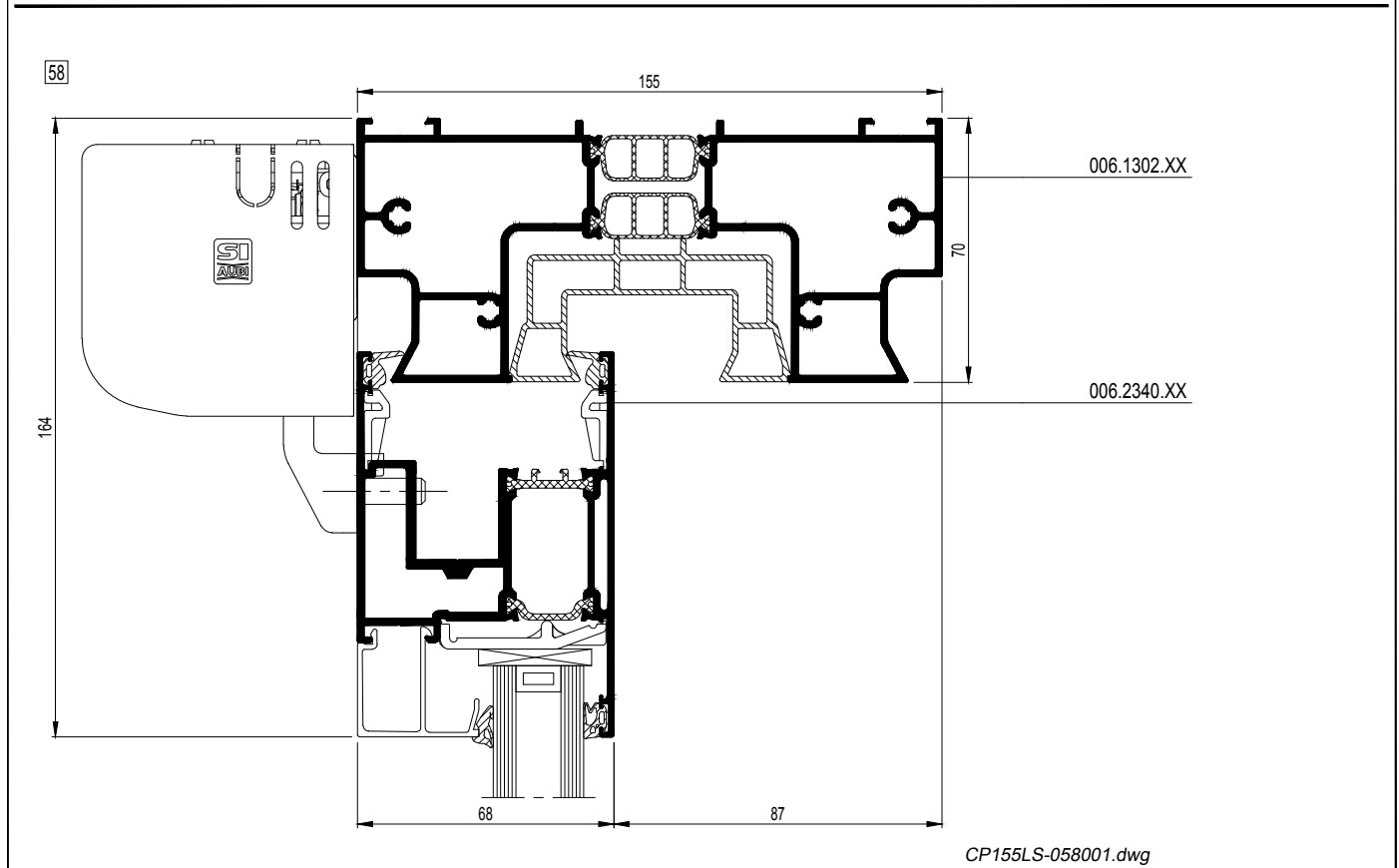
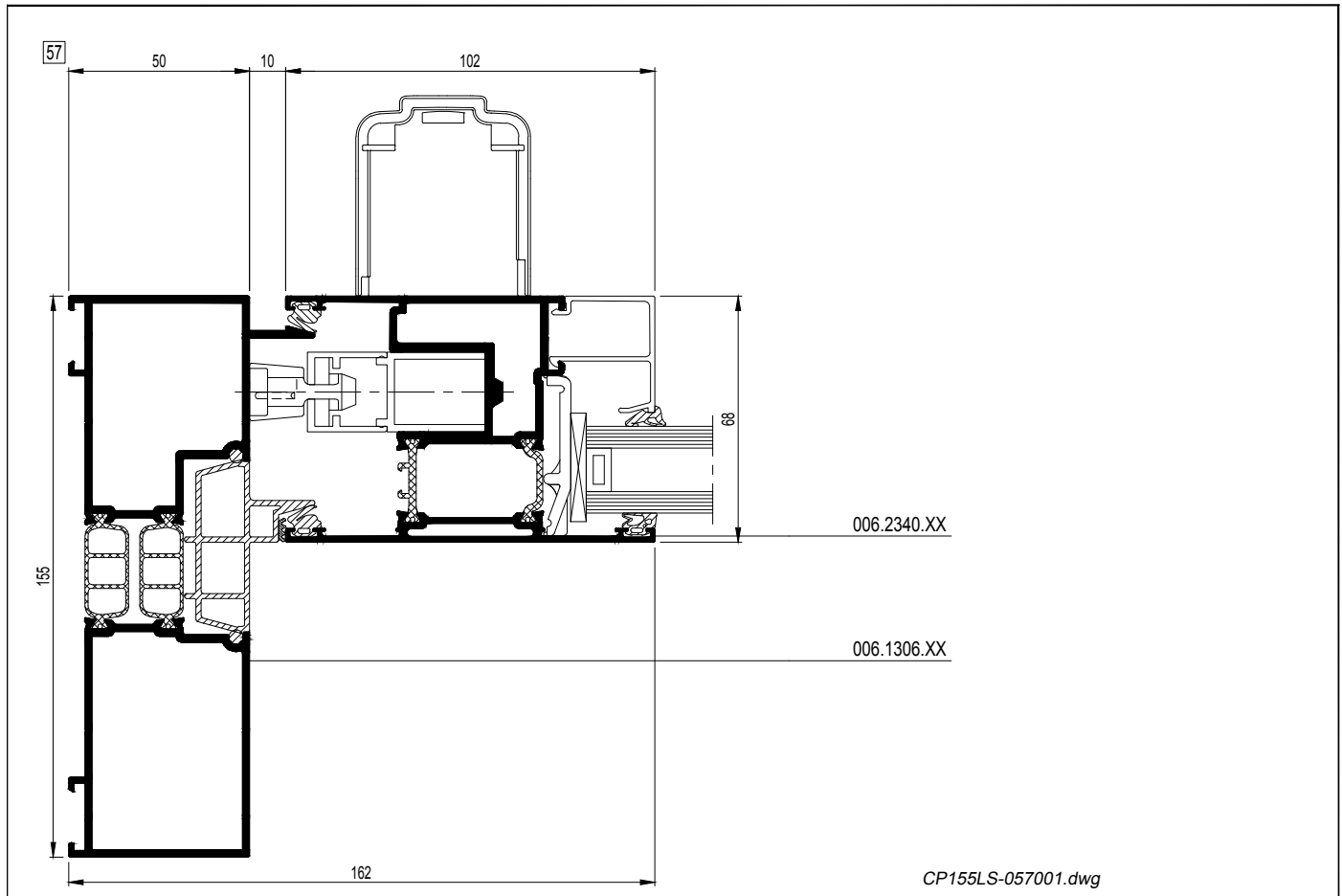
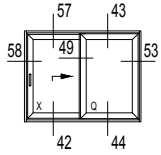

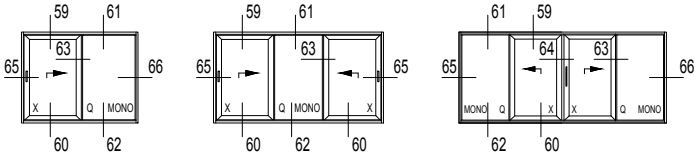

59

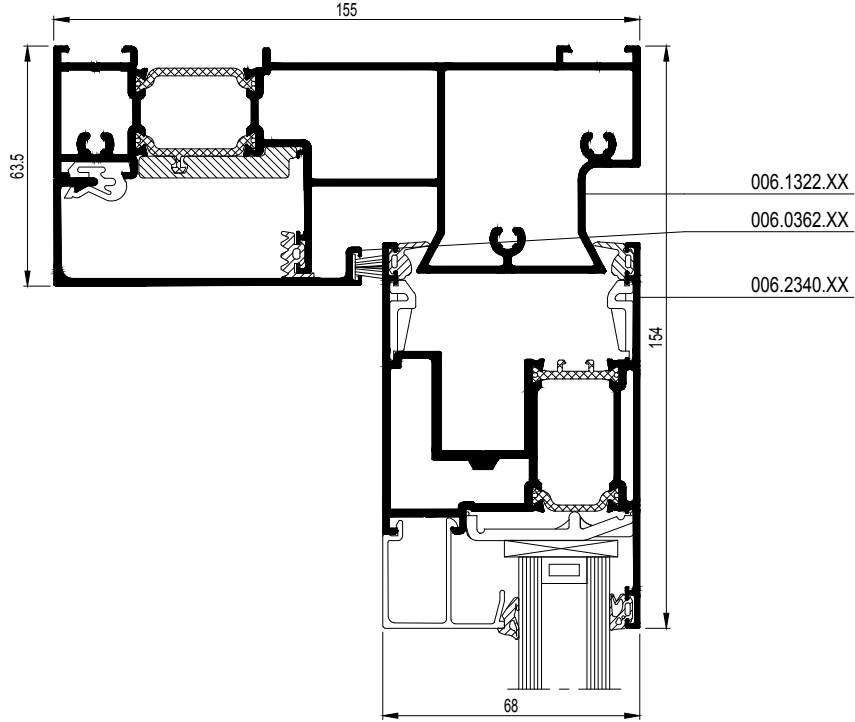

CP155LS-059001.dwg

60

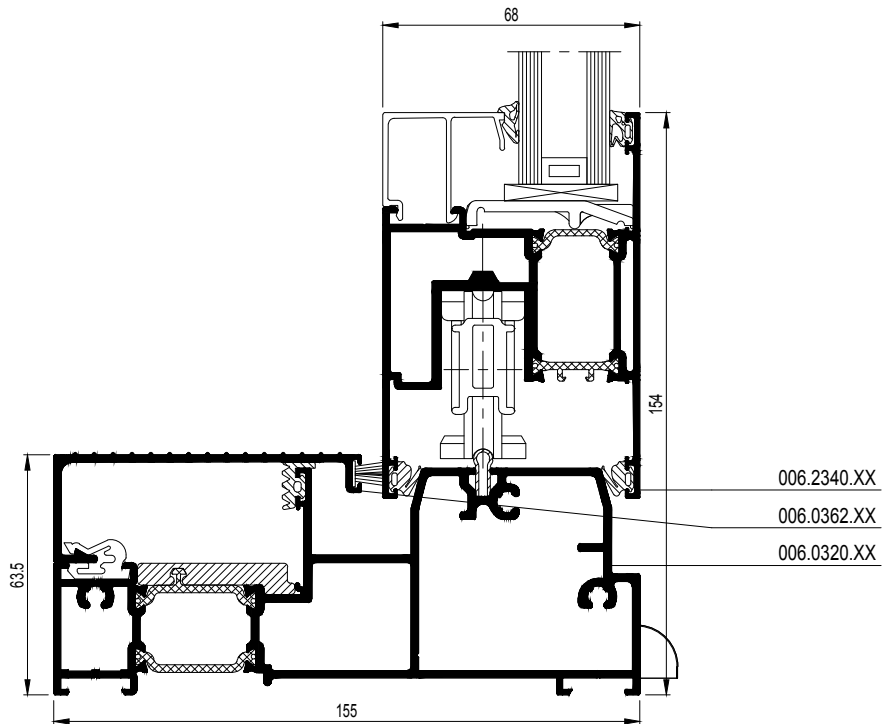

CP155LS-060001.dwg

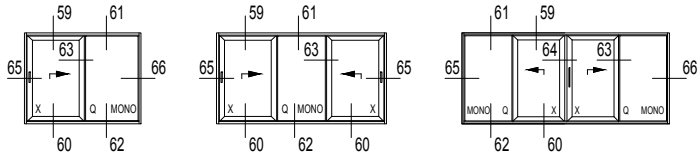

61

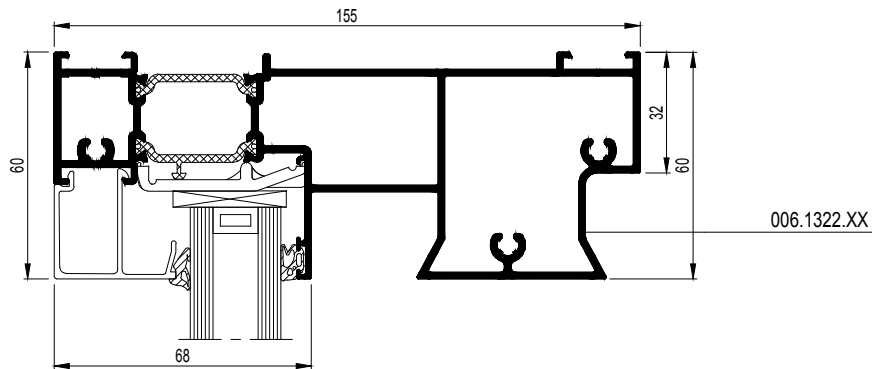

CP155LS-061001.dwg

62

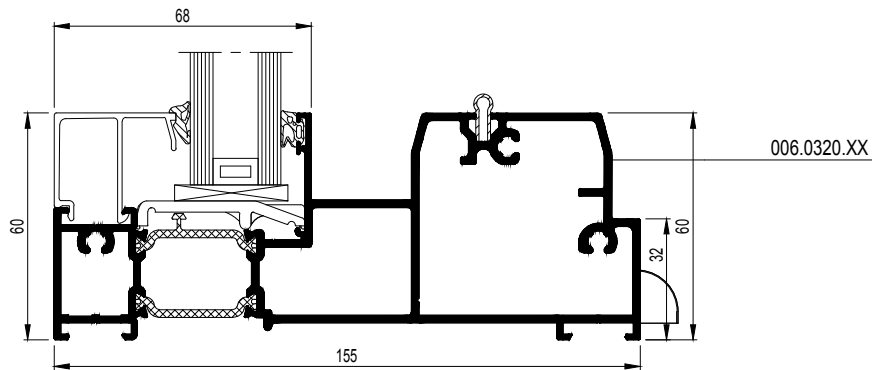

CP155LS-062001.dwg

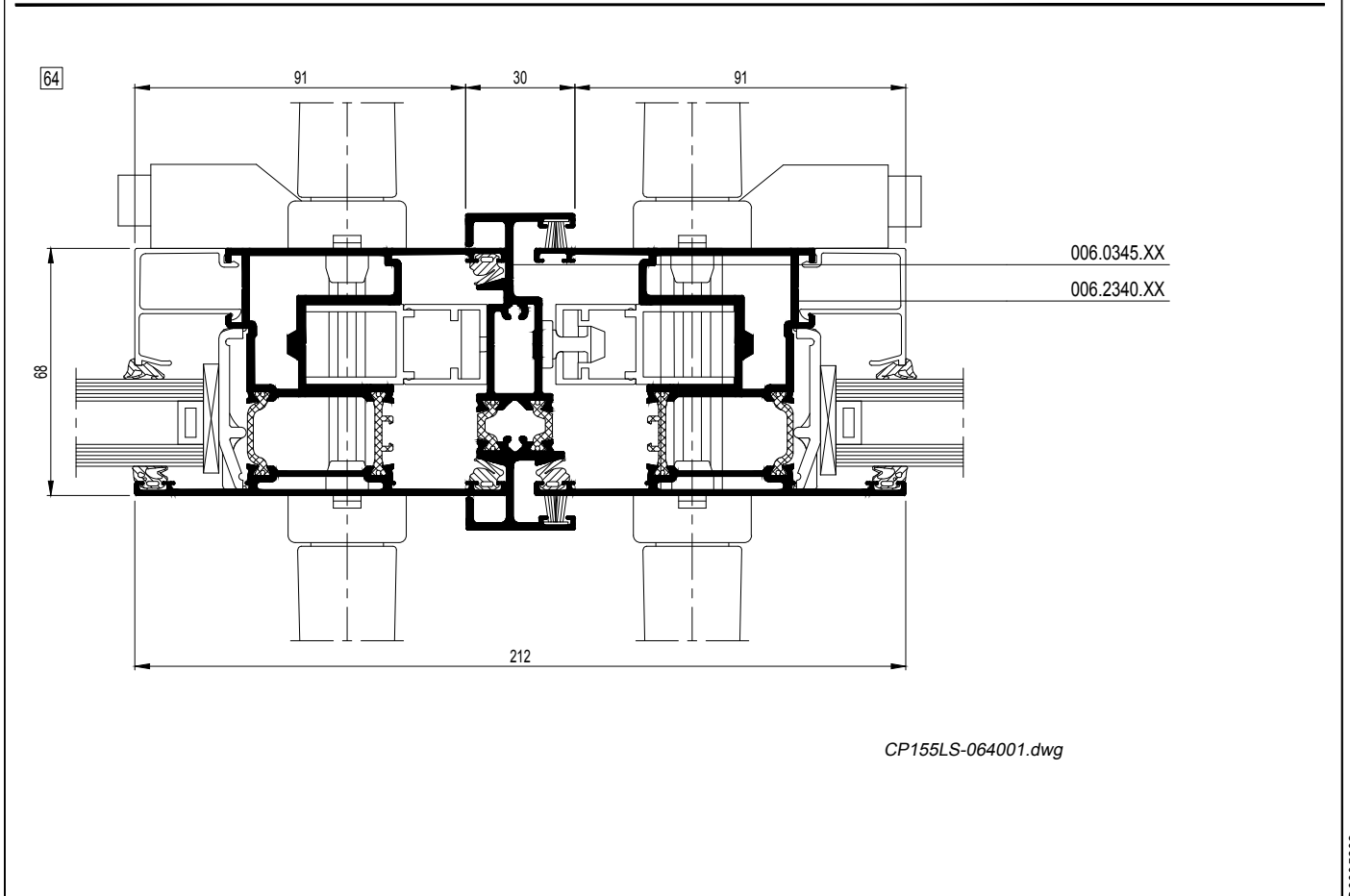
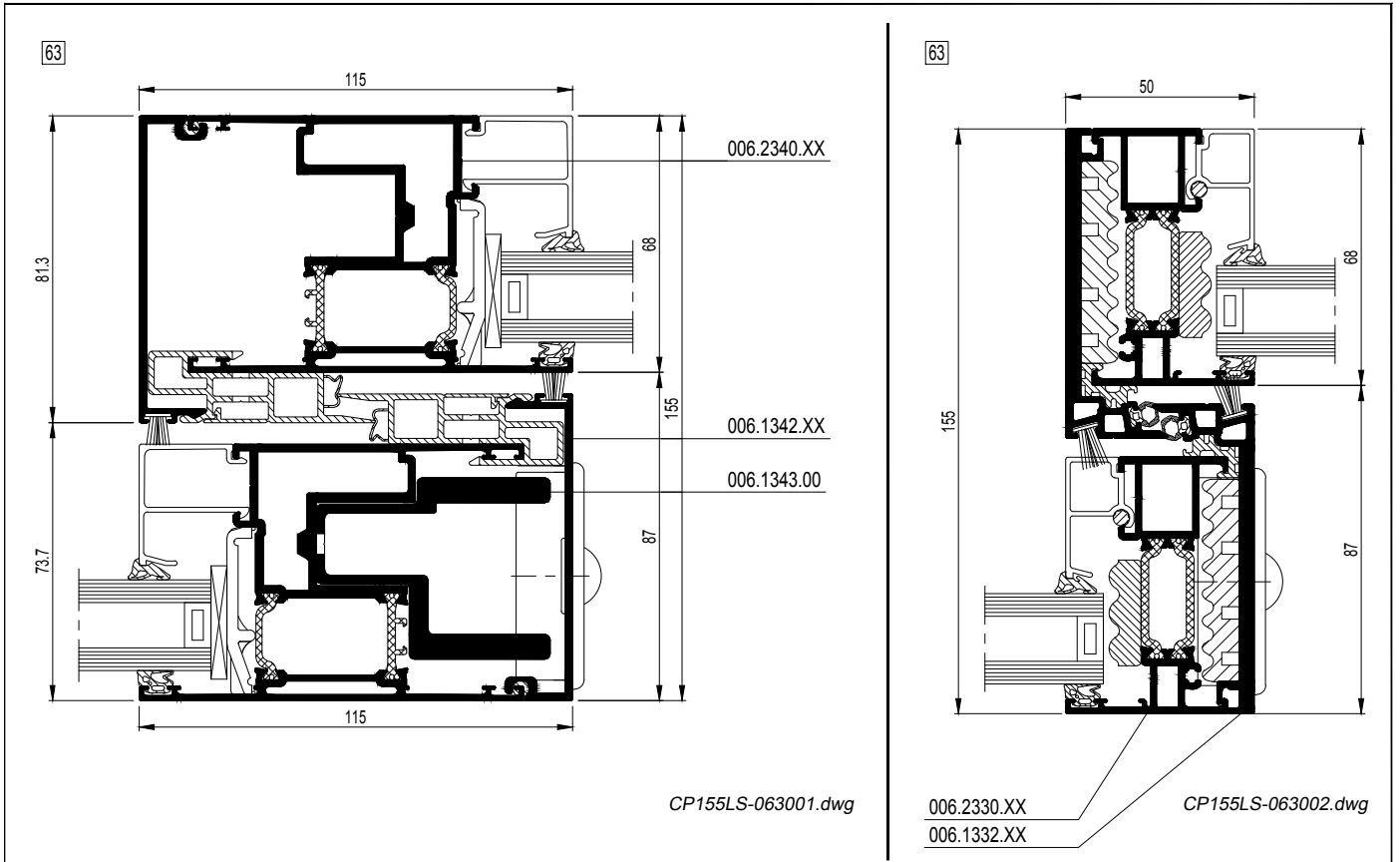
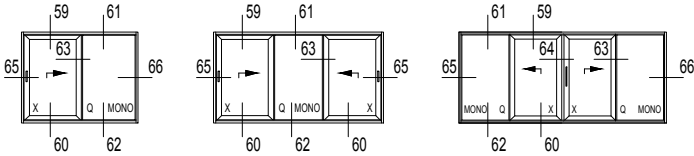

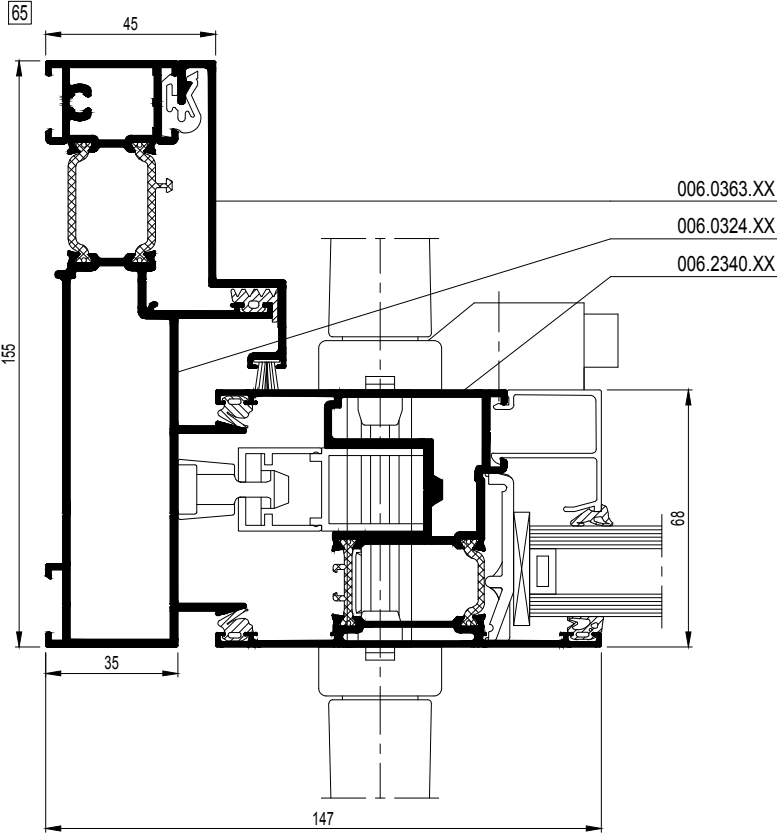
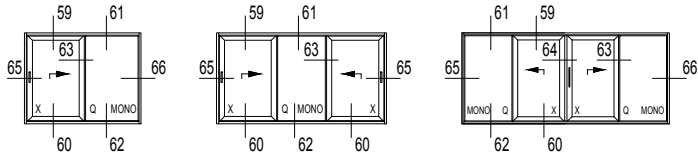

CP155LS-065001.dwg

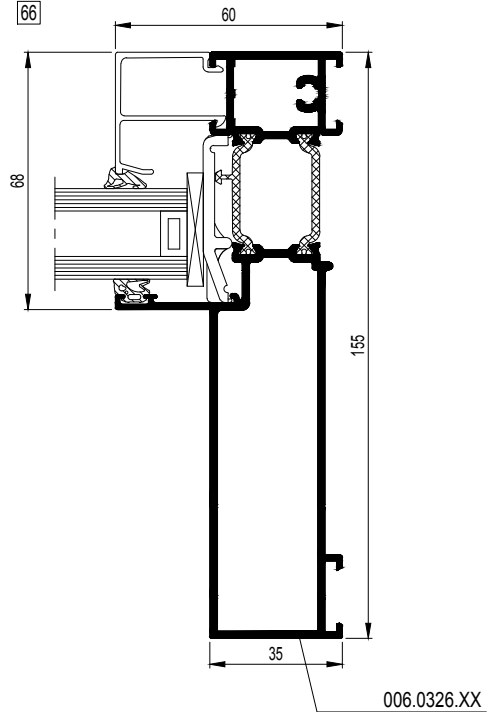

CP155LS-066001.dwg

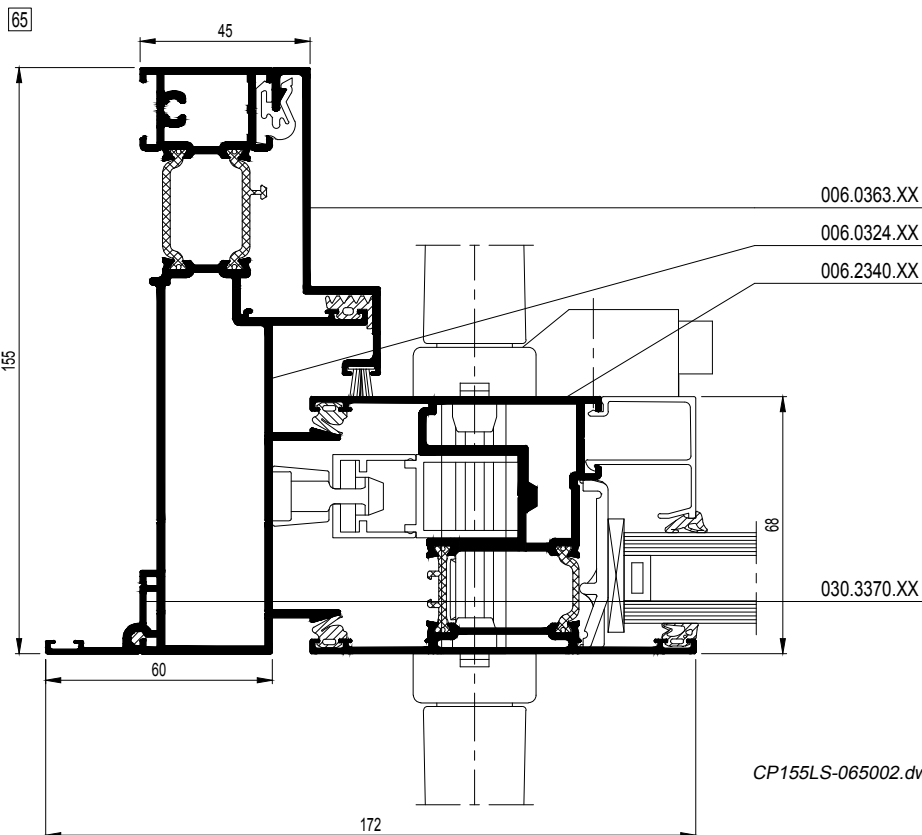

CP155LS-065002.dwg

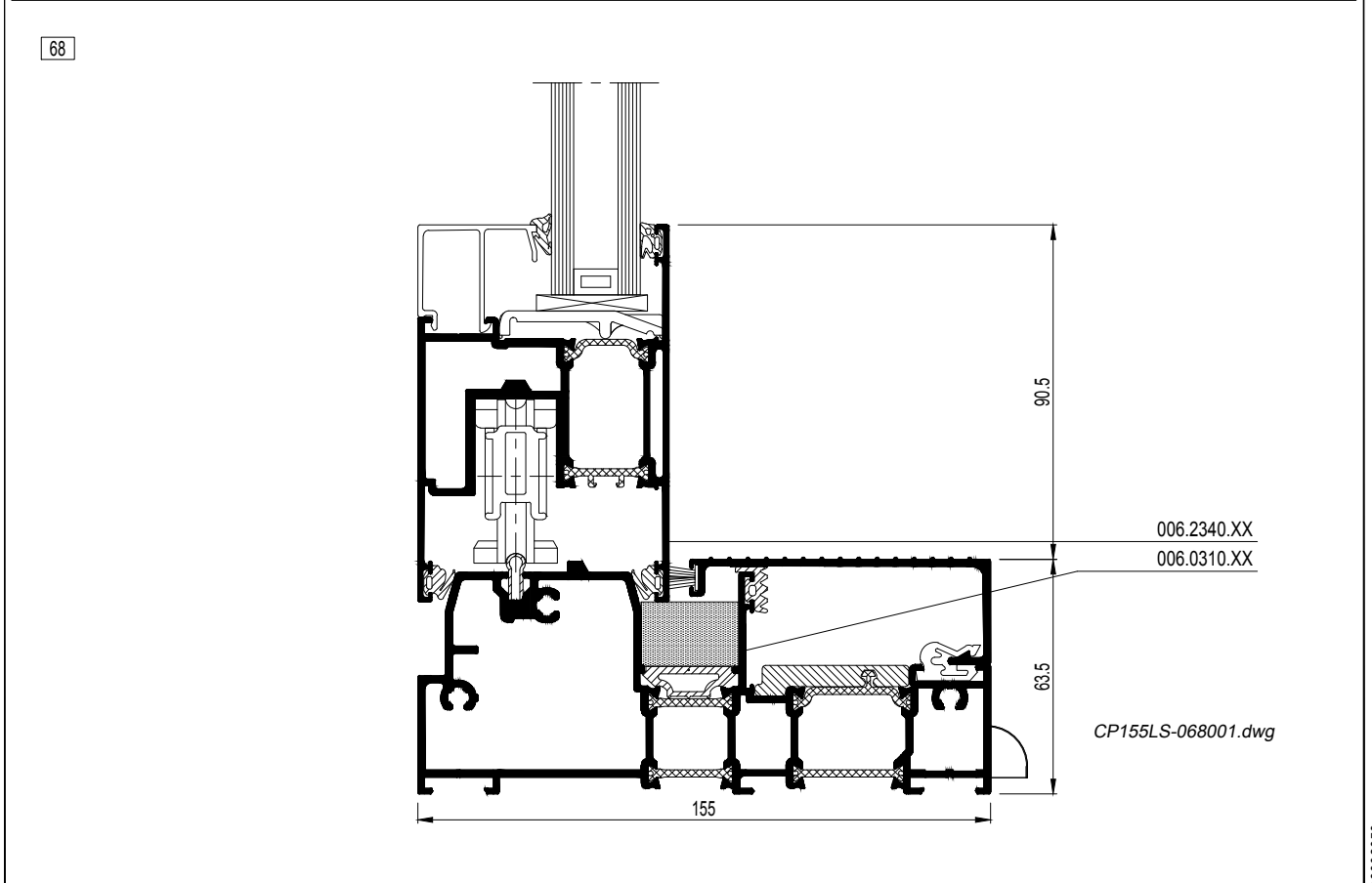
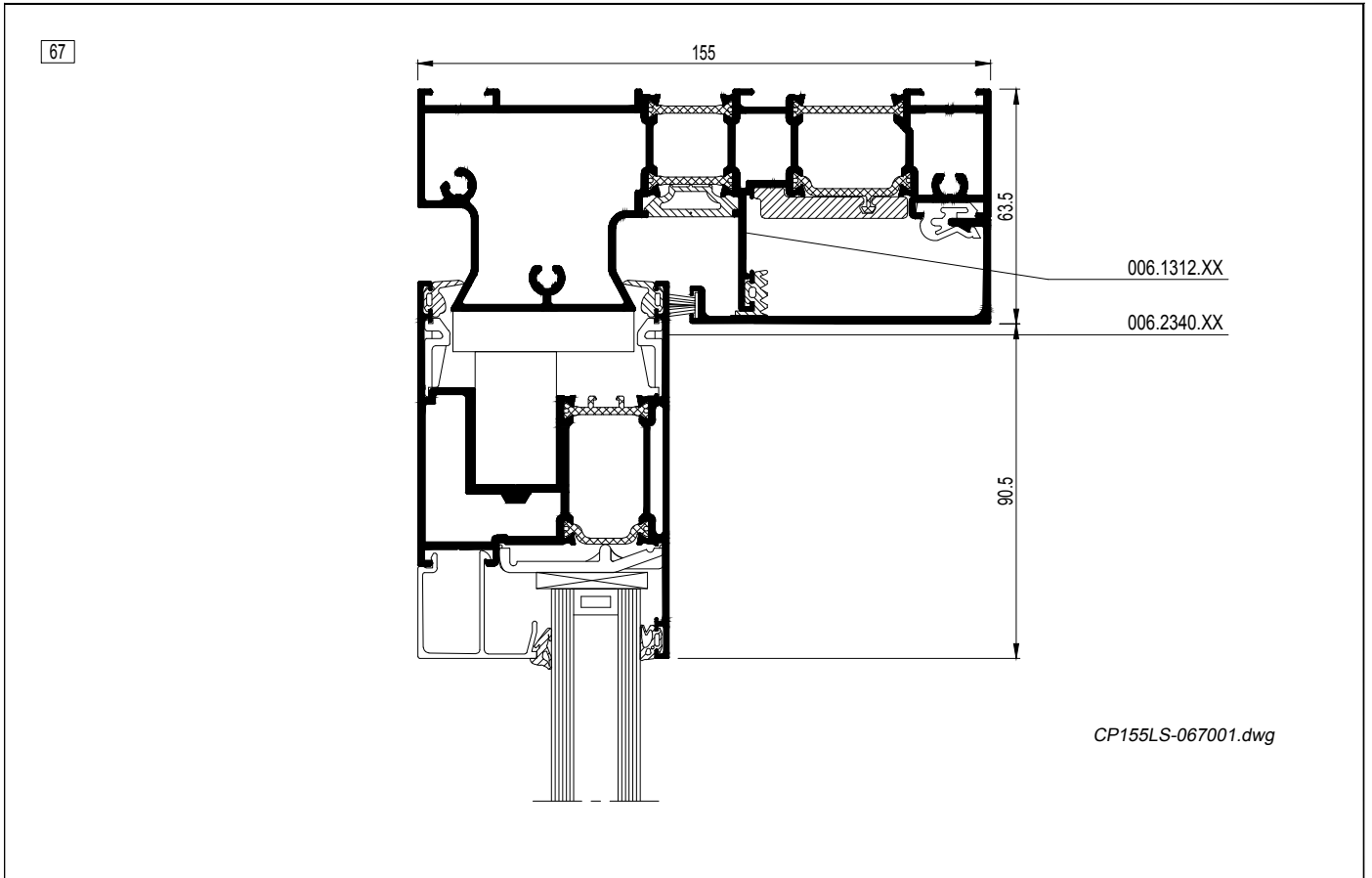
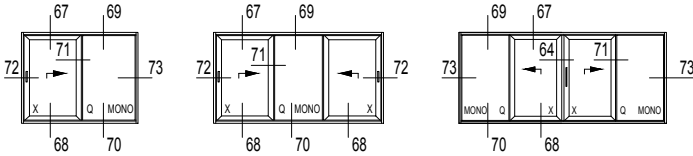

CP 155-LS

OPENGAANDE ELEMENTEN (MONORAIL) - BUITENBEGLAZING
ELEMENTS OUVRANTS (MONORAIL) - VITRAGE EXTERIEUR
OPENING ELEMENTS (MONORAIL) - OUTER GLAZING
OEFFNENDE ELEMENTE (MONORAIL) - AUSSENVERGLASUNG

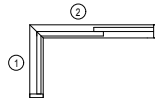
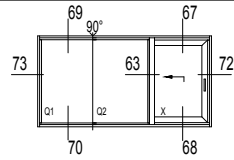
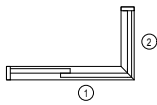
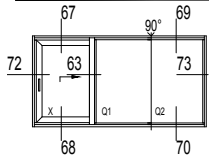

69

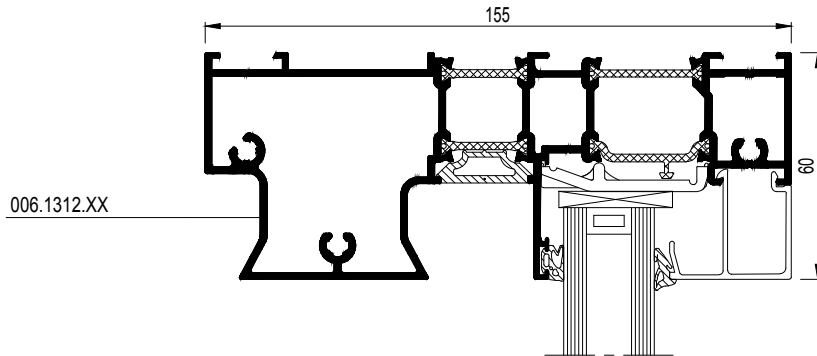

CP155LS-069001.dwg

70

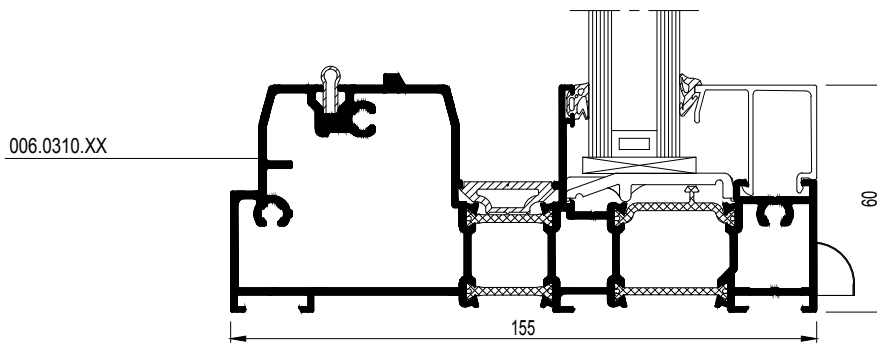

CP155LS-070001.dwg

CP 155-LS

OPENGAANDE ELEMENTEN (MONORAIL) - BUITENBEGLAZING
ELEMENTS OUVRANTS (MONORAIL) - VITRAGE EXTERIEUR
OPENING ELEMENTS (MONORAIL) - OUTER GLAZING
OEFFNENDE ELEMENTE (MONORAIL) - AUSSENVERGLASUNG

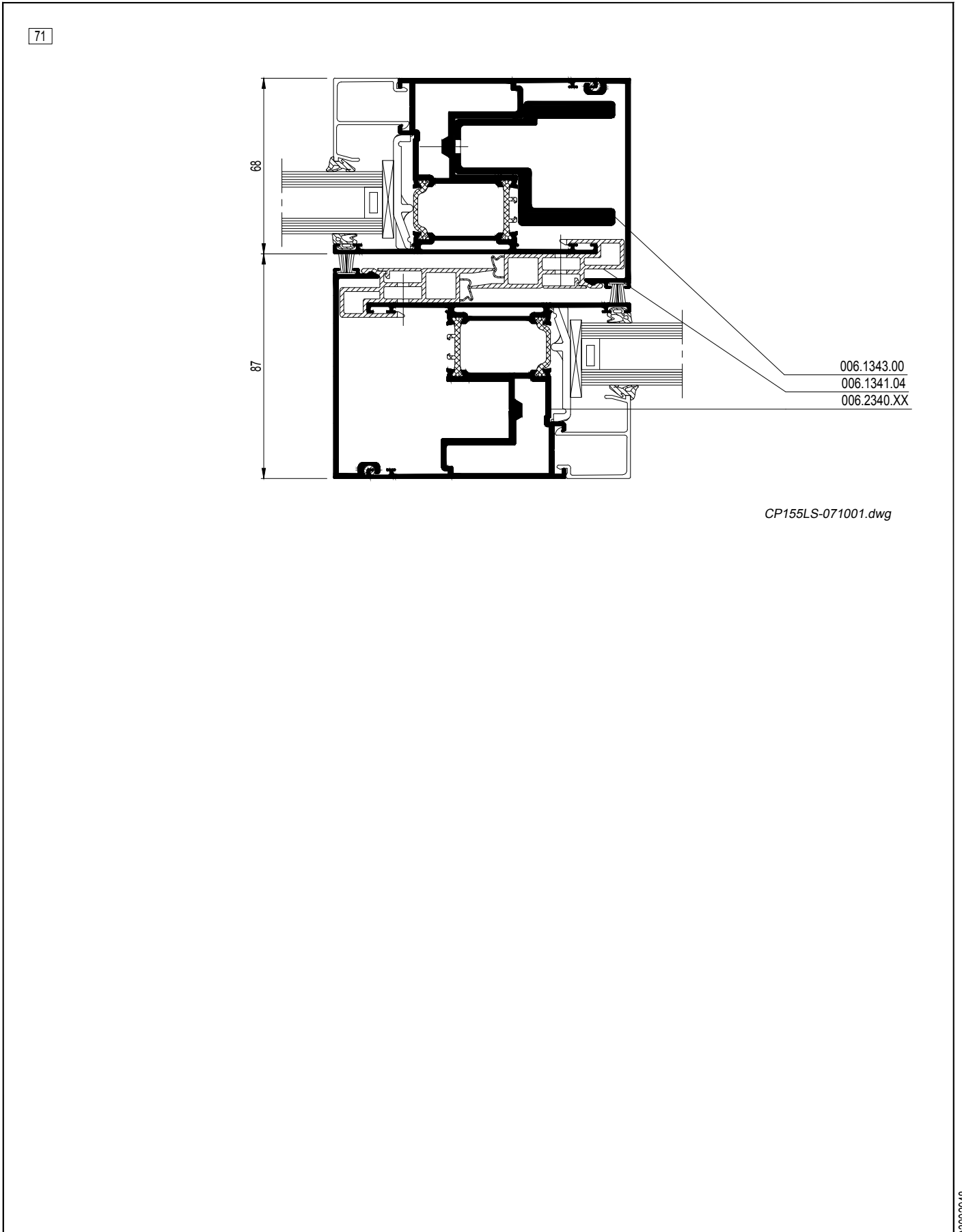
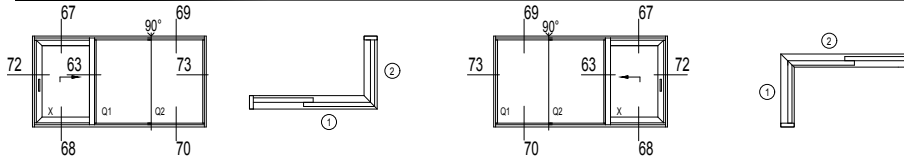

CP155LS-071001.dwg

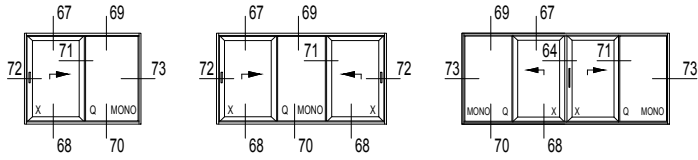

72

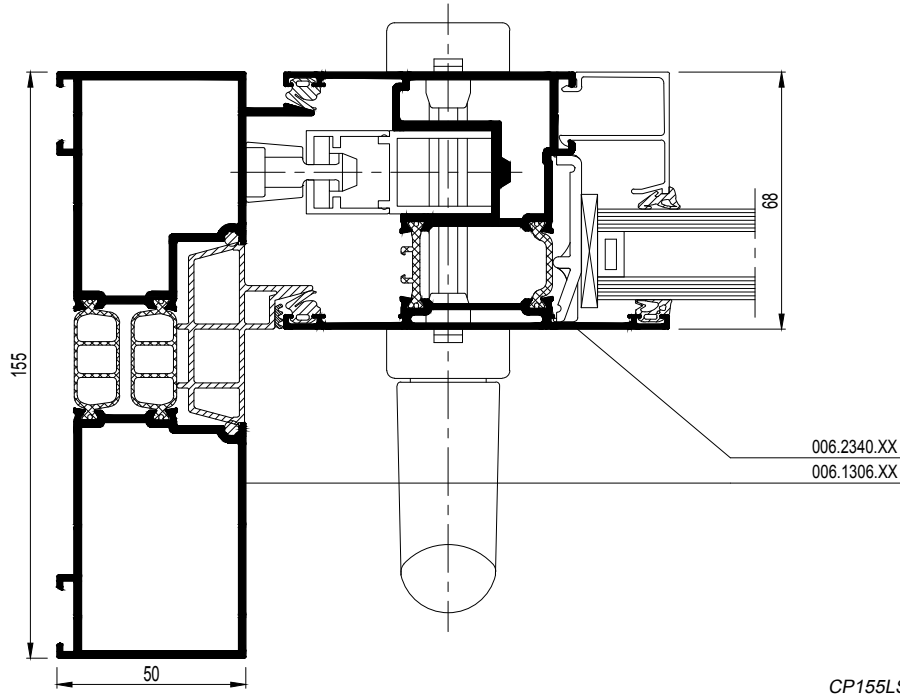

CP155LS-072001.dwg

73

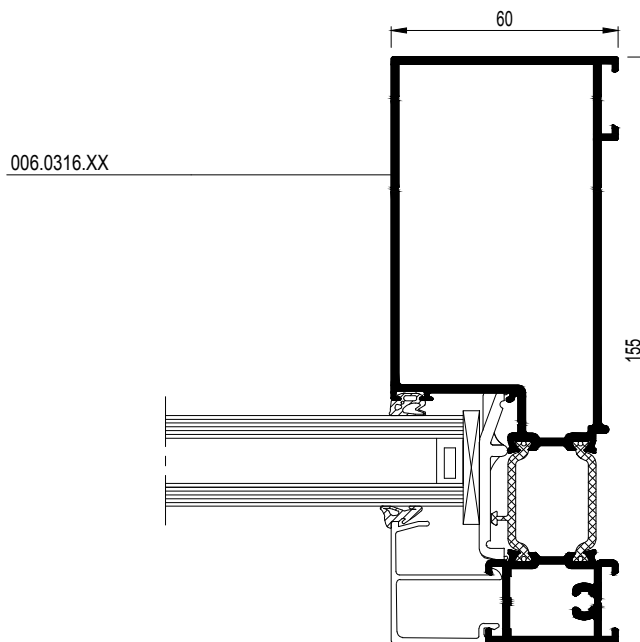

CP155LS-073001.dwg

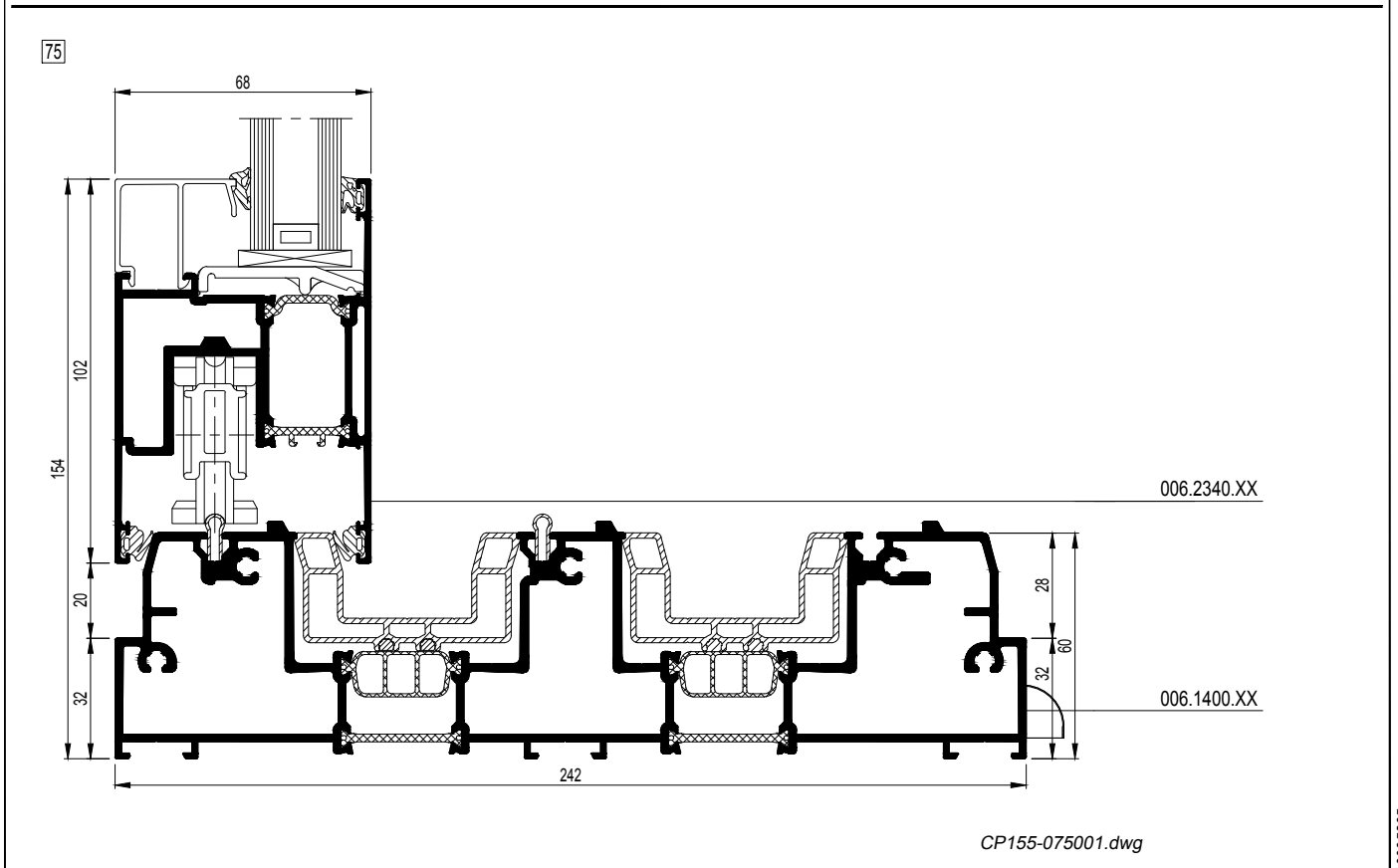
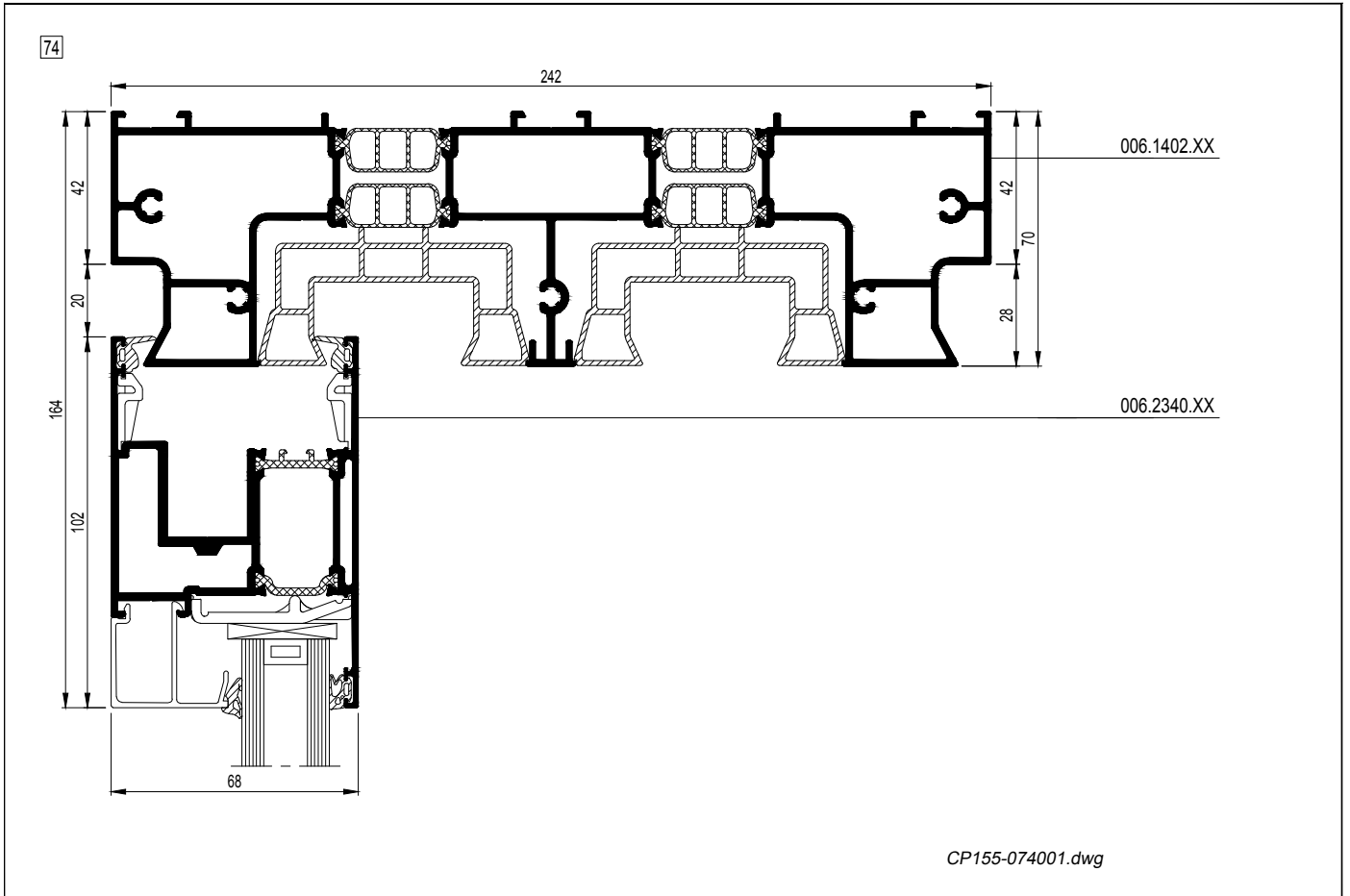
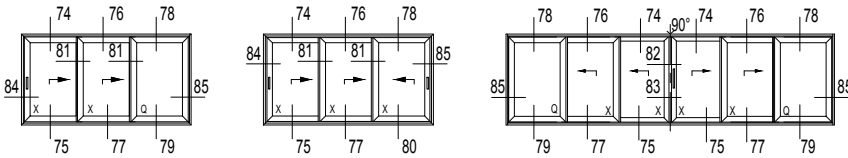

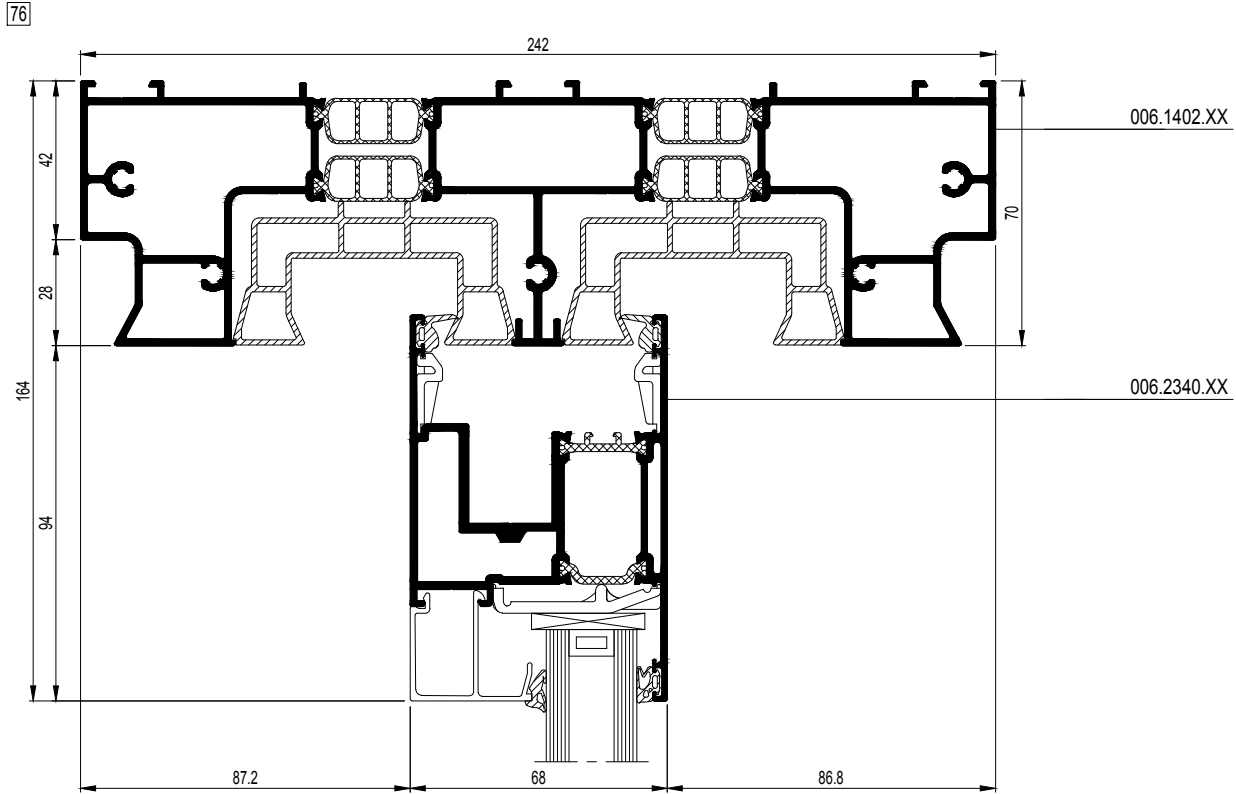
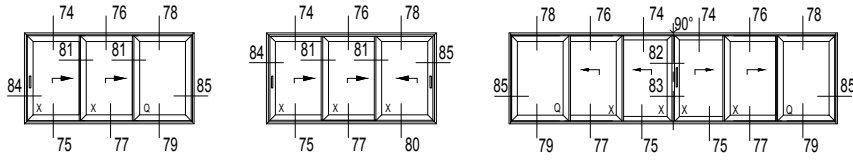

CP155-076001.dwg

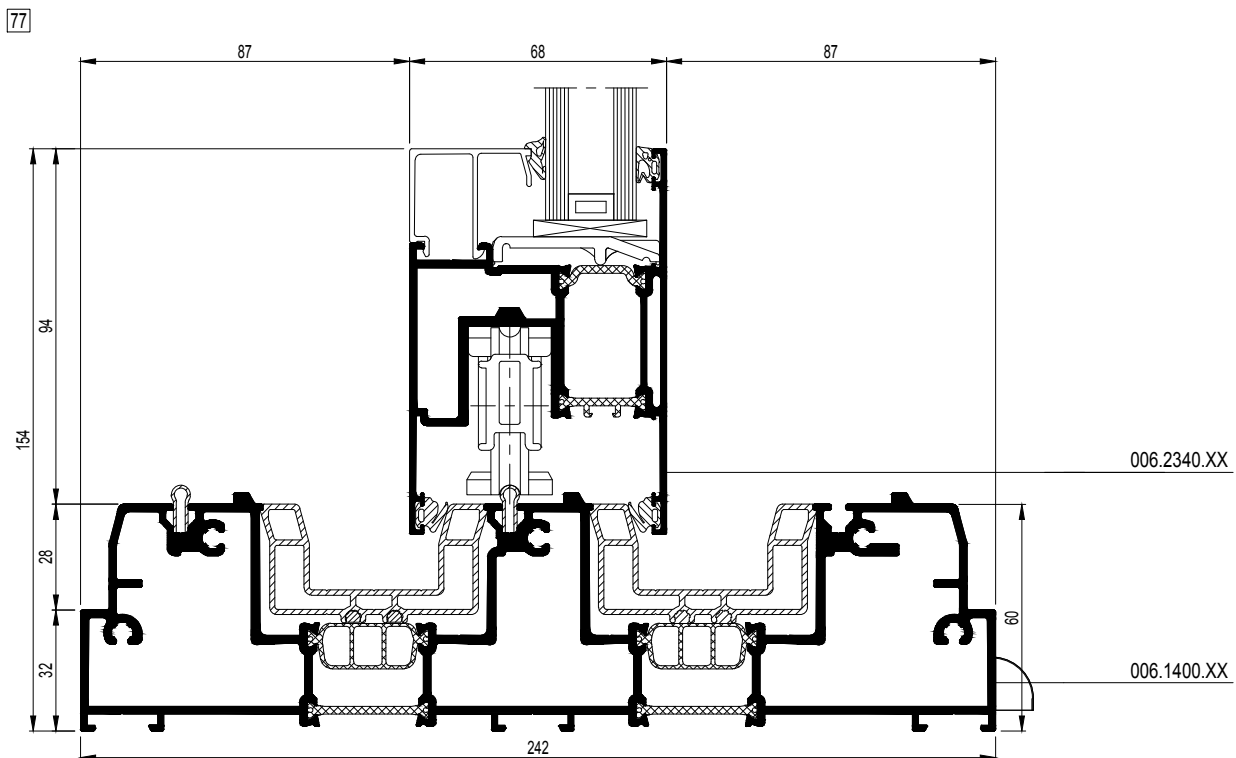

CP155-077001.dwg

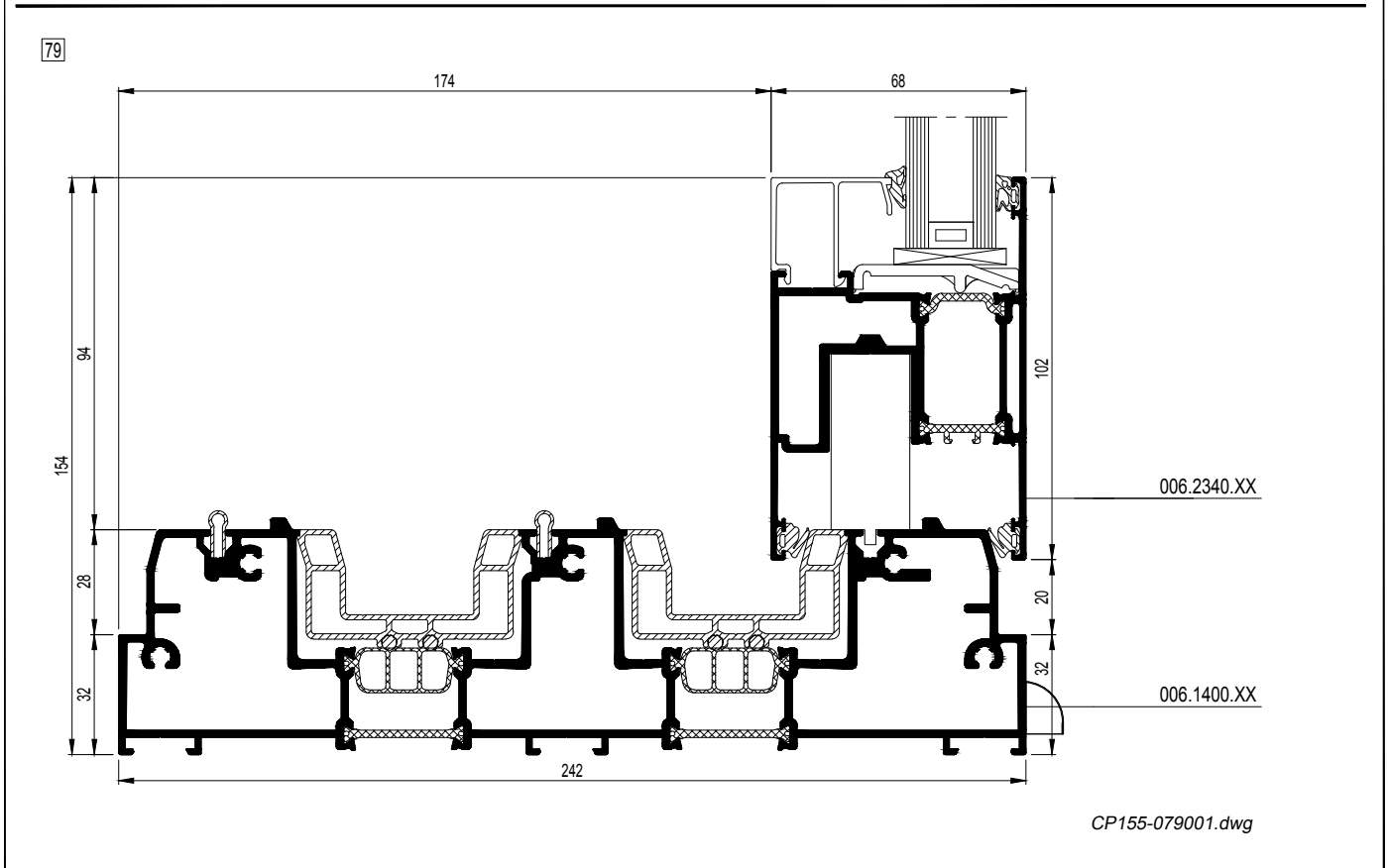
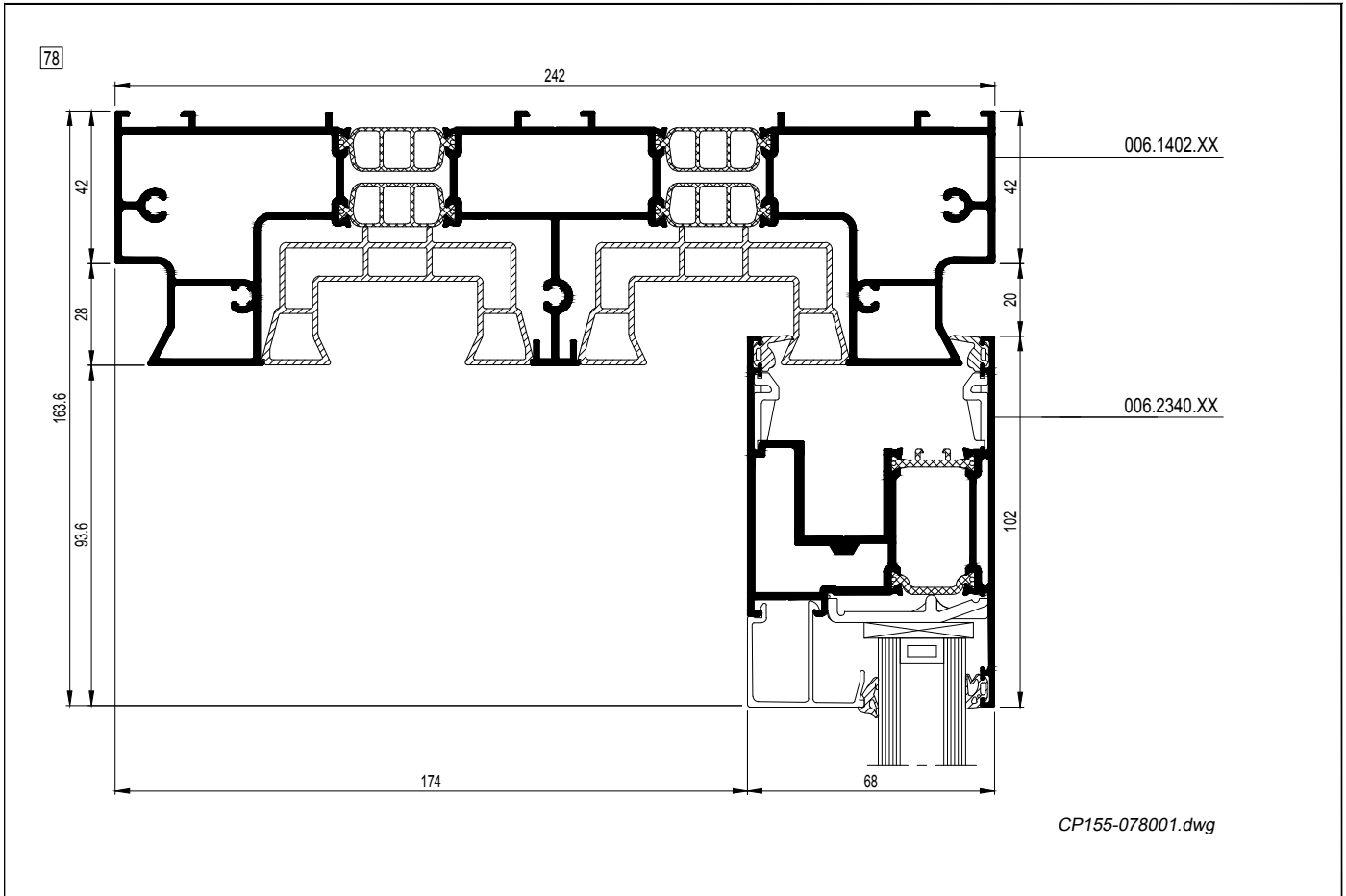
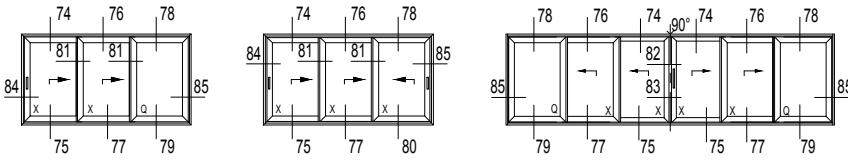

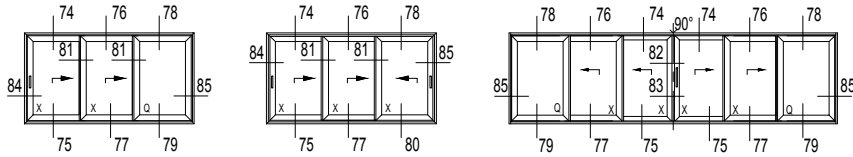

80

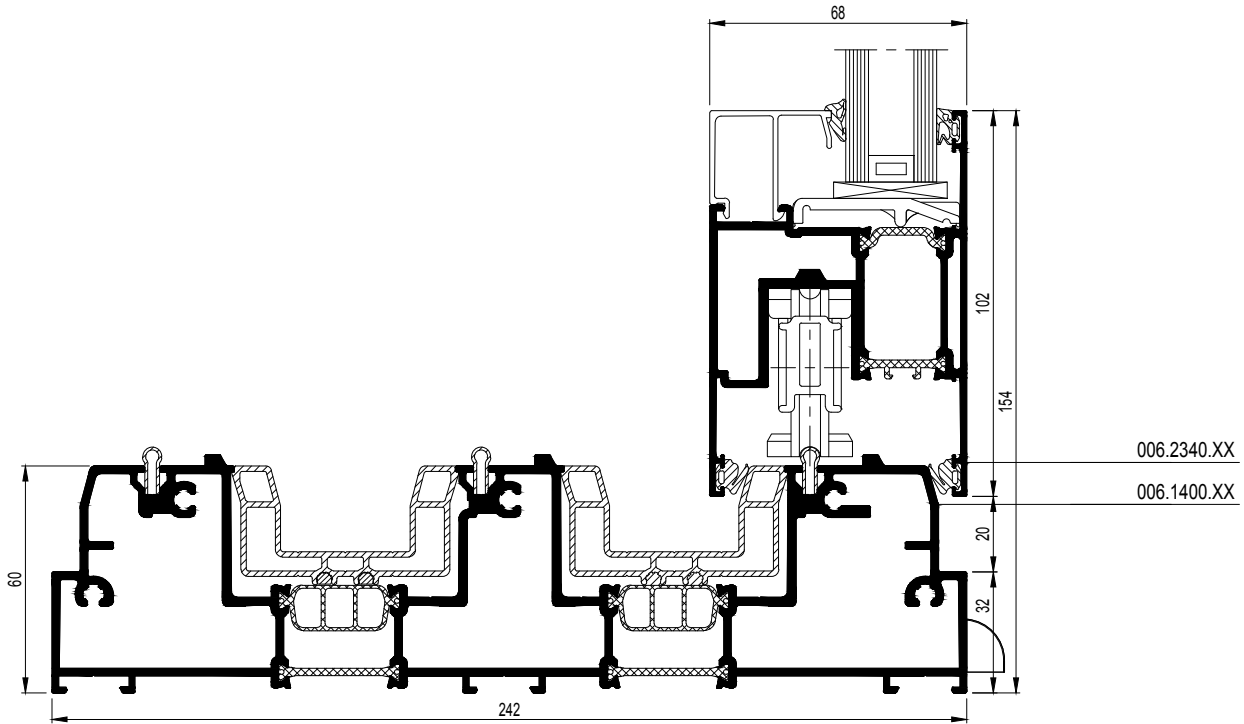

CP155-080001.dwg

81

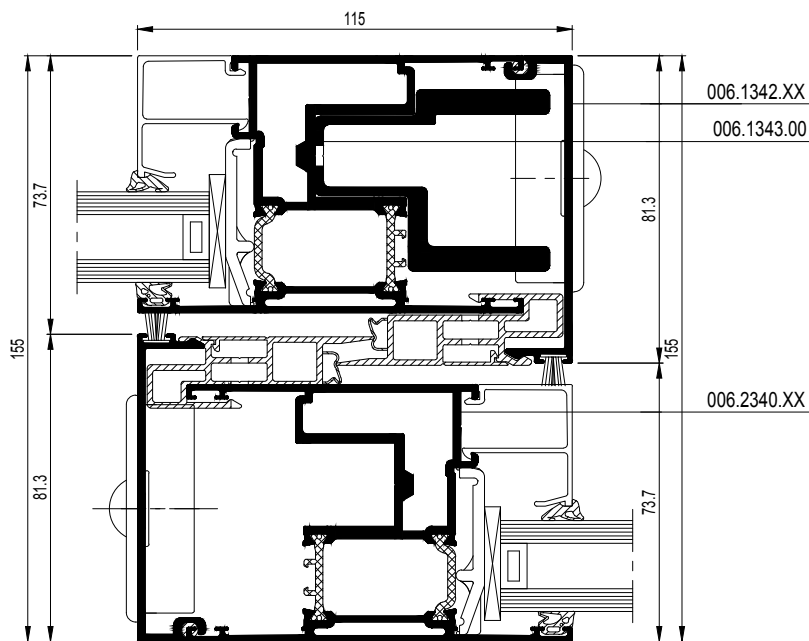

CP155-081001.dwg

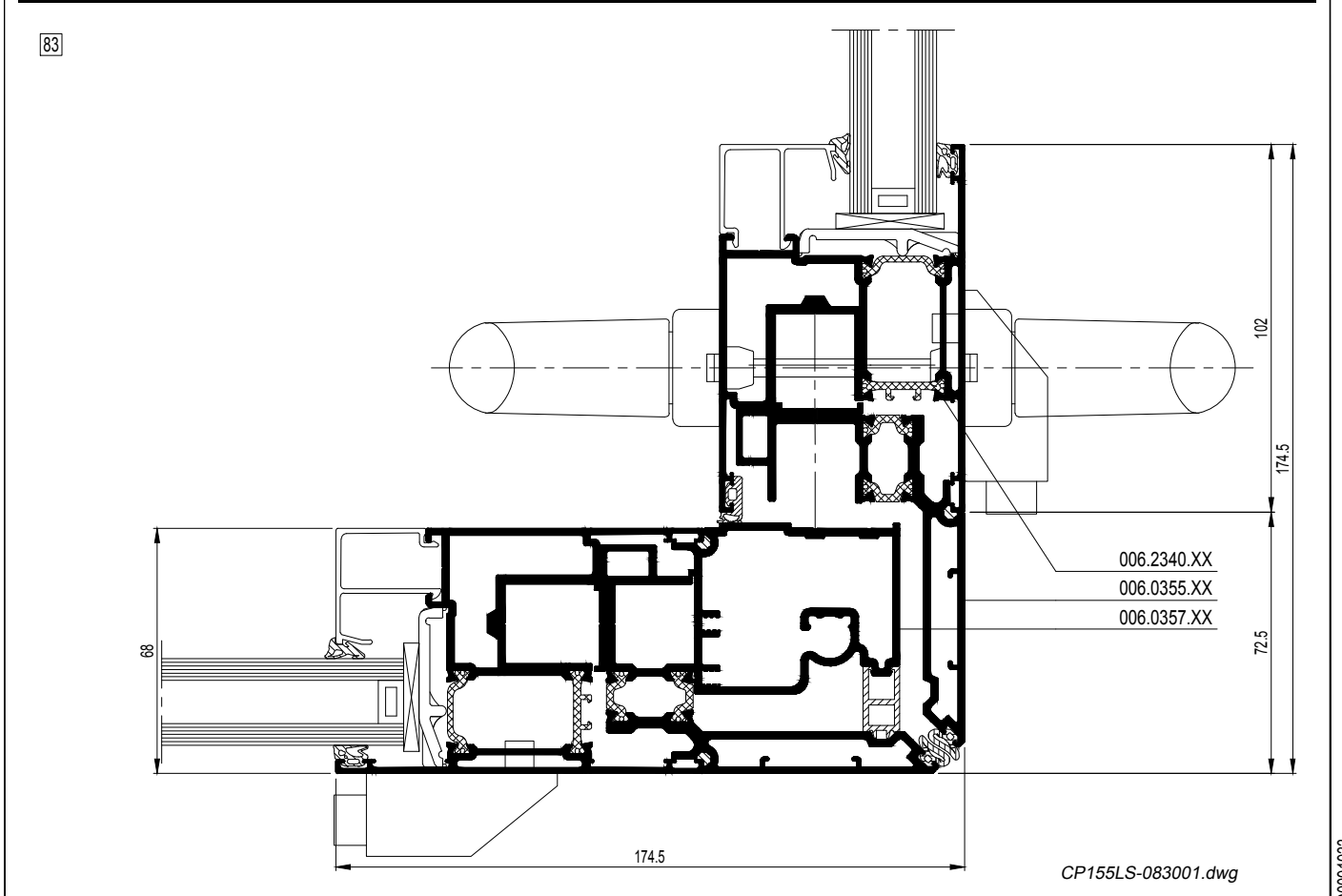
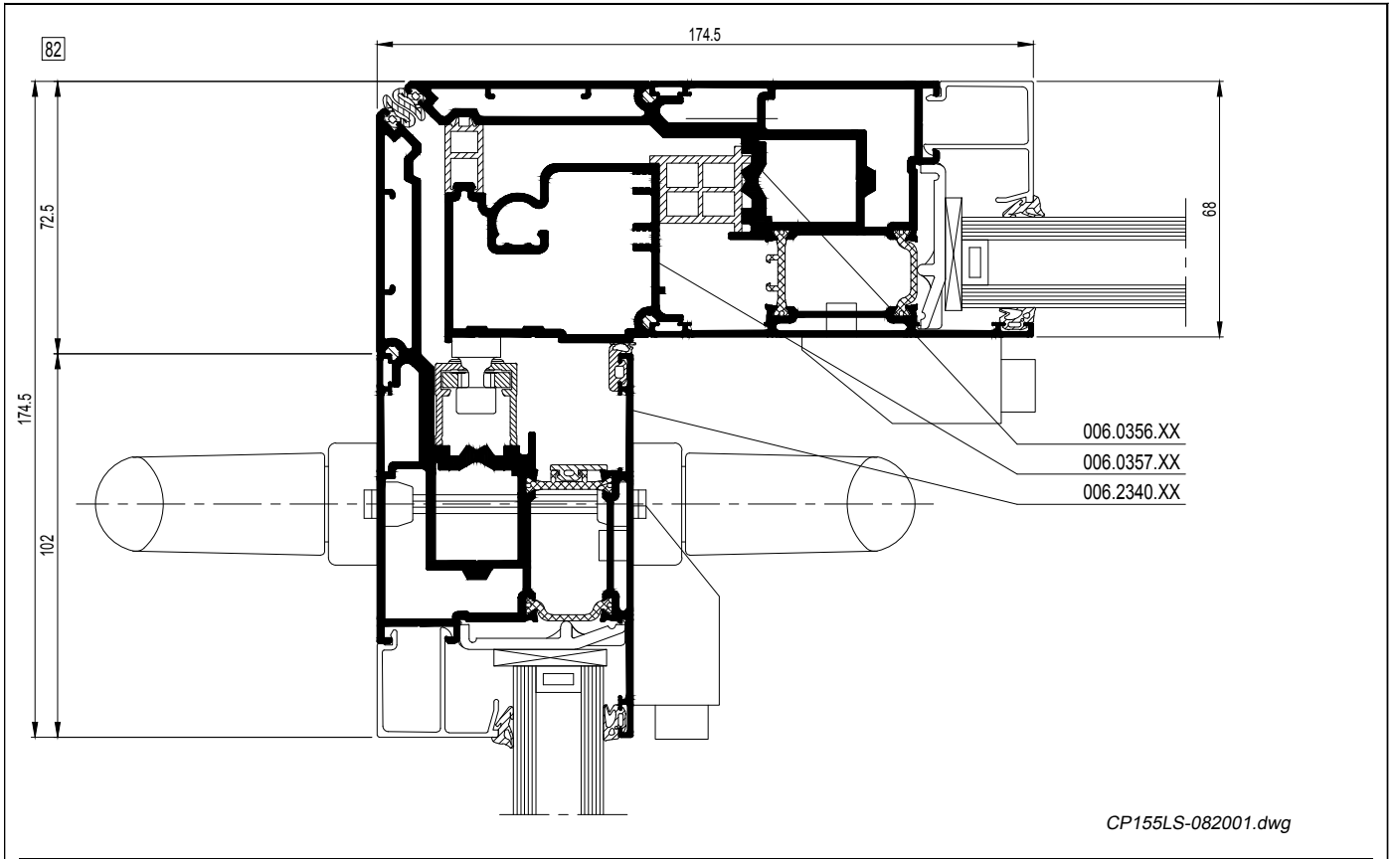
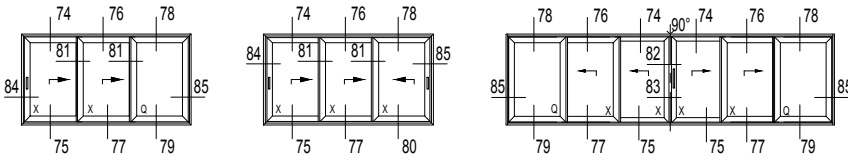

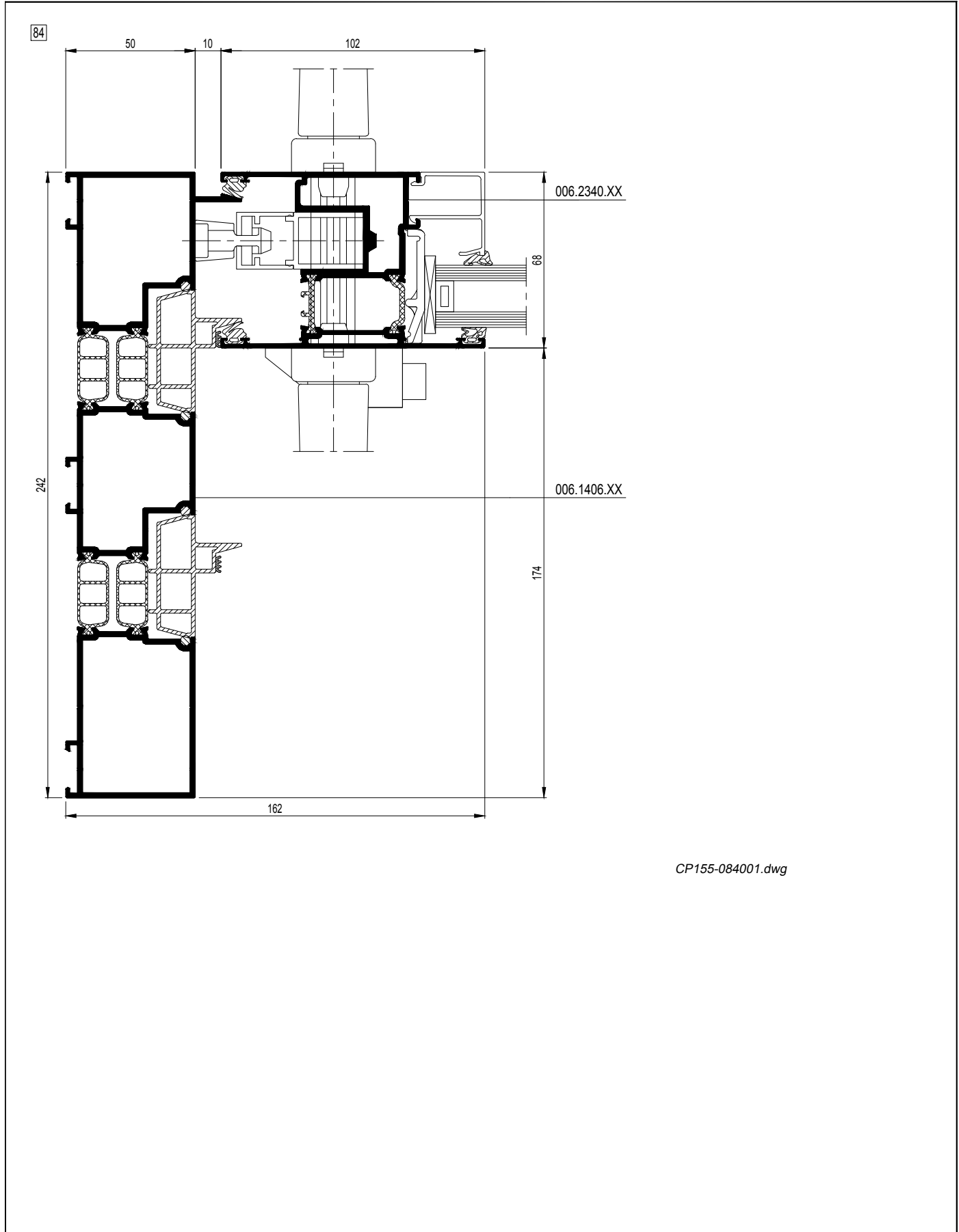
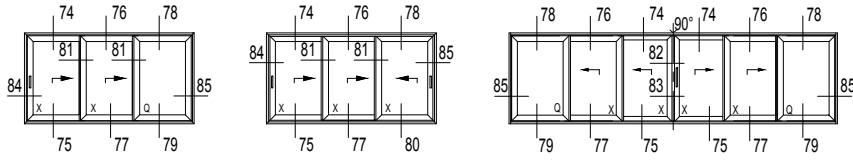

CP155-084001.dwg

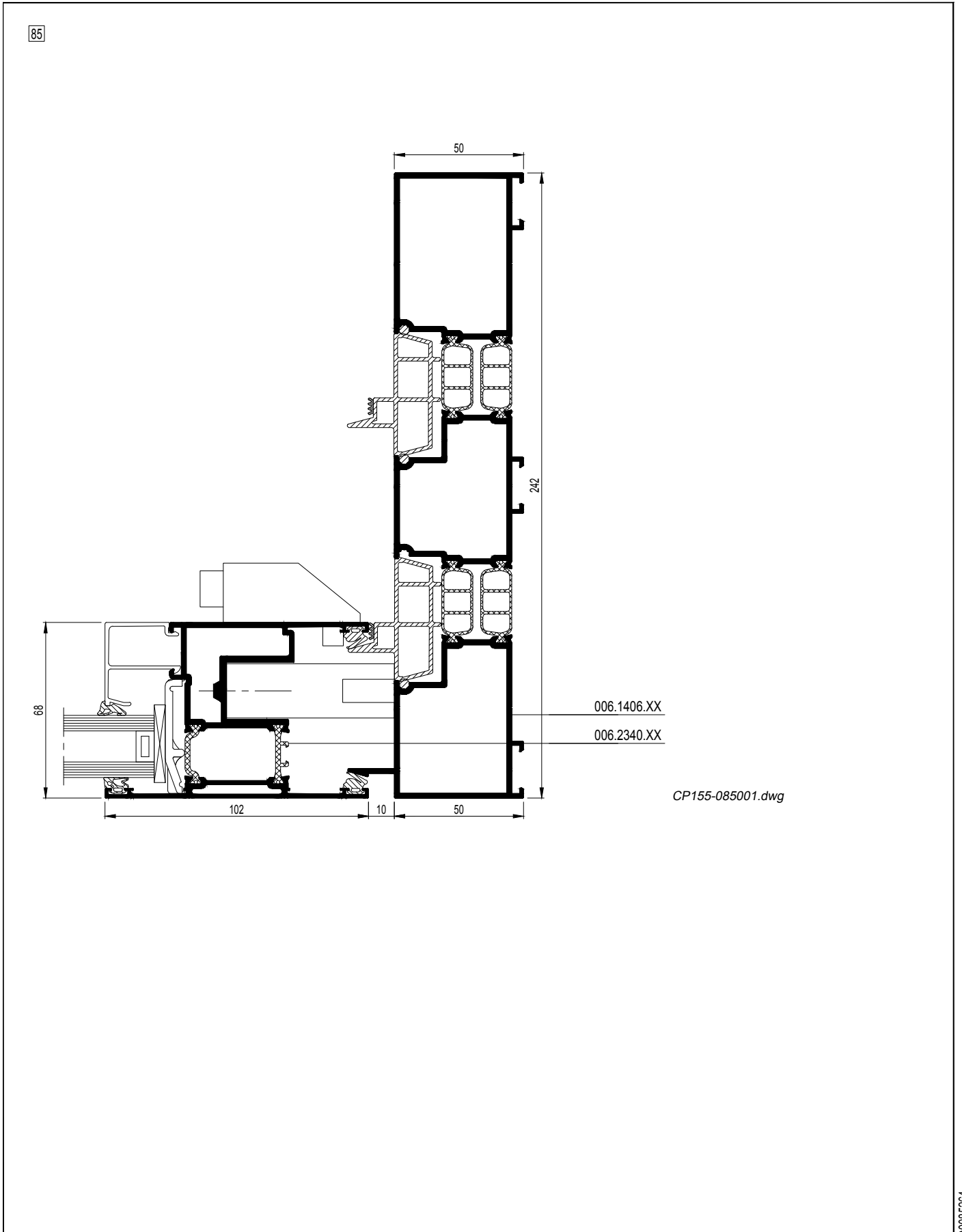
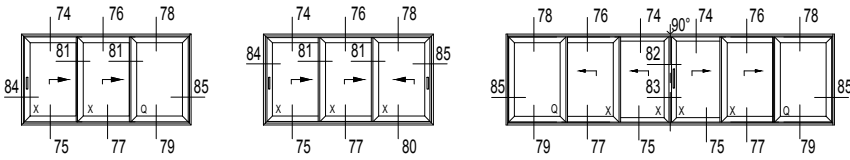

CP155-085001.dwg

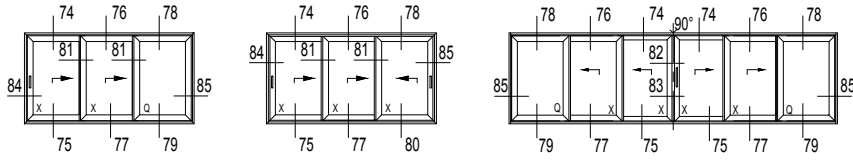

86

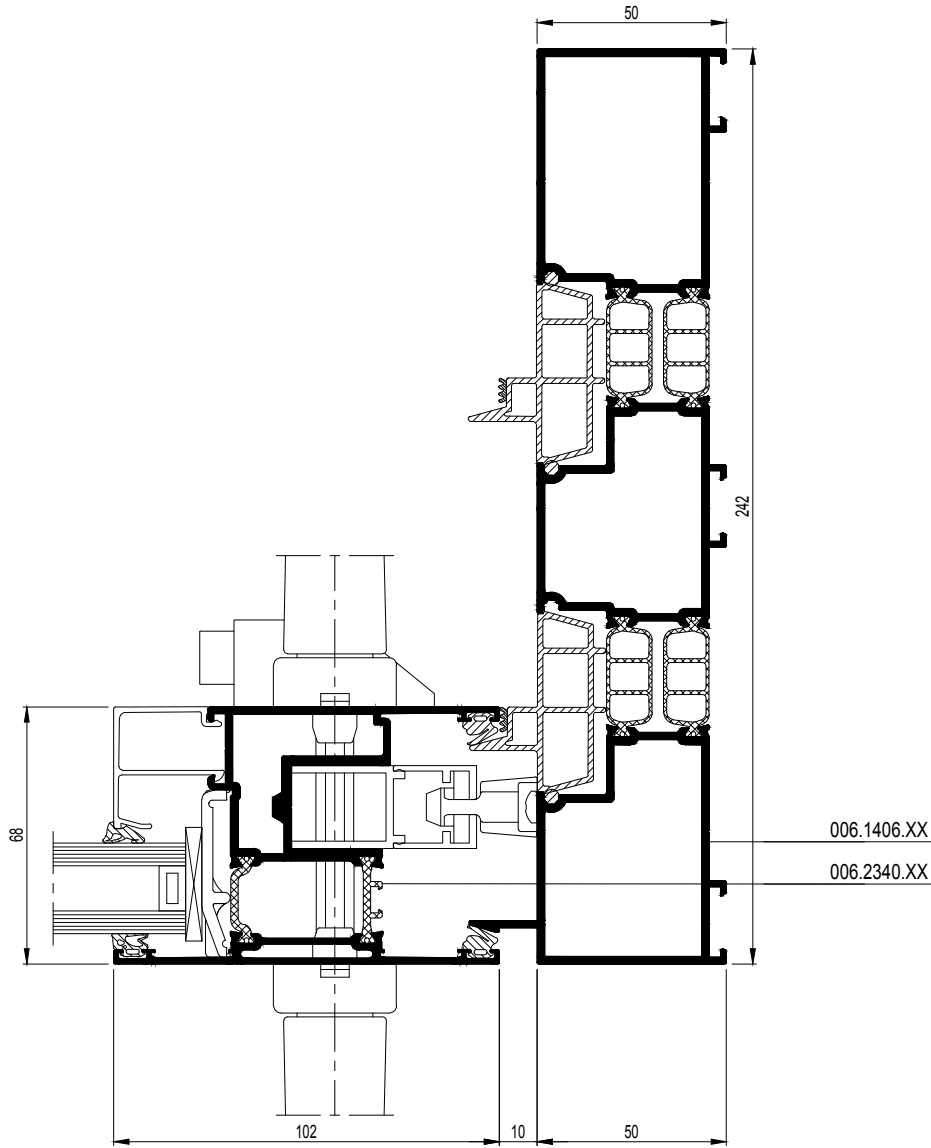

CP155-086001.dwg

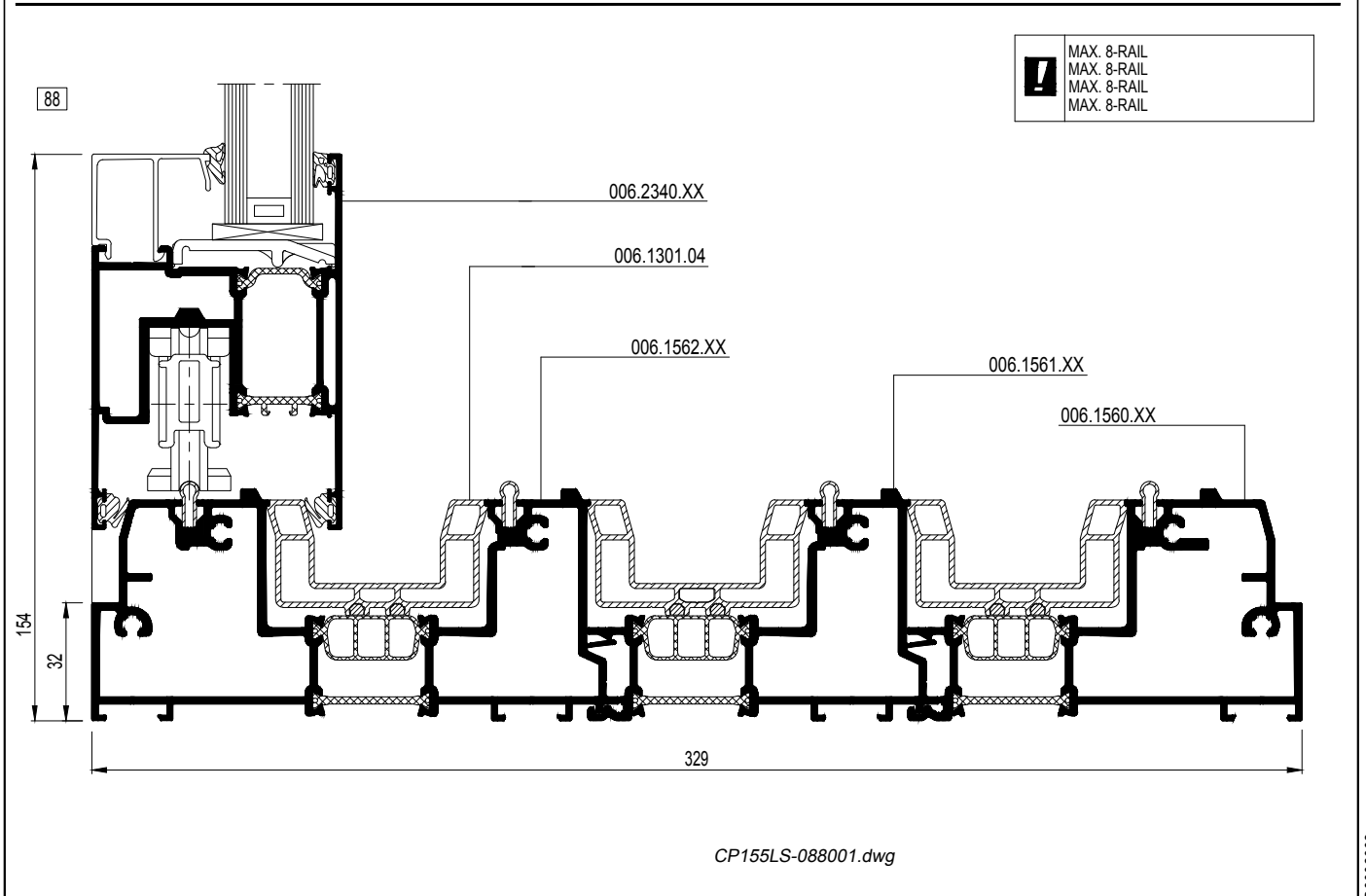
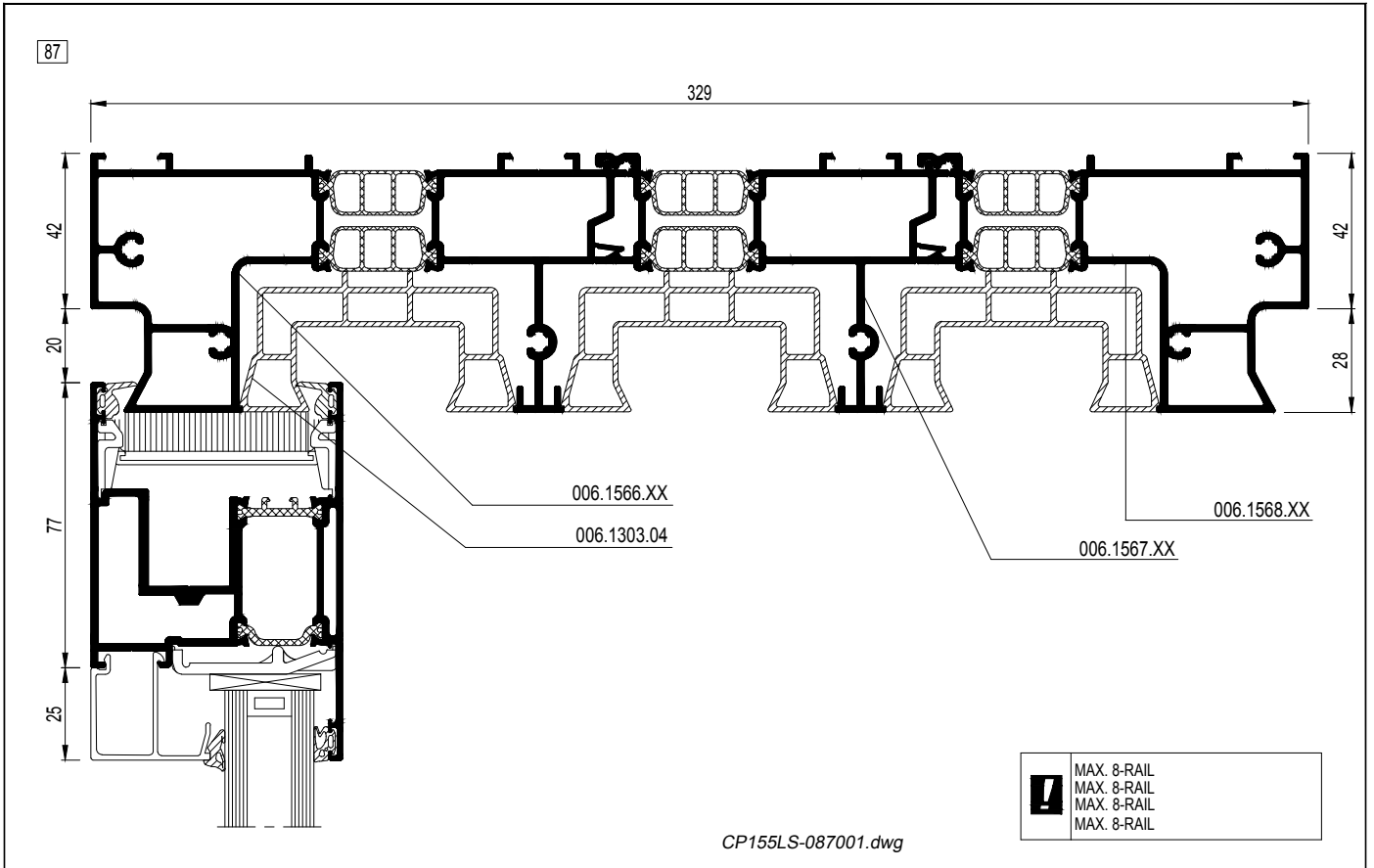
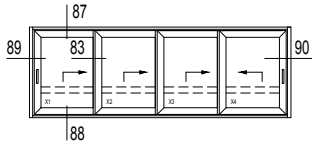

CP 155-LS

OPENGAANDE ELEMENTEN (MULTI-RAIL) - BUITENKADERS
ELEMENTS OUVRANTS (MULTI-RAIL) - DORMANTS
OPENING ELEMENTS (MULTI-RAIL) - OUTER FRAMES
OEFFNENDE ELEMENTE (MULTI-RAIL) - BLENDRAHMEN

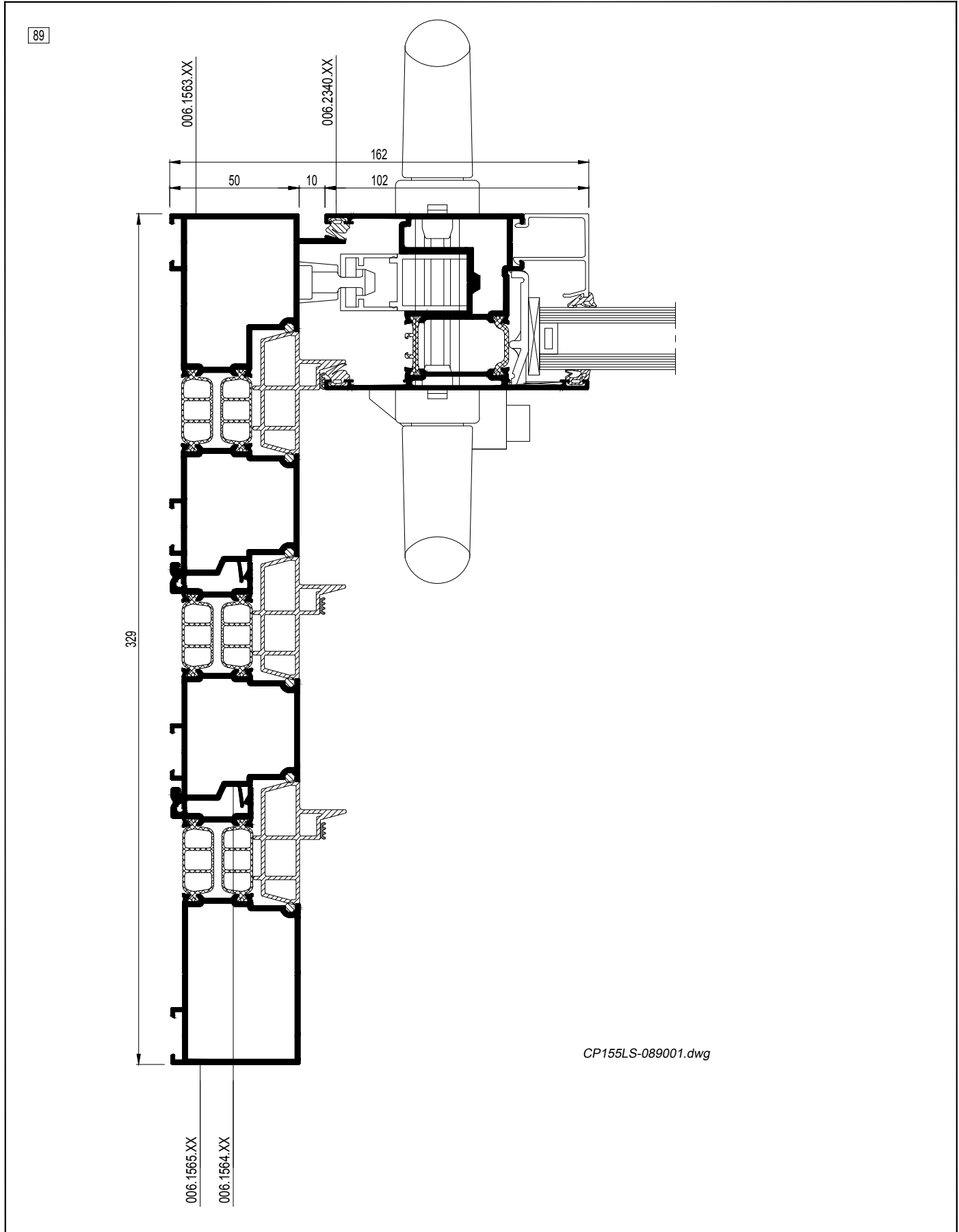
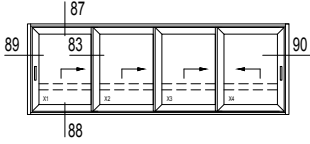

CP155LS-089001.dwg

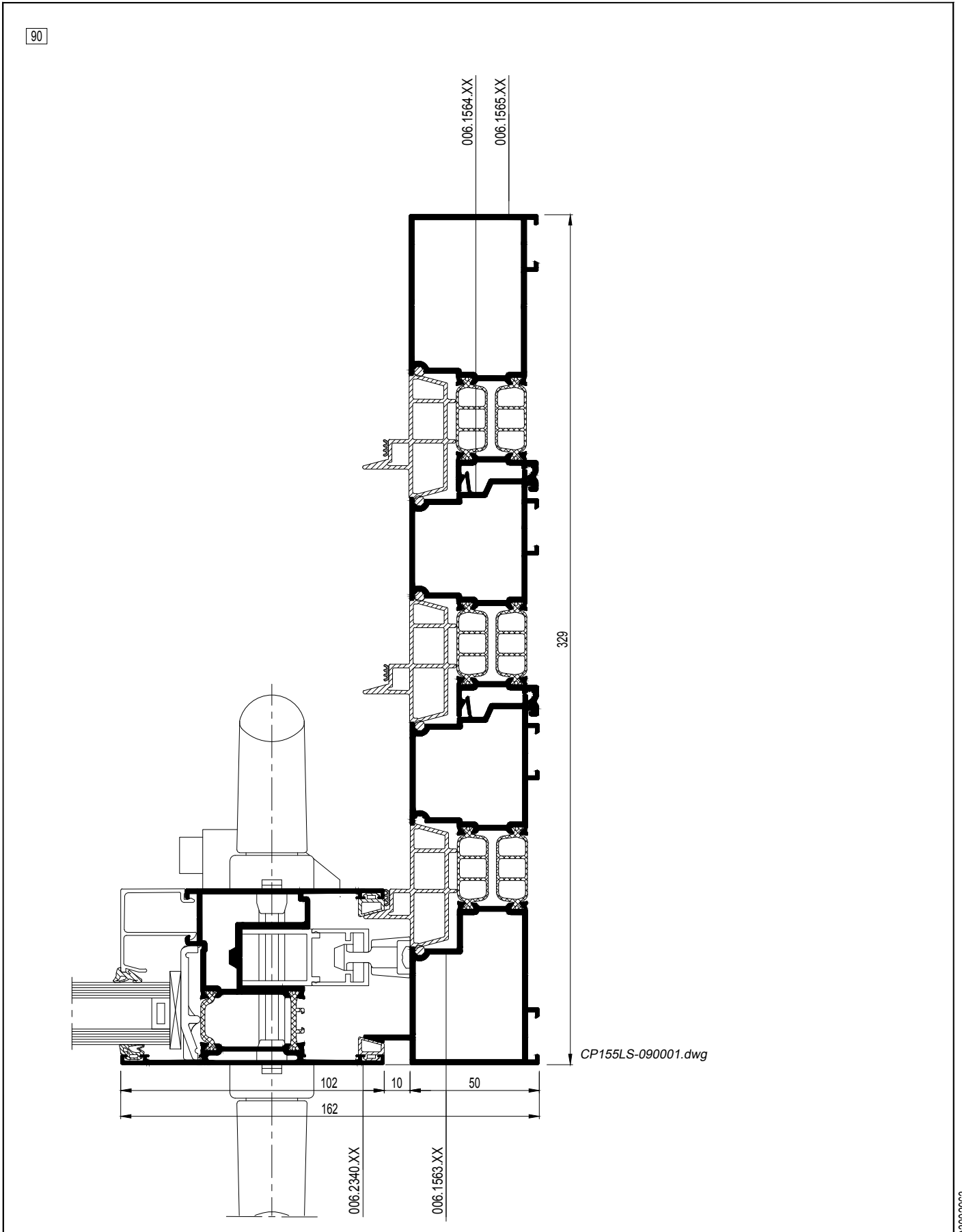
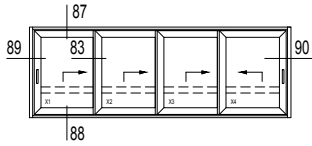

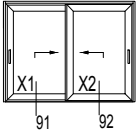

91

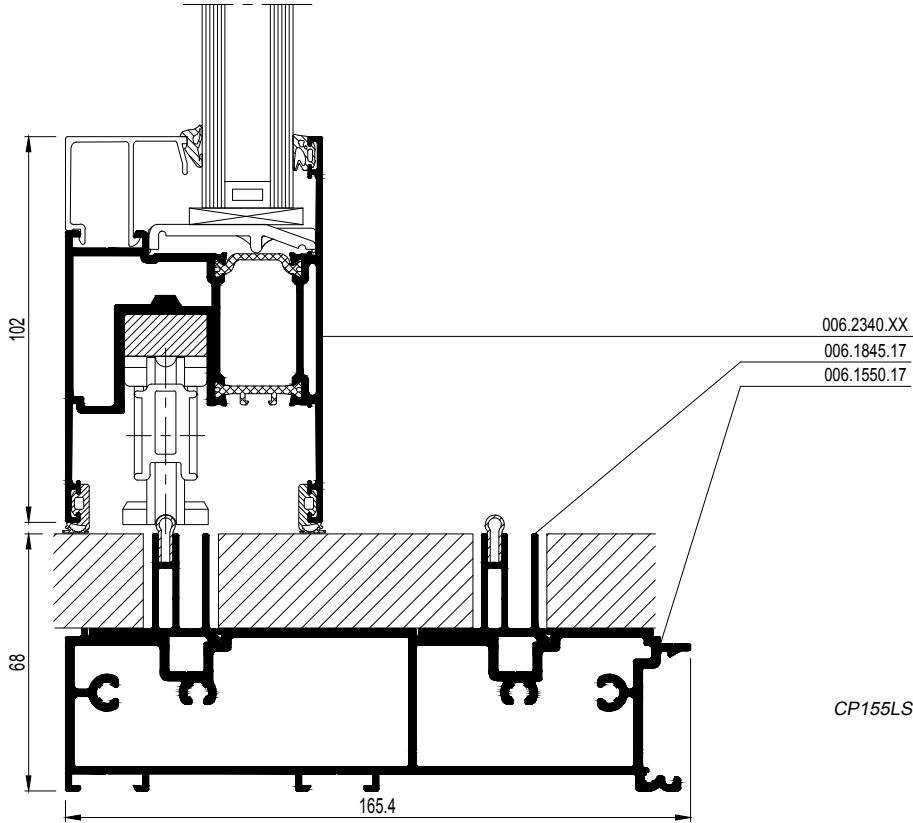

CP155LS-091001.dwg

92

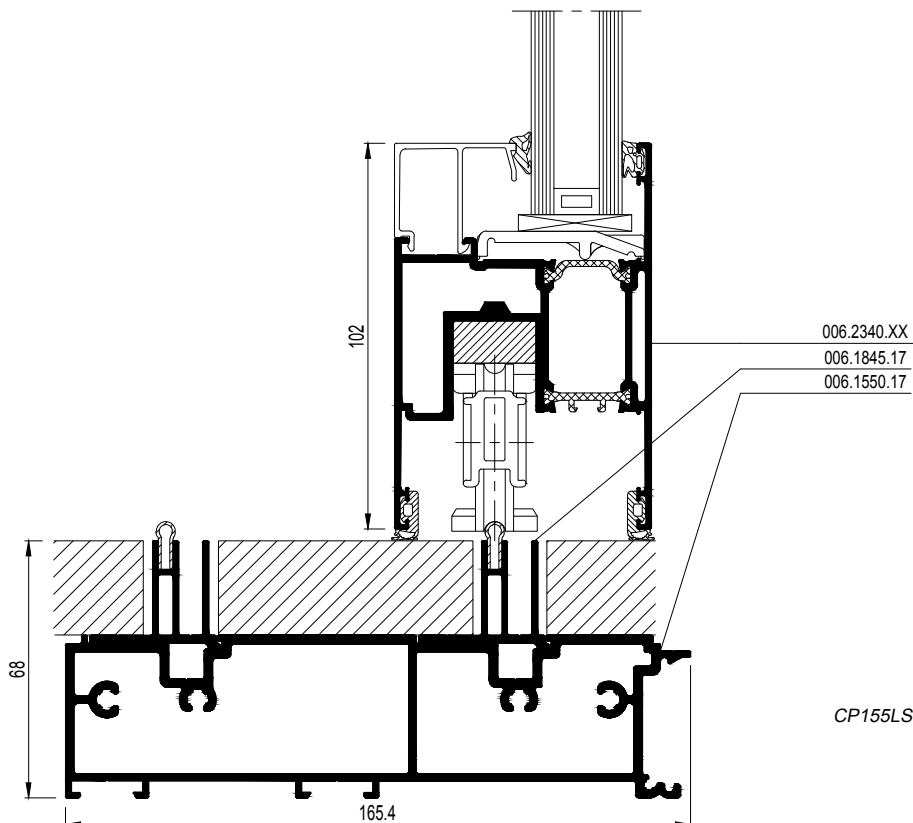

CP155LS-092001.dwg

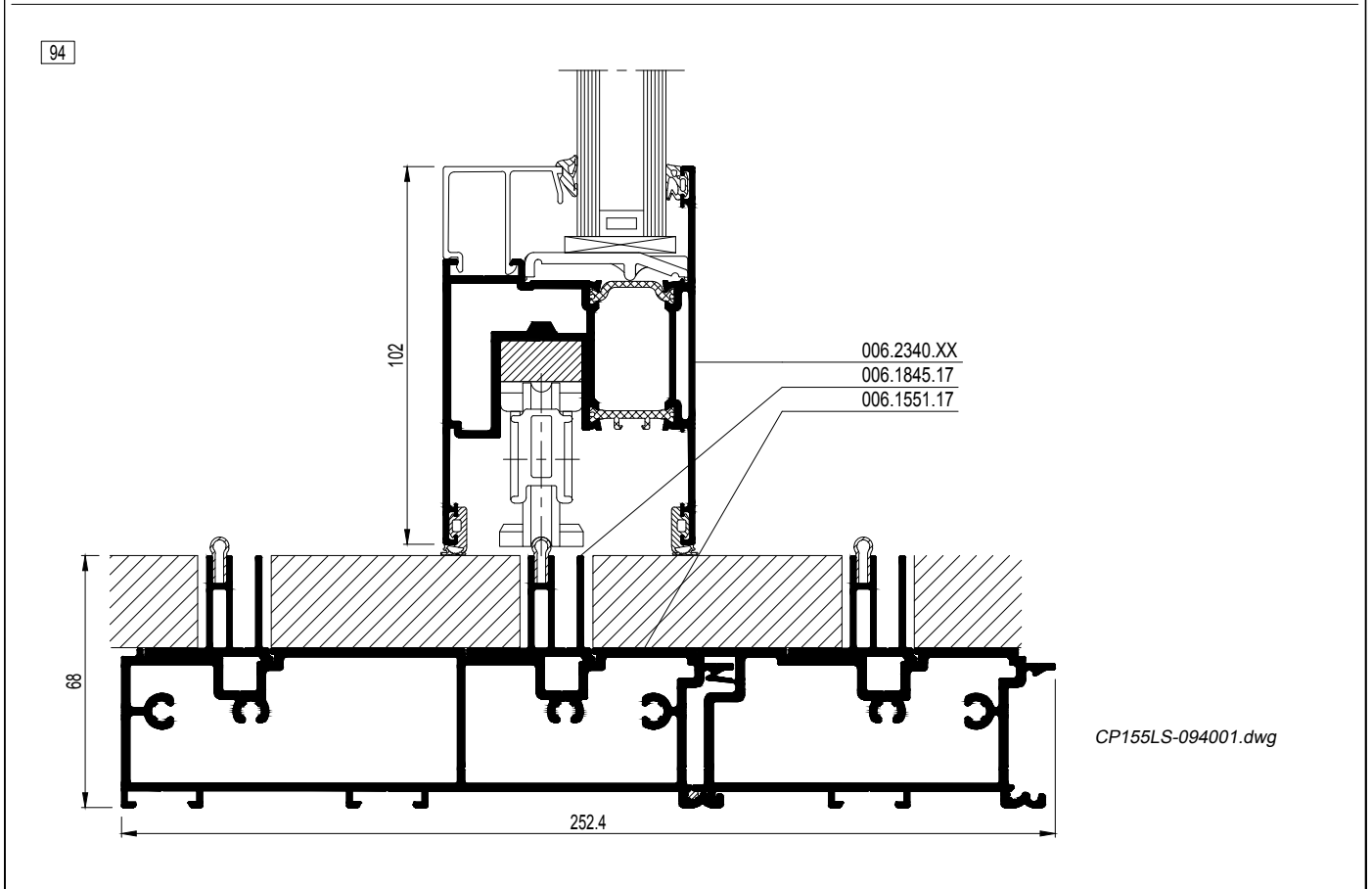
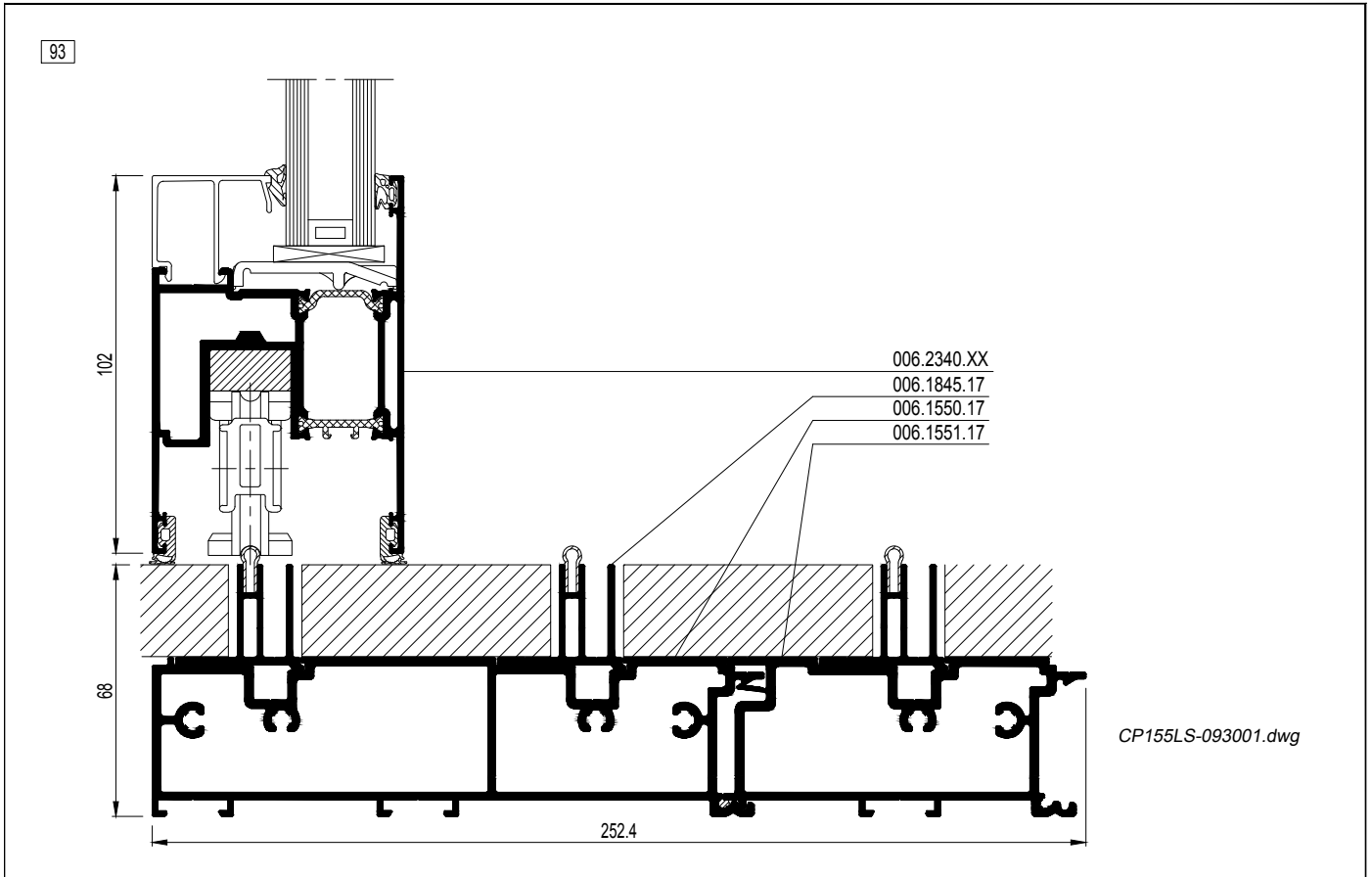
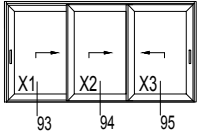

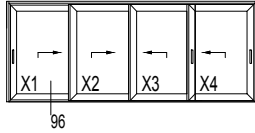
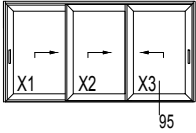

95

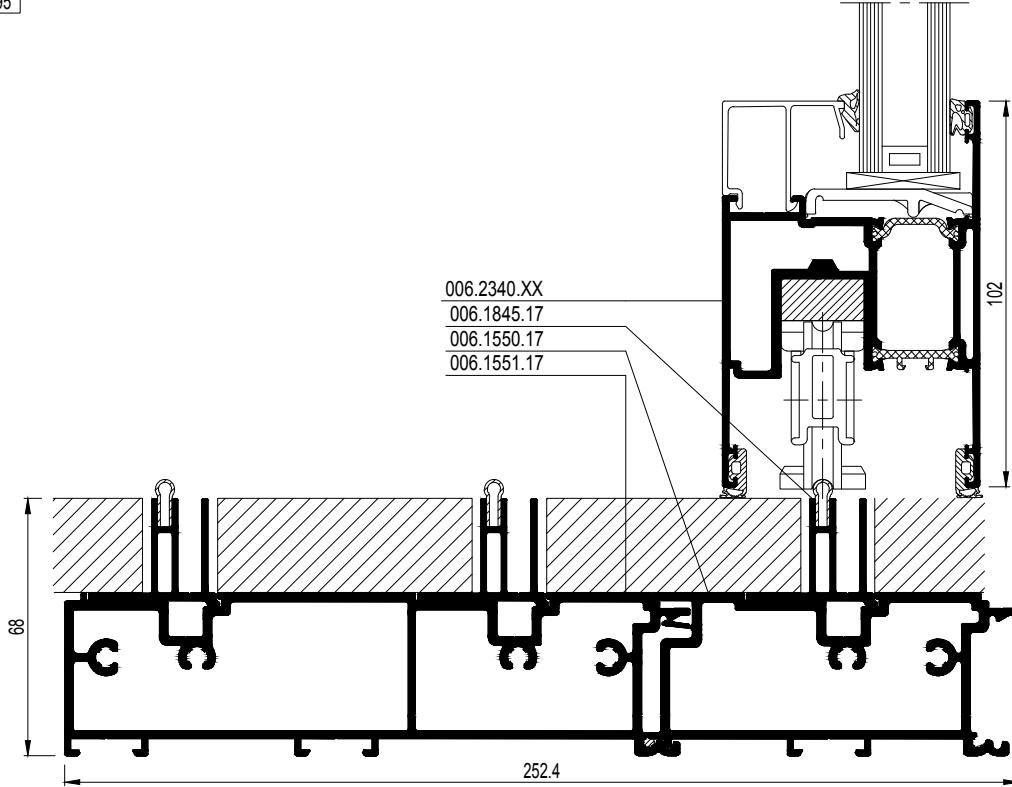

CP155LS-095001.dwg

96

| | |
|--|-------------|
| | MAX. 8-RAIL |
| | MAX. 8-RAIL |
| | MAX. 8-RAIL |
| | MAX. 8-RAIL |

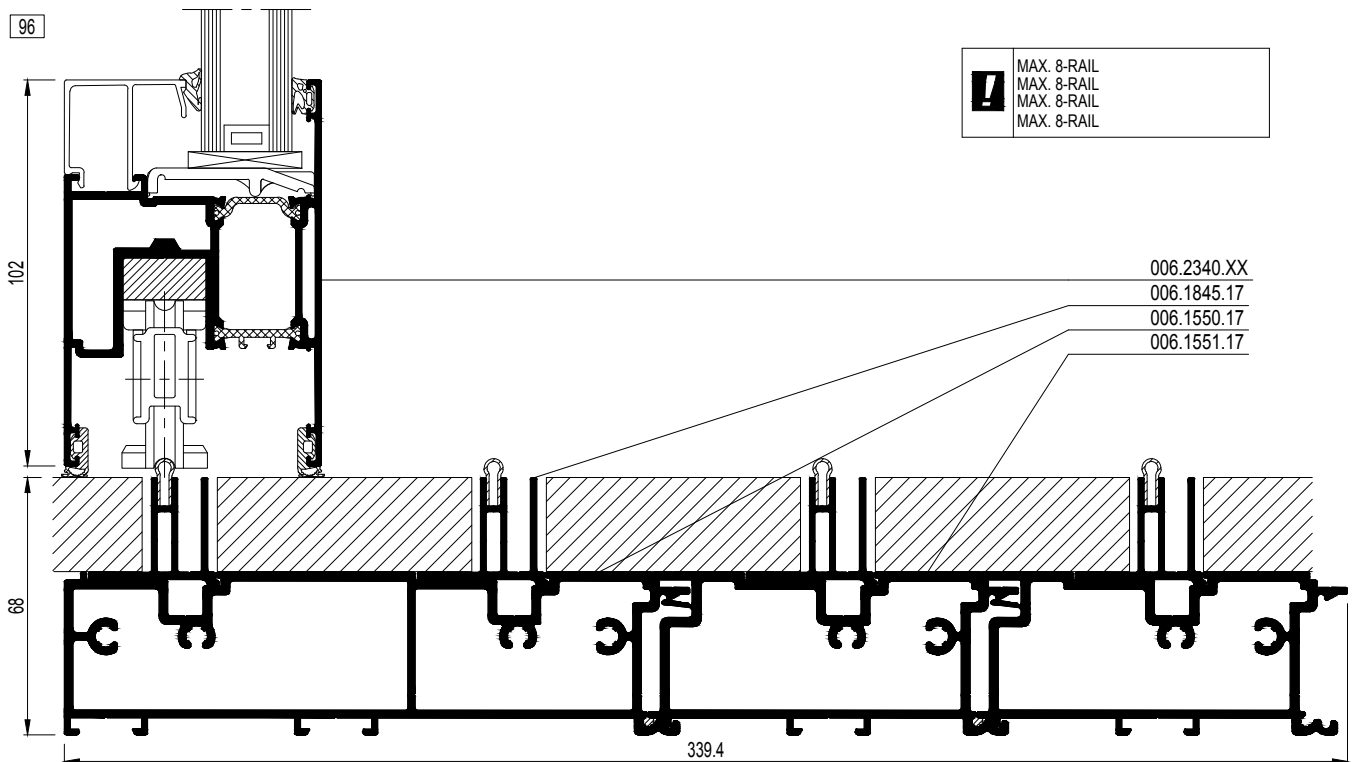

CP155LS-096001.dwg

D3002982

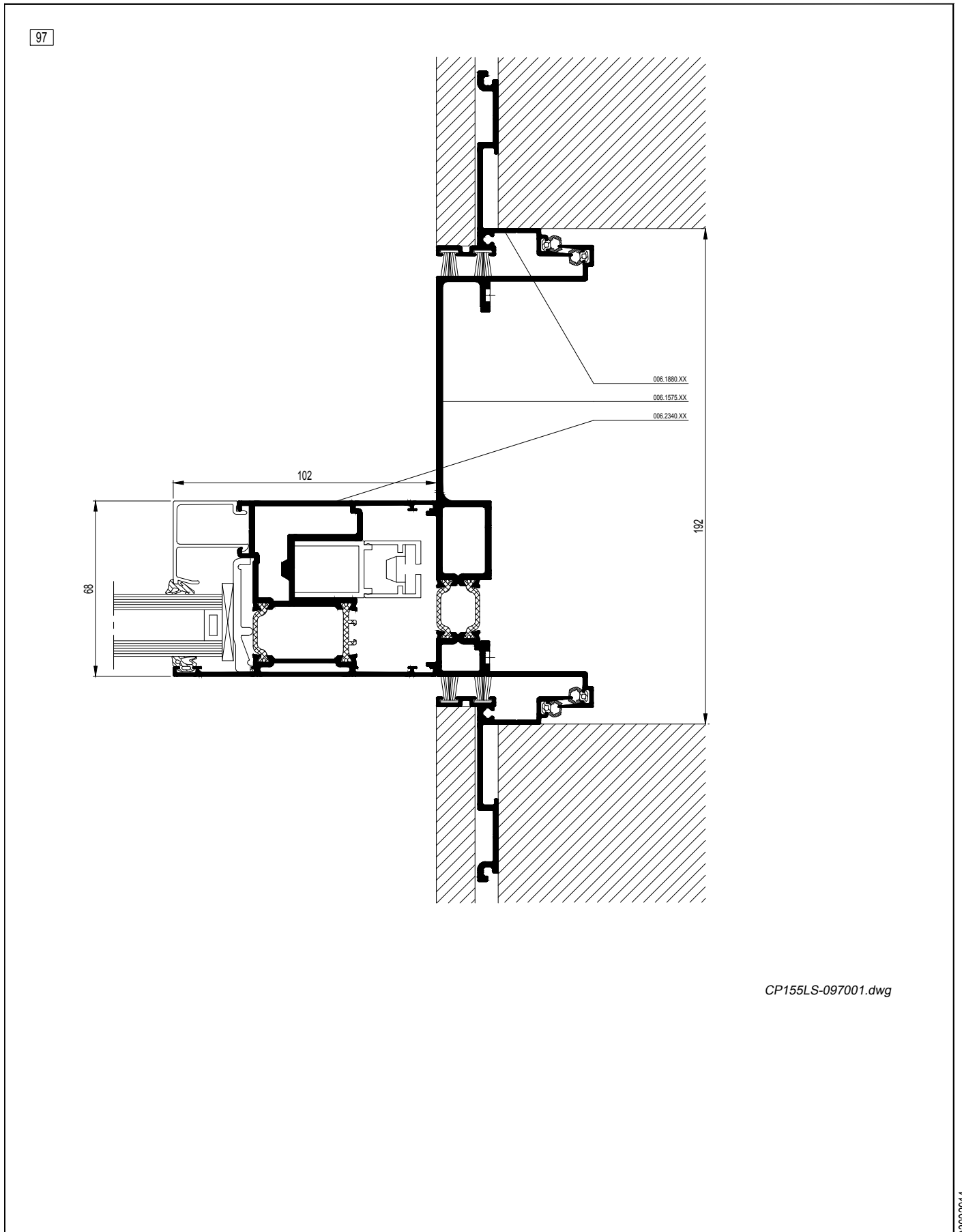
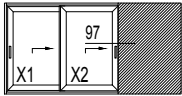

CP155LS-097001.dwg

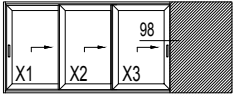

98

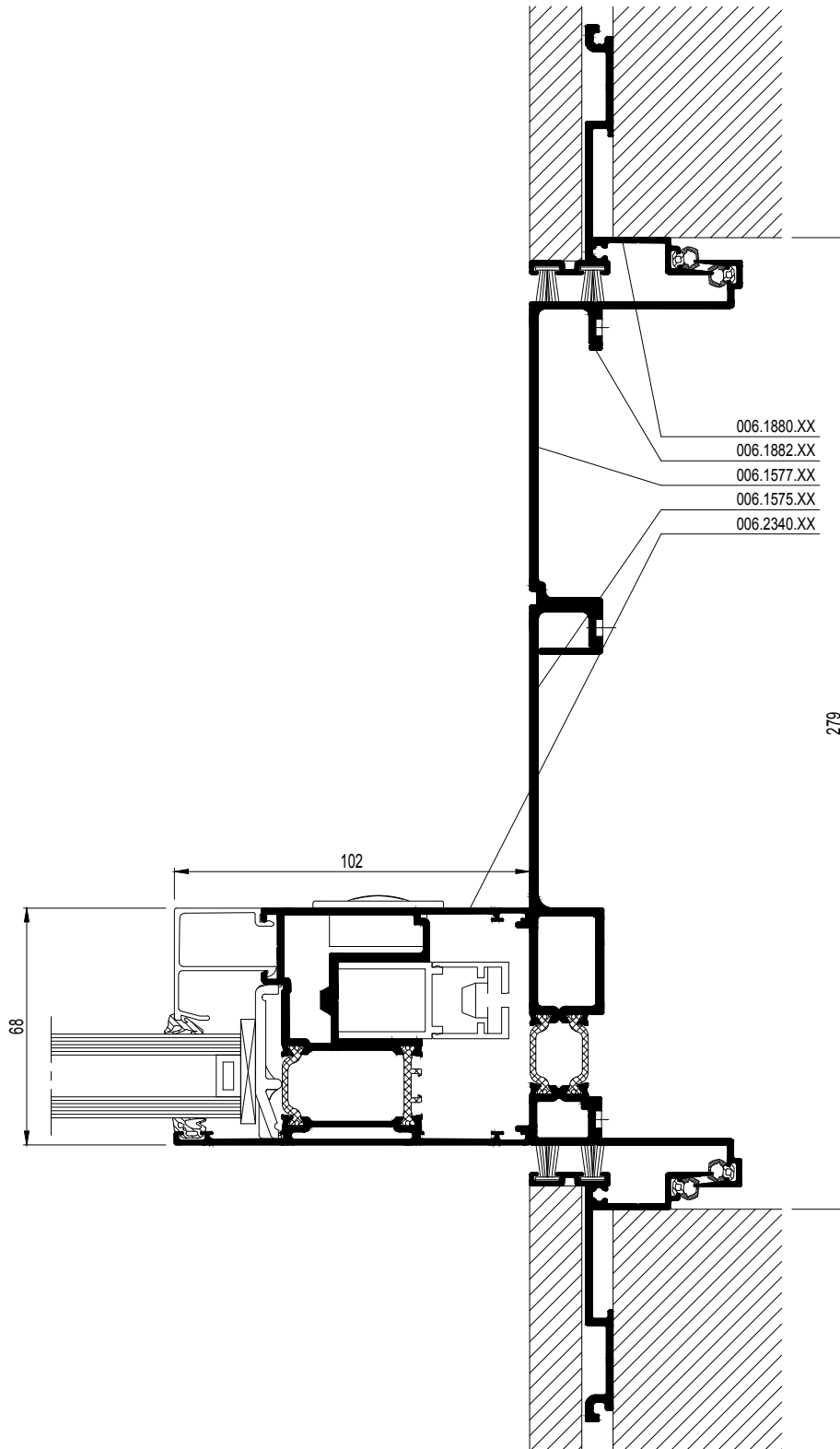

CP155LS-098001.dwg

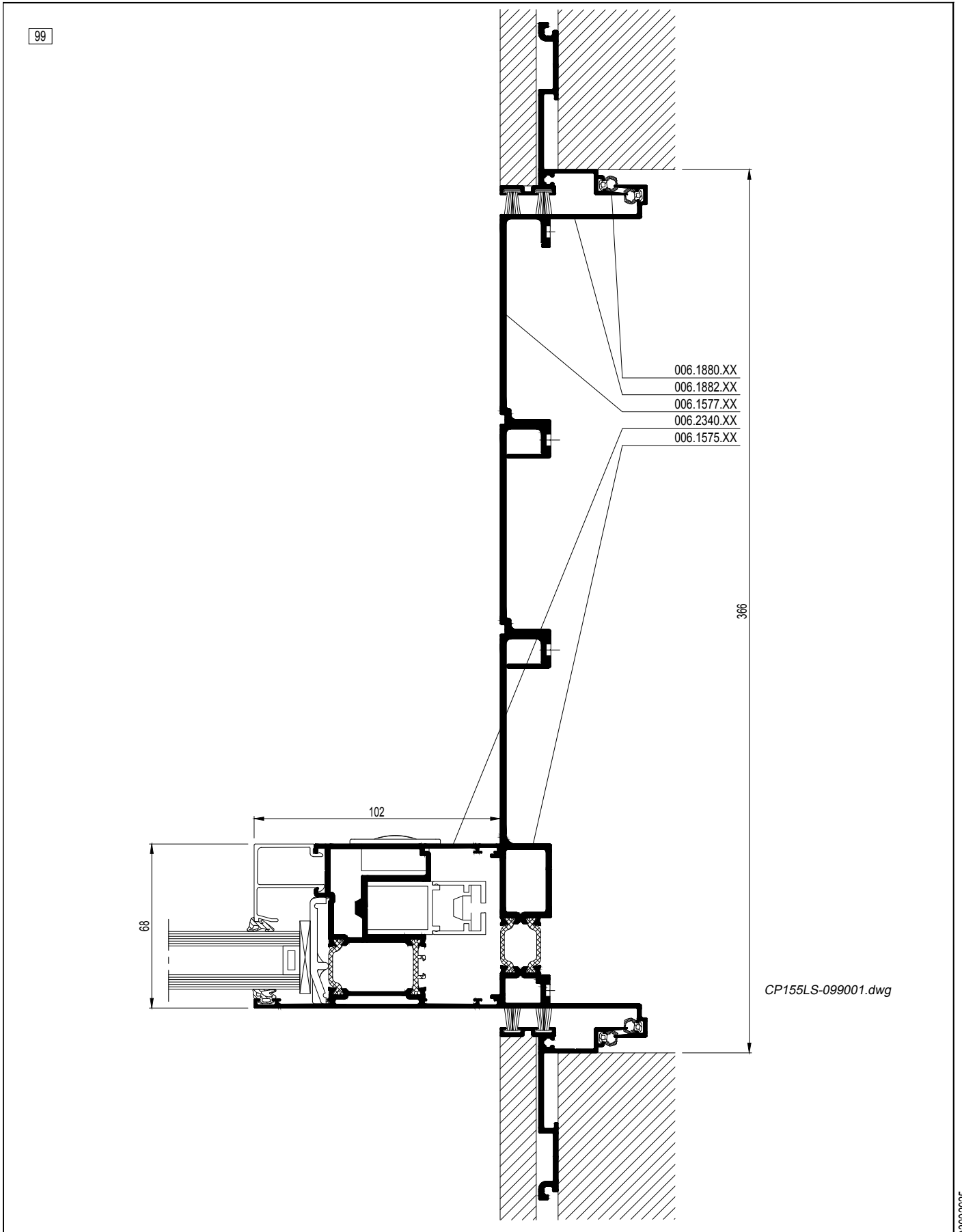
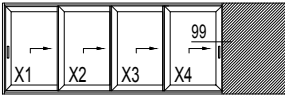

CP 155-LS

KOPPELINGEN BINNEN HET SYSTEEM - BUITENKADERS
COMBINAISONS DANS LE SYSTEME - DORMANTS
CONNECTIONS WITHIN THE SYSTEM - OUTER FRAMES
KOMBINATIONEN IN DEN SYSTEMEN - BLENDRAHMEN

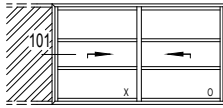
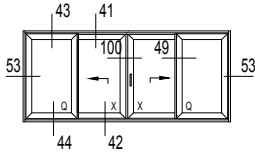
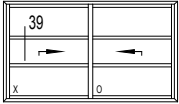

100

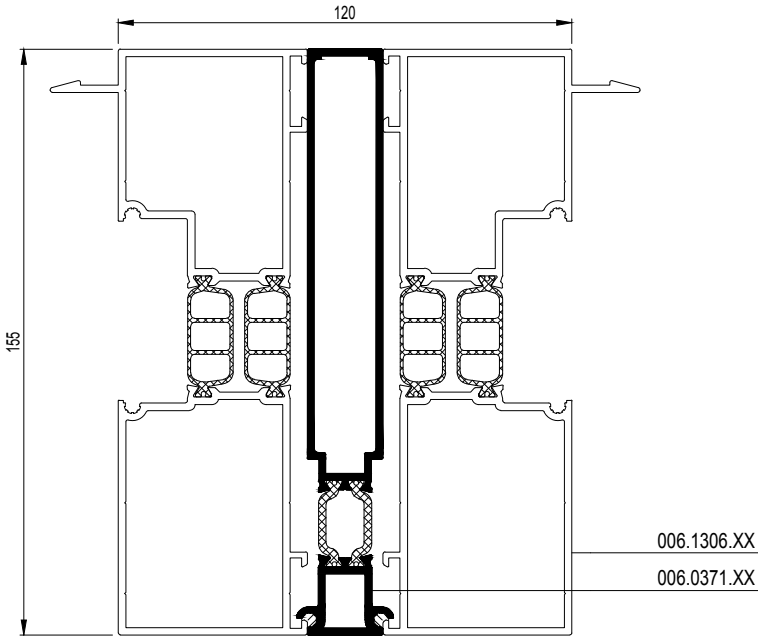

CP155LS-100001.dwg

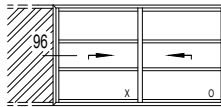
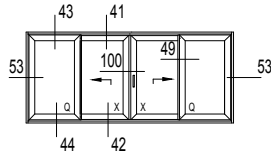
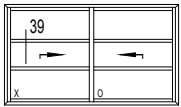

101

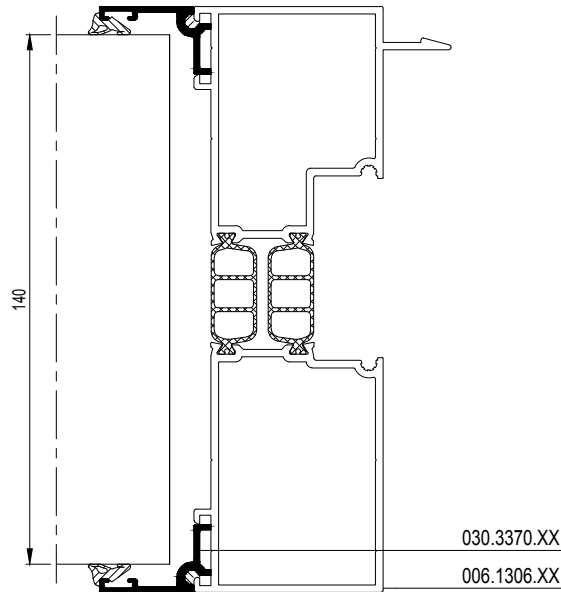

CP155LS-101002.dwg

101

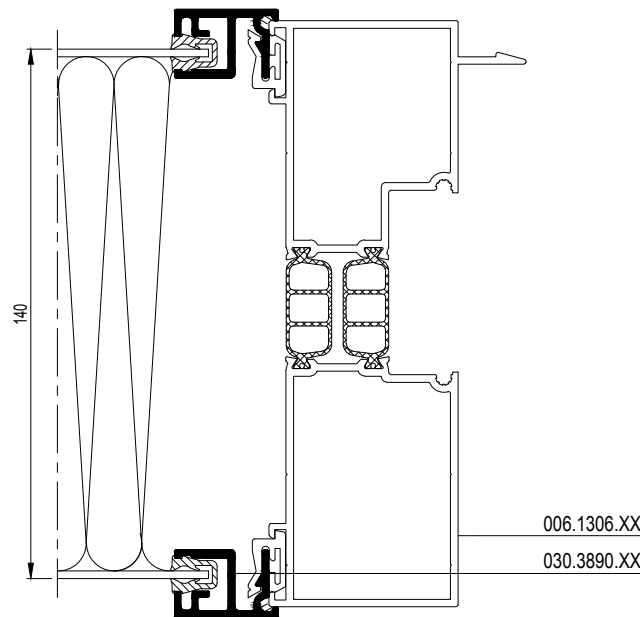

CP155LS-101001.dwg

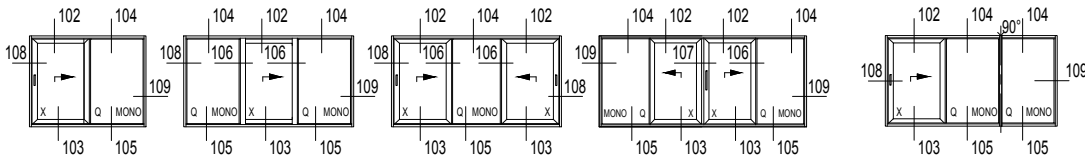

102

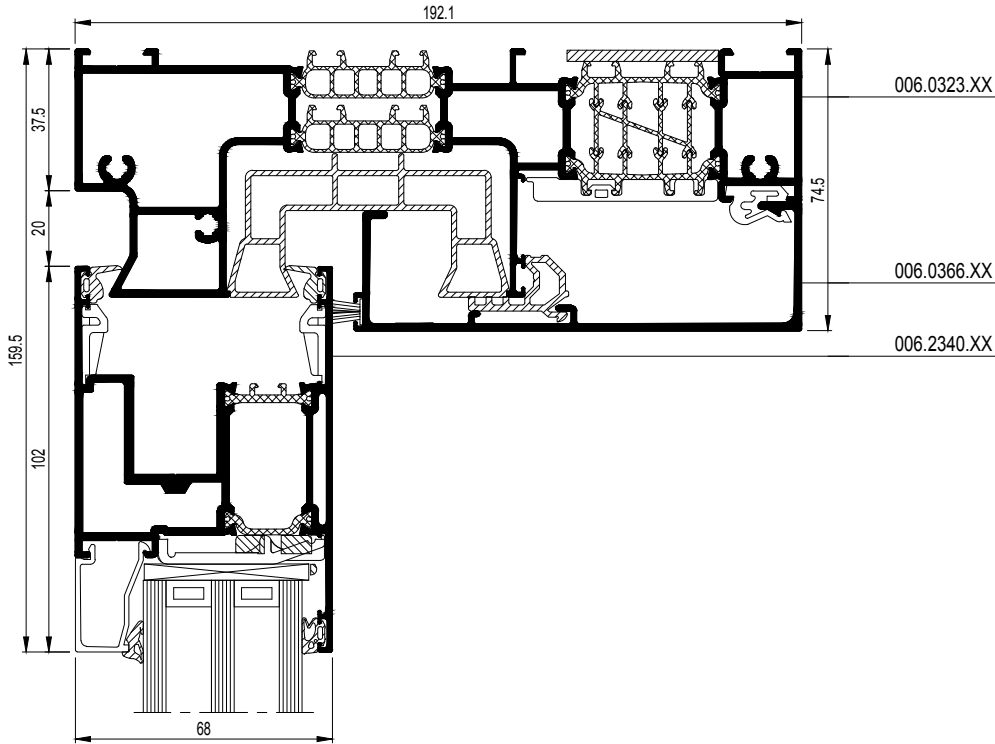

CP155LS-102001.dwg

103

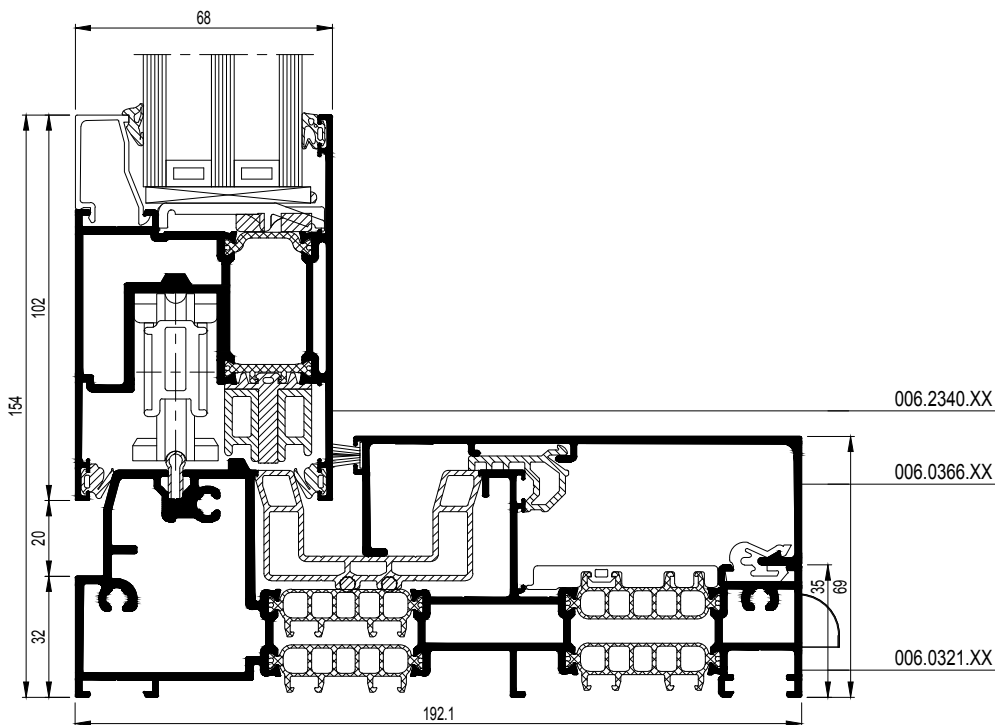

CP155LS-103001.dwg

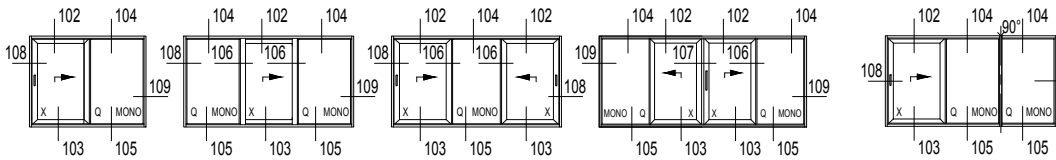

104

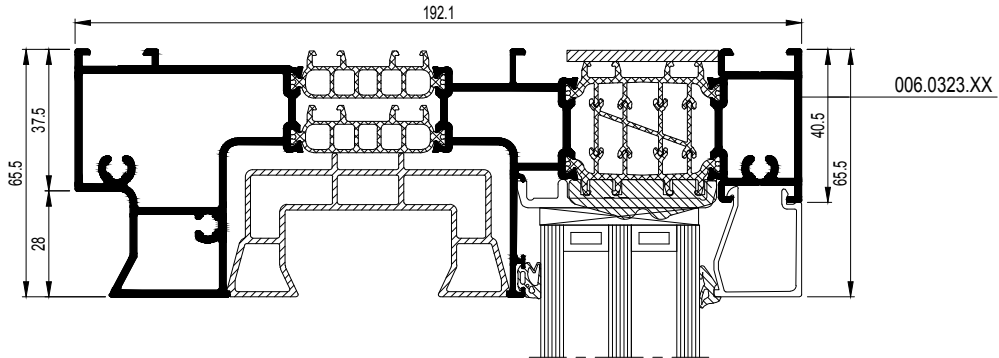

CP155LS-104001.dwg

105

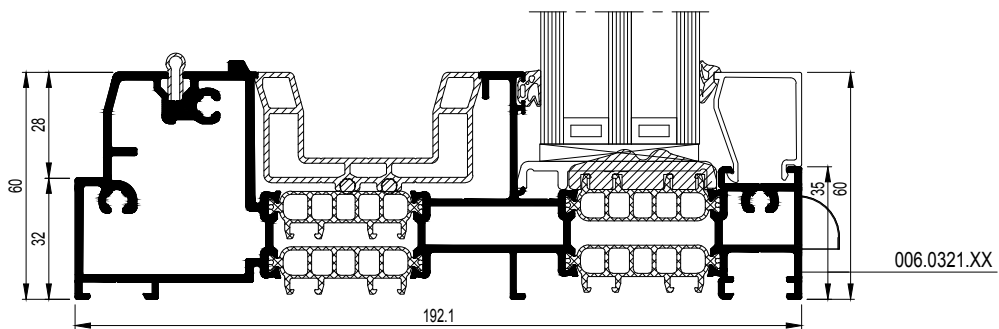

CP155LS-105001.dwg

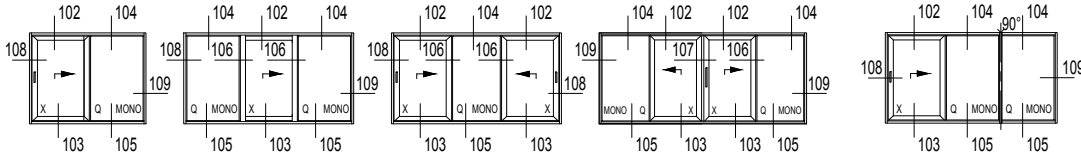

106

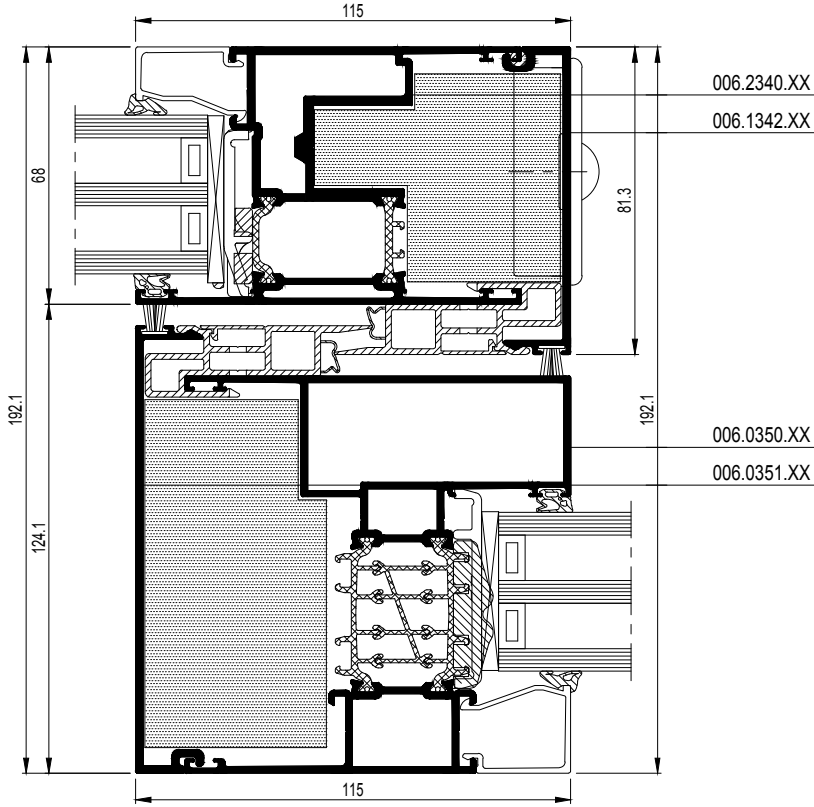

CP155LS-106001.dwg

107

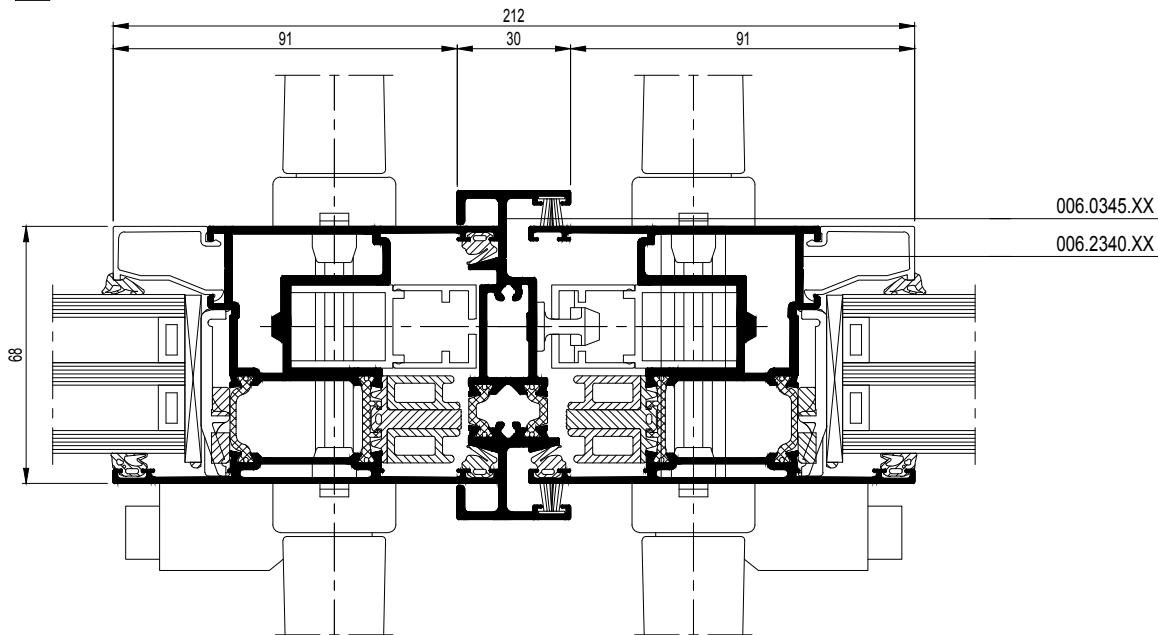

CP155LS-107001.dwg

CP 155-LS/HI

OPENGAANDE ELEMENTEN (MONORAIL) - MINERGIE
 ELEMENTS OUVRANTS (MONORAIL) - MINERGIE
 OPENING ELEMENTS (MONORAIL) - MINERGIE
 OEFFNENDE ELEMENTE (MONORAIL) - MINERGIE

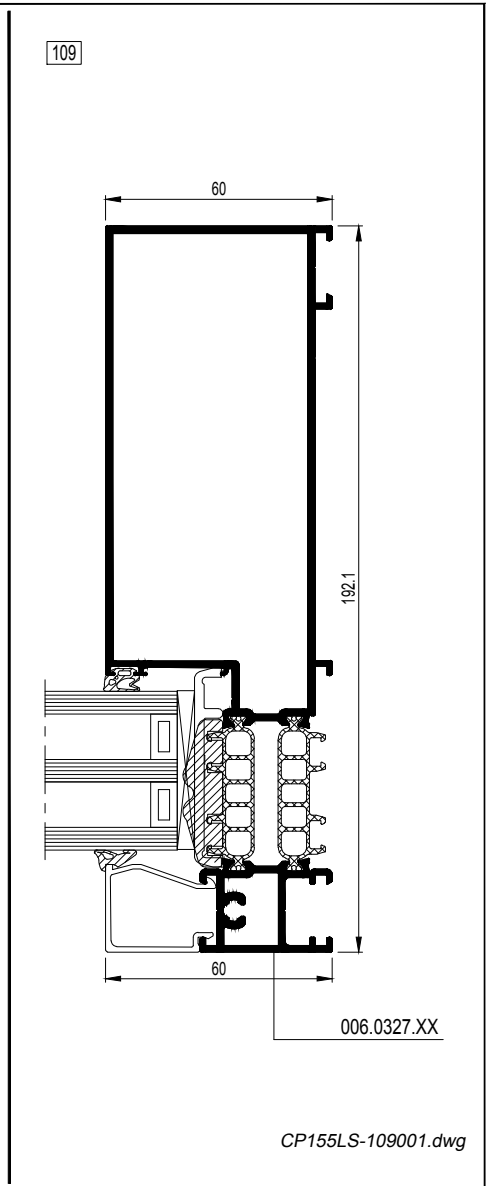
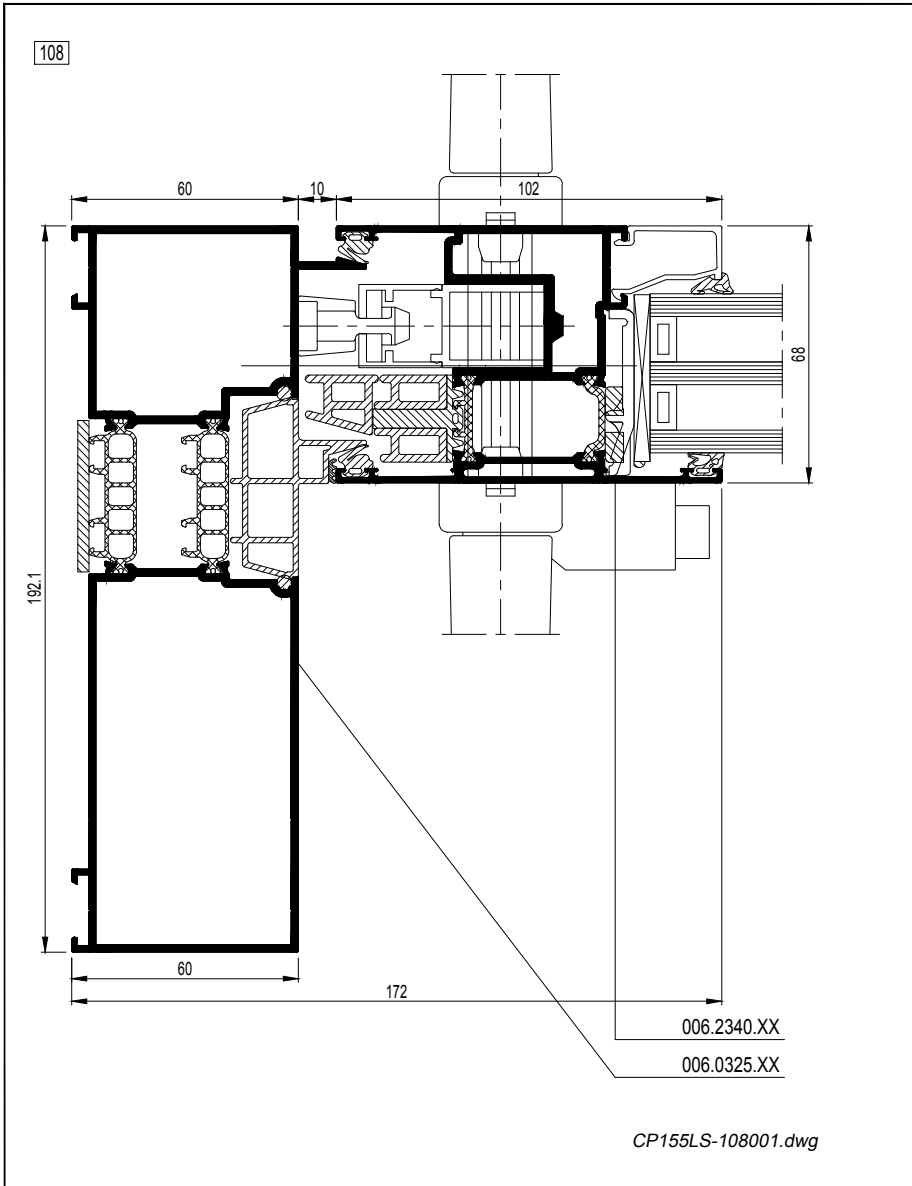
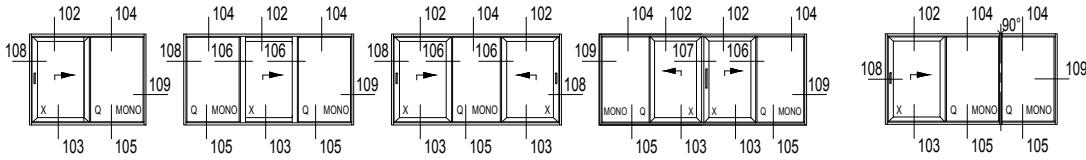

CP 155-AP

OPENGAANDE ELEMENTEN (DUORAIL) - BUITENKADERS
ELEMENTS OUVRANTS (DUORAIL) - DORMANTS
OPENING ELEMENTS (DUORAIL) - OUTER FRAMES
OEFFNENDE ELEMENTE (DOURAIL) - BLENDRAHMEN

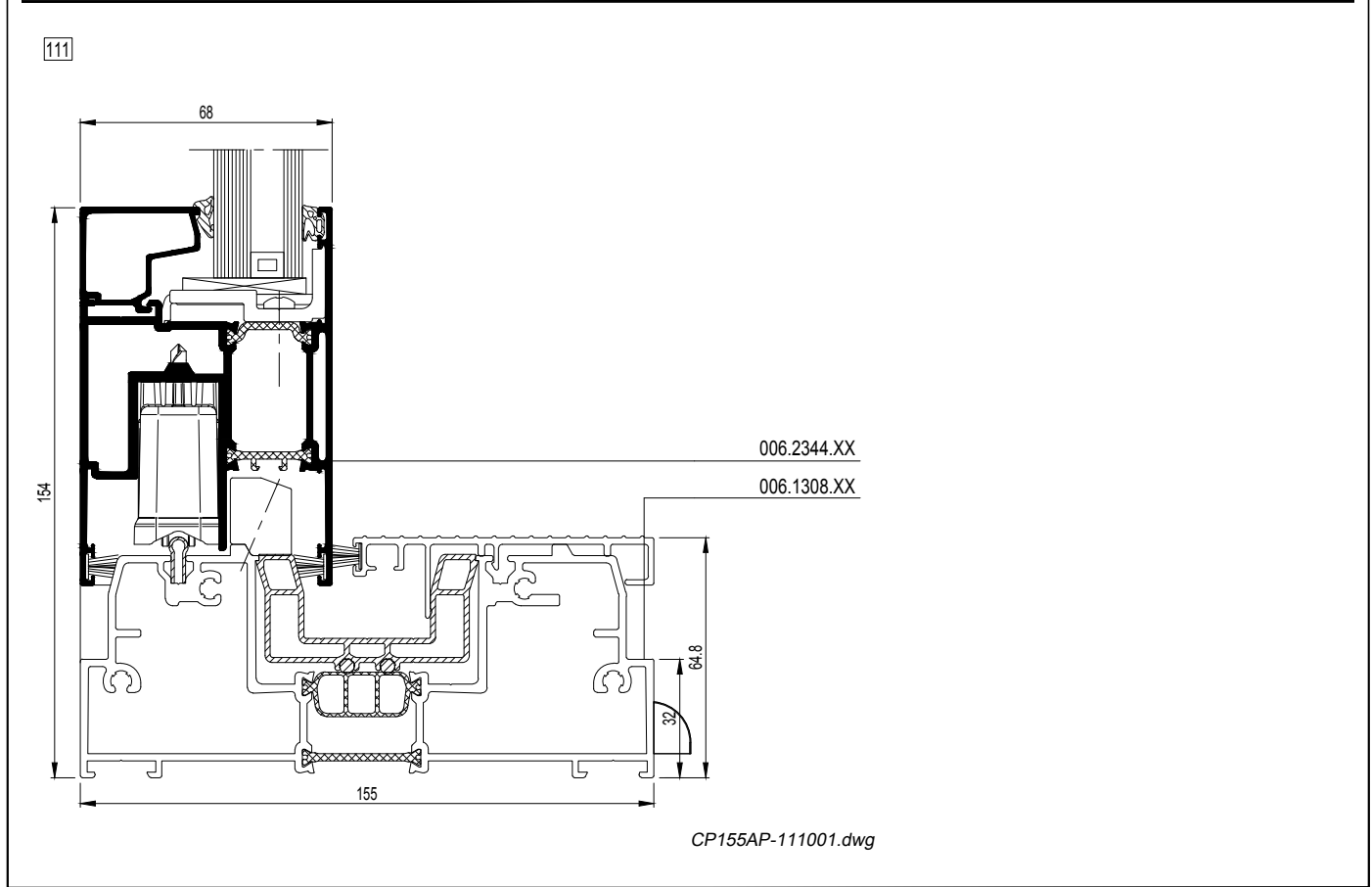
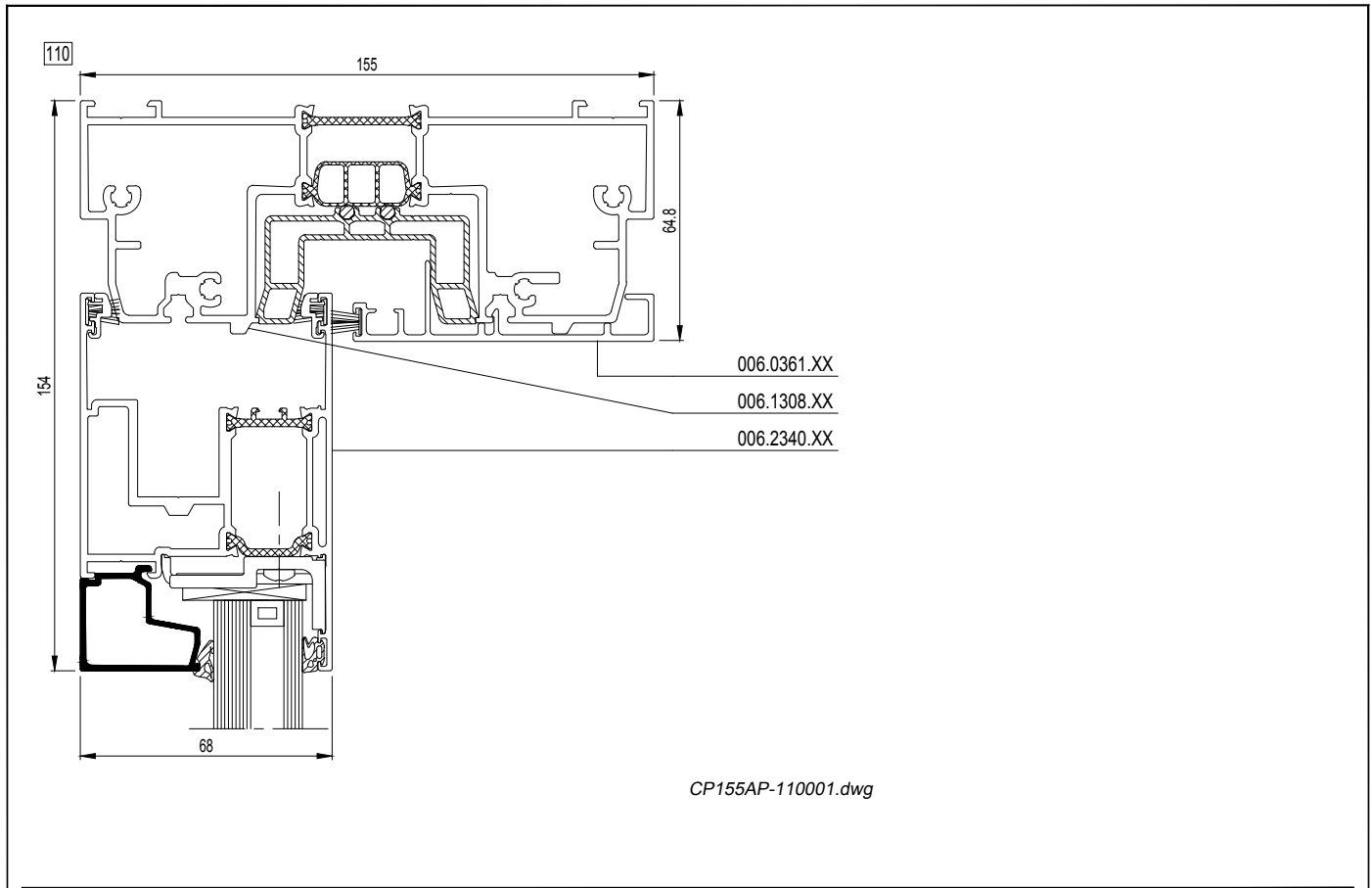
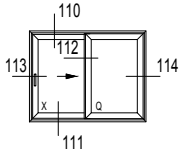

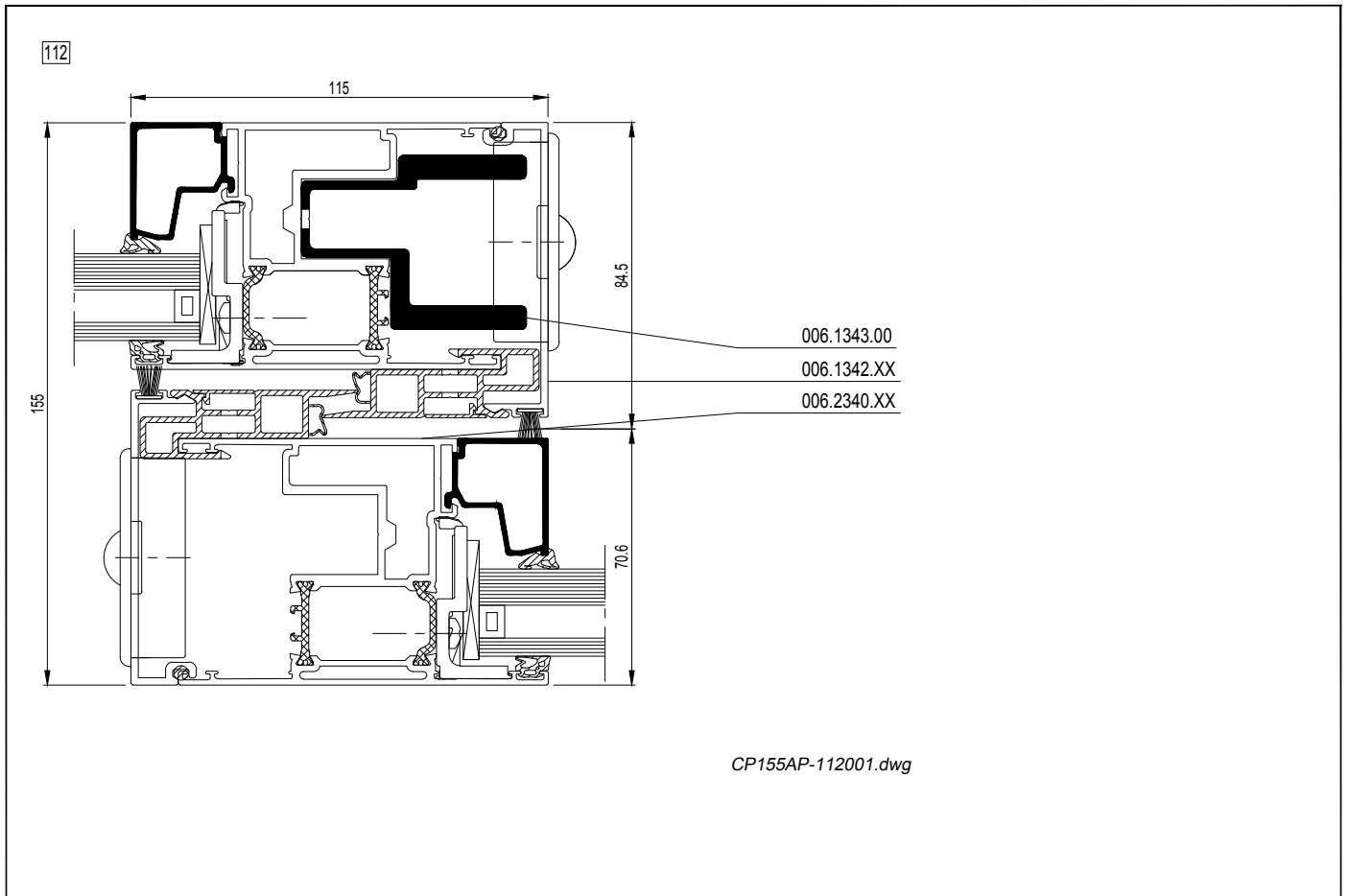
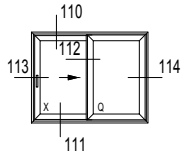

CP155AP-112001.dwg

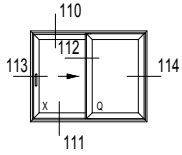

113

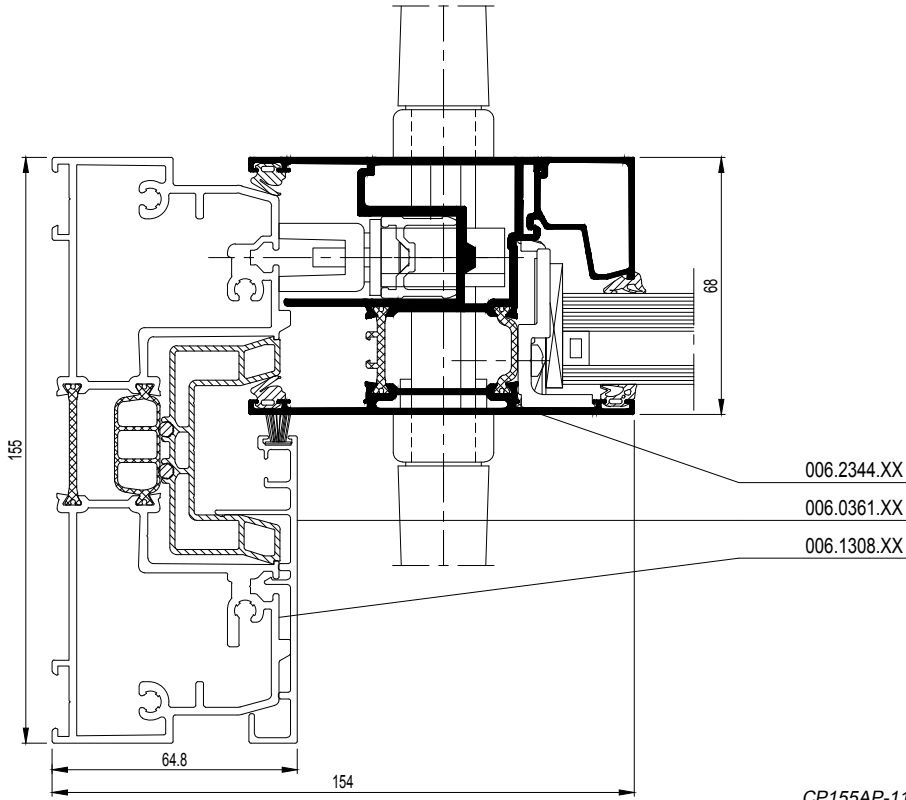

CP155AP-113001.dwg

114

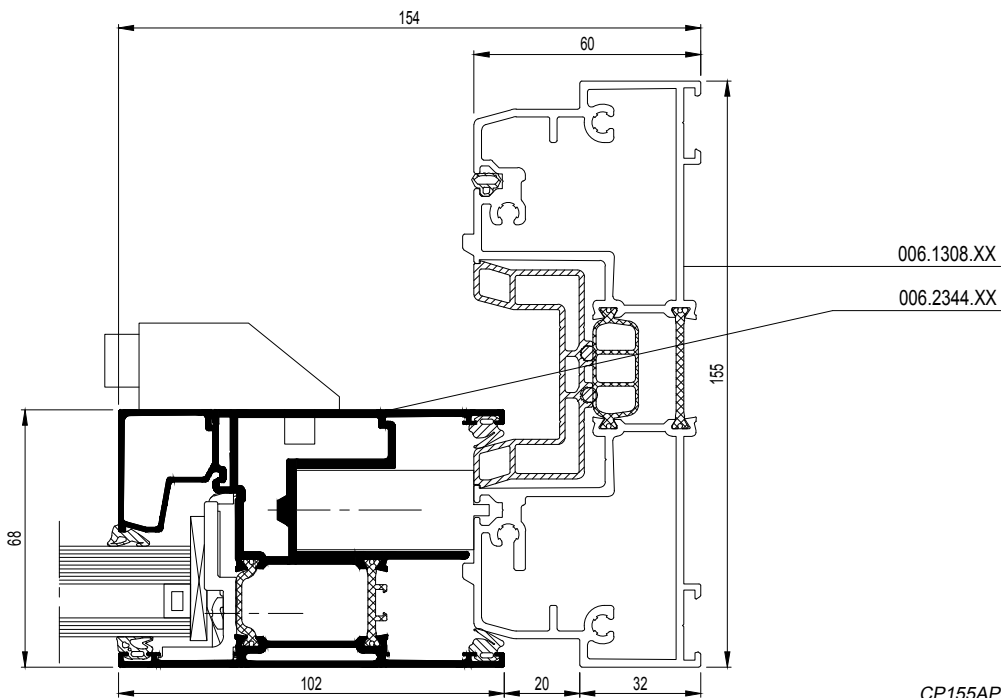

CP155AP-114001.dwg

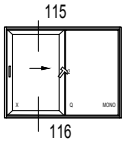

115

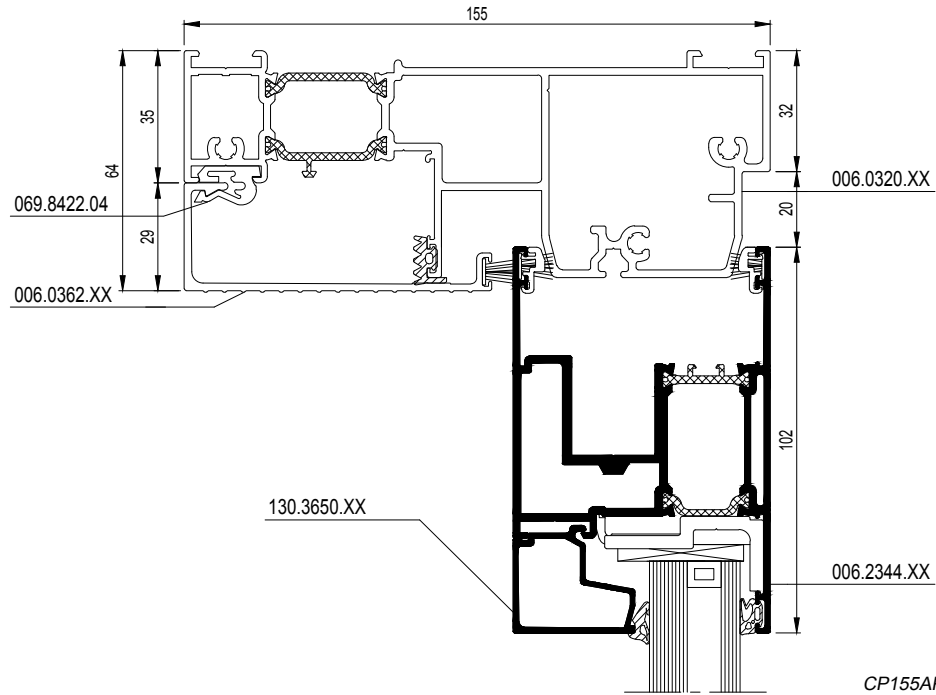

116

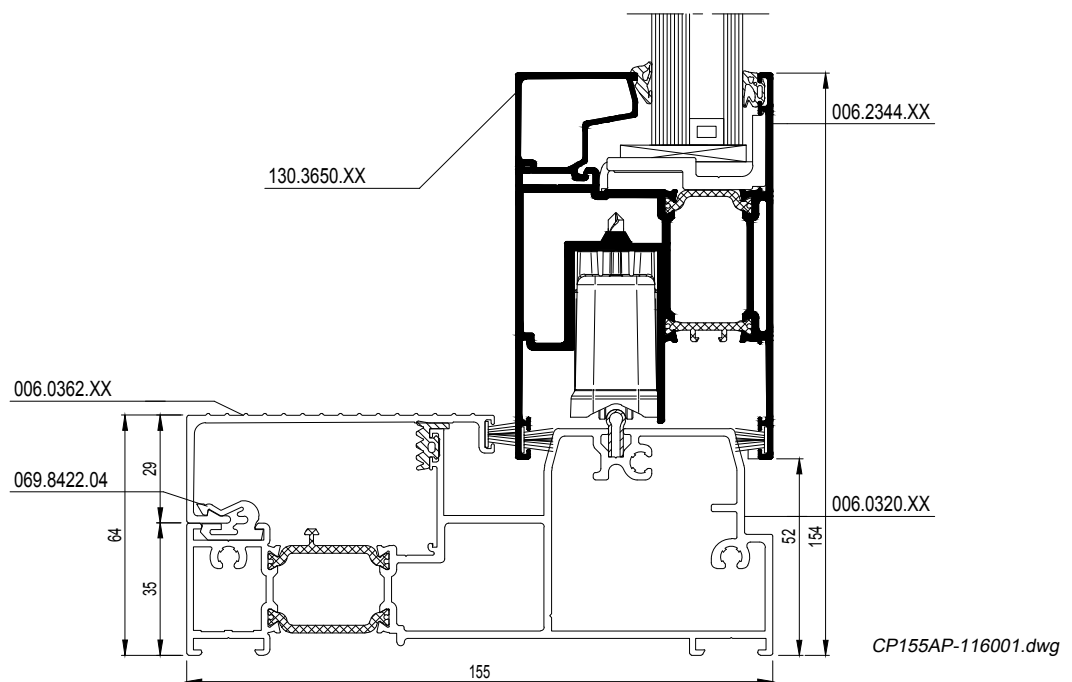

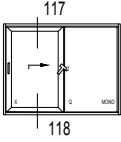

117

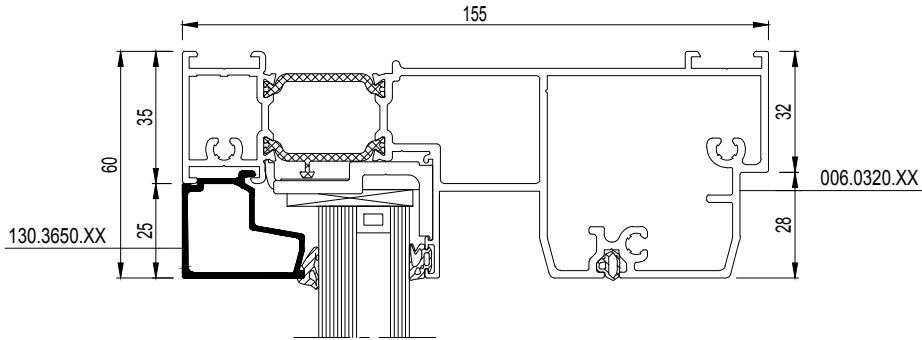

CP155AP-117001.dwg

118

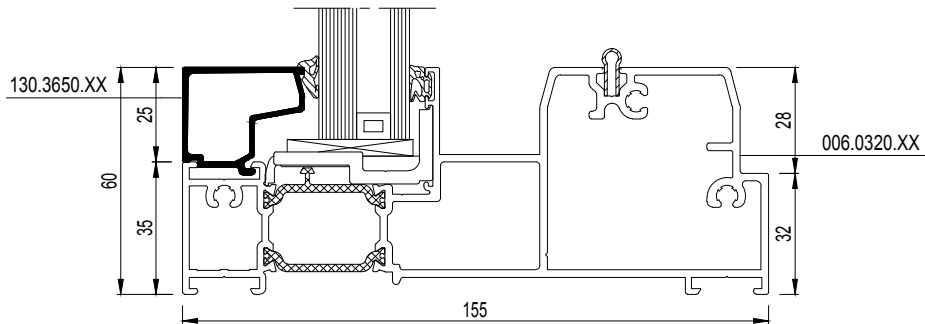

CP155AP-118001.dwg

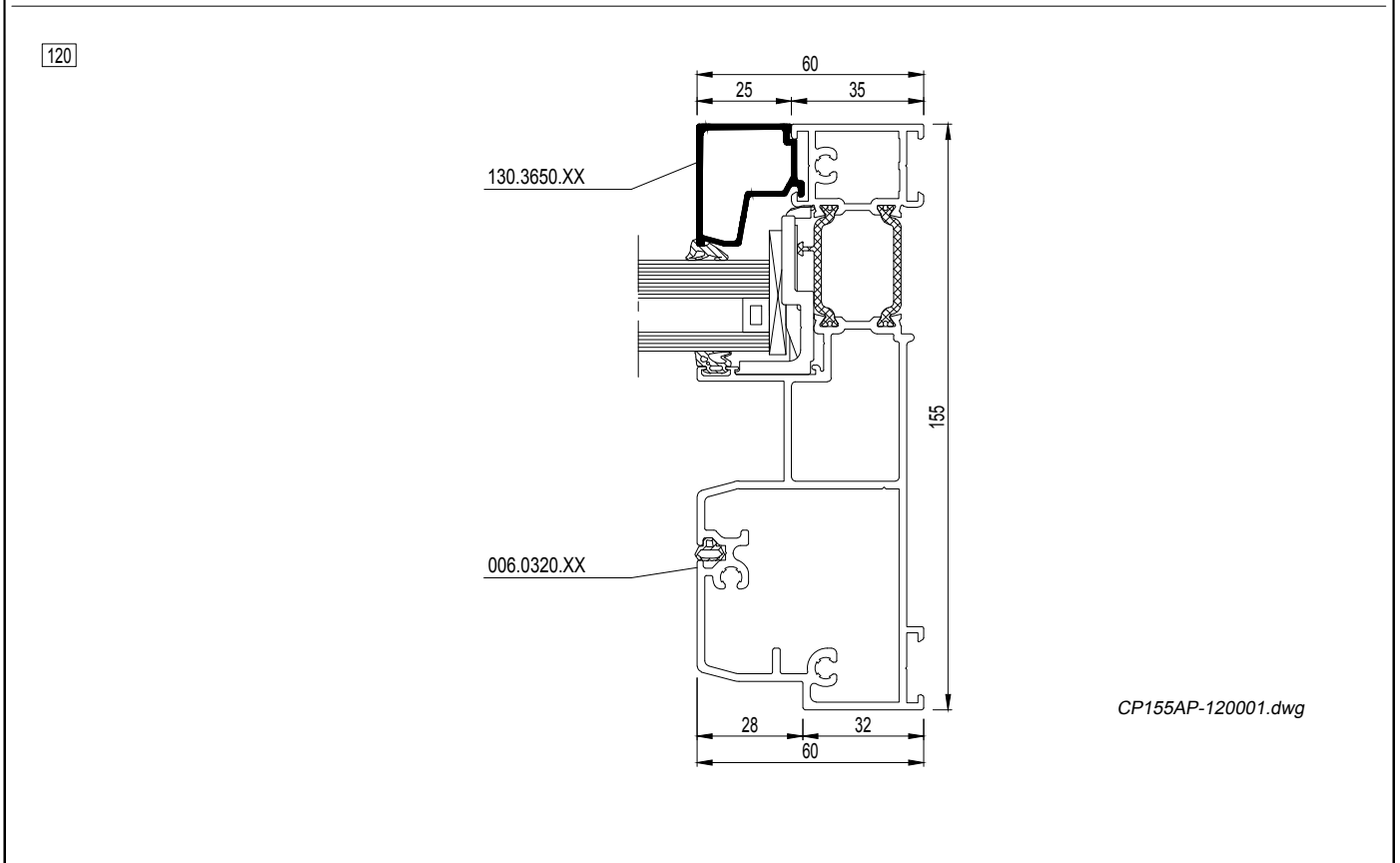
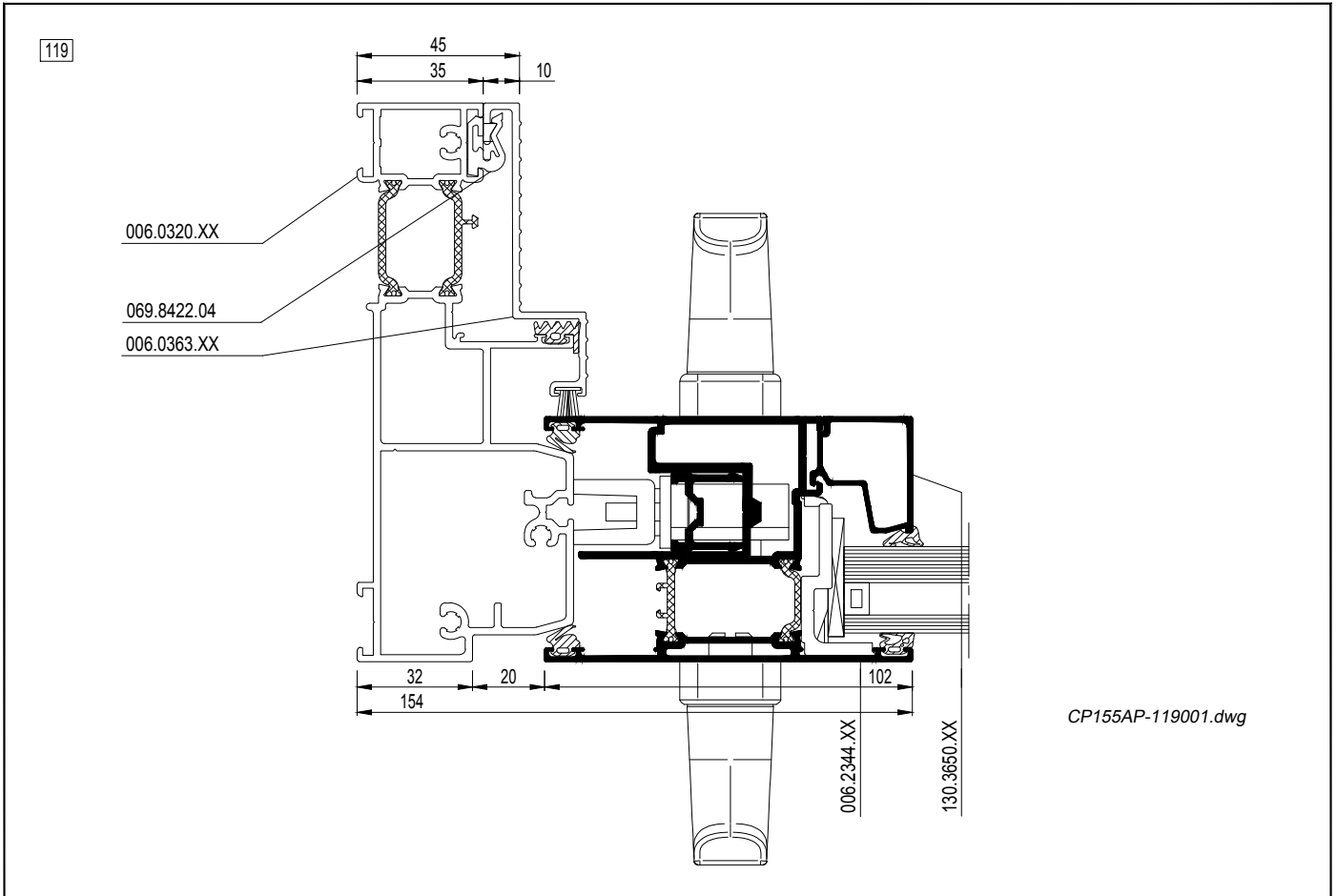
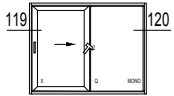

CP 155-LS/AP

OPENGAANDE ELEMENTEN (DUORAIL) - BUITENKADERS
ELEMENTS OUVRANTS (DUORAIL) - DORMANTS
OPENING ELEMENTS (DUORAIL) - OUTER FRAMES
OEFFNENDE ELEMENTE (DOURAIL) - BLENDRAHMEN

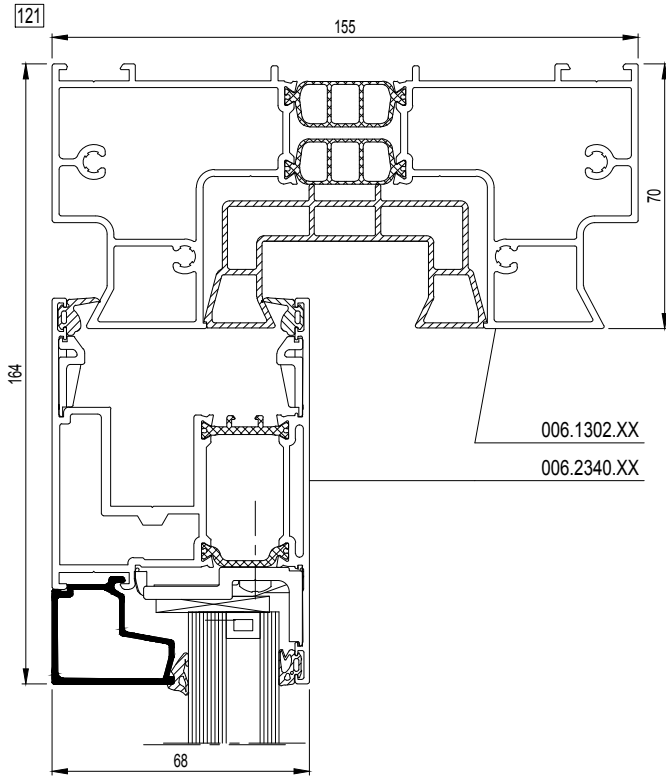
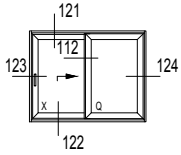

CP155AP-121001.dwg

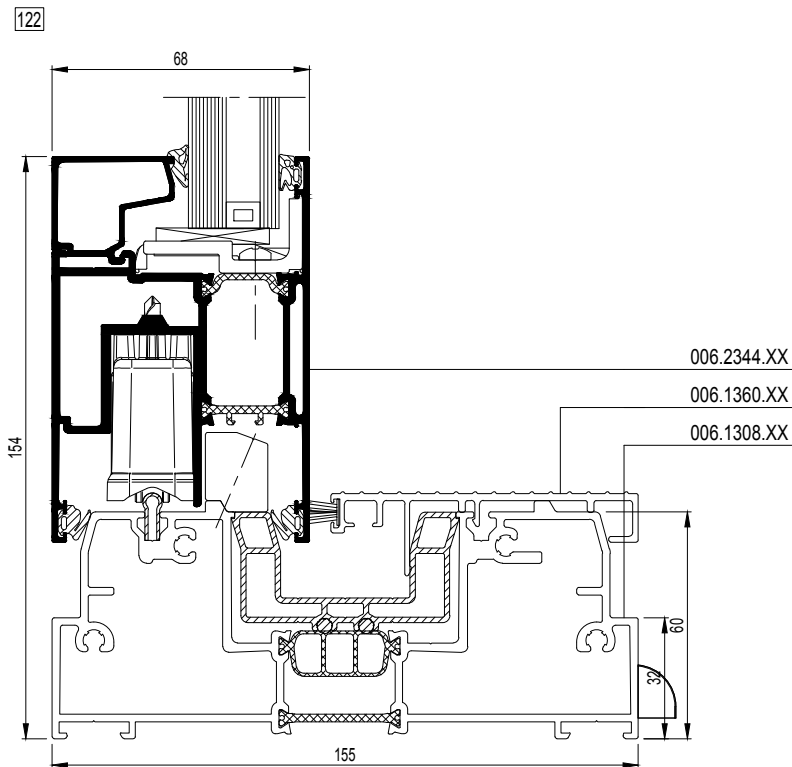

CP155AP-122001.dwg

CP 155-LS/AP

OPENGAANDE ELEMENTEN (DUORAIL) - BUITENKADERS
ELEMENTS OUVRANTS (DUORAIL) - DORMANTS
OPENING ELEMENTS (DUORAIL) - OUTER FRAMES
OEFFNENDE ELEMENTE (DORAIL) - BLENDRAHMEN

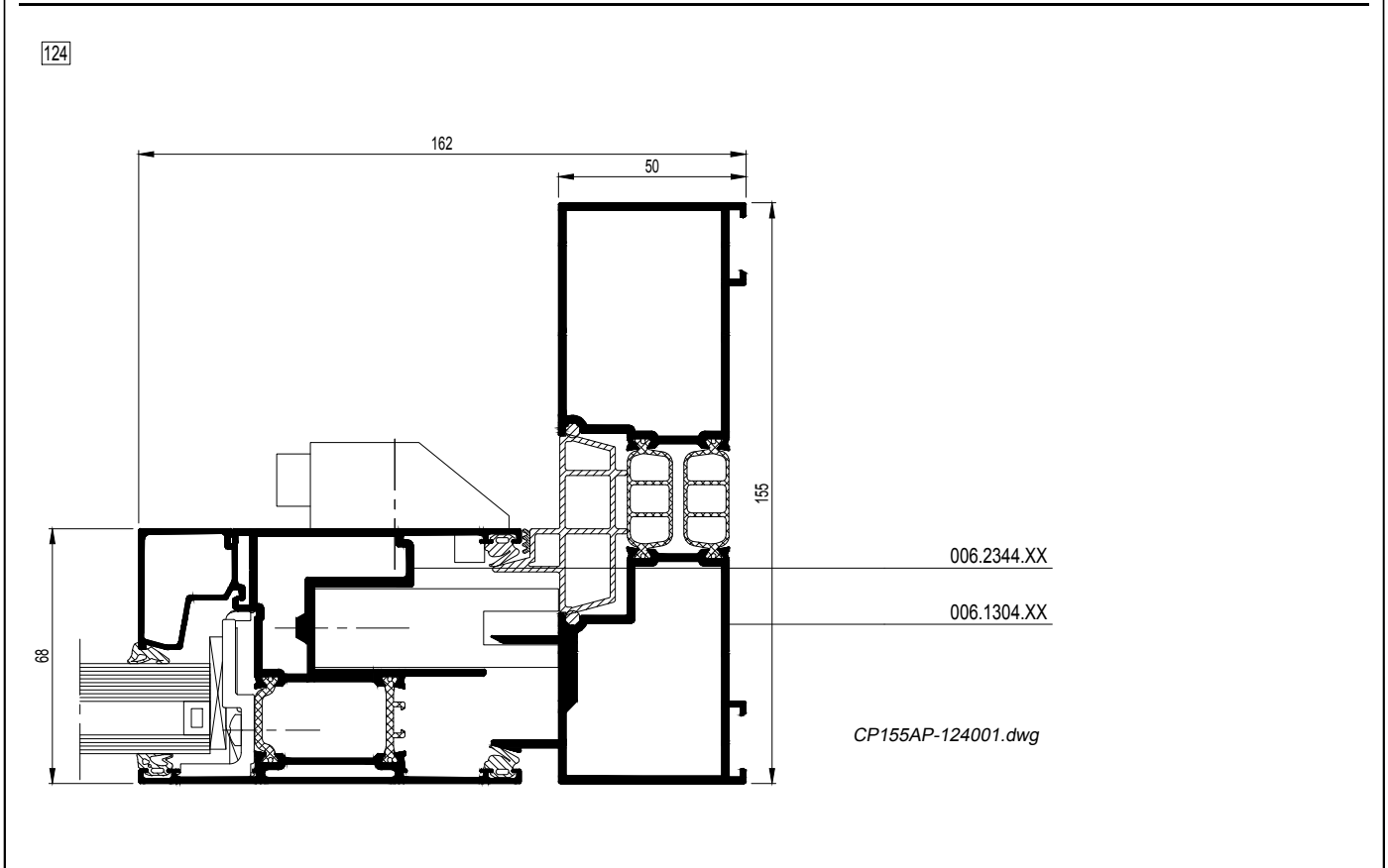
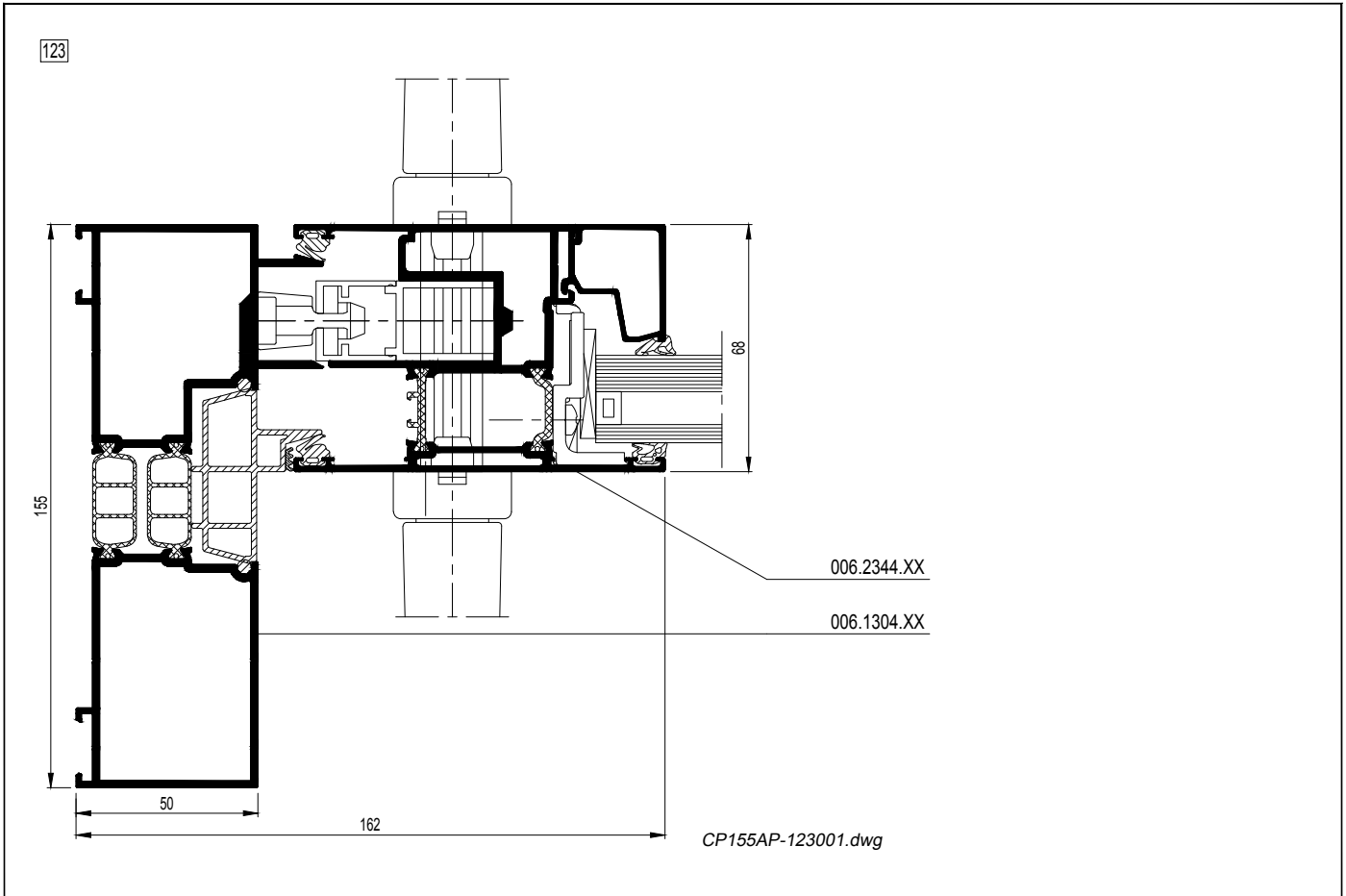
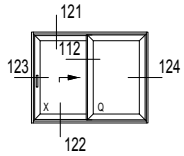

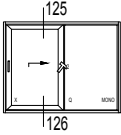

125

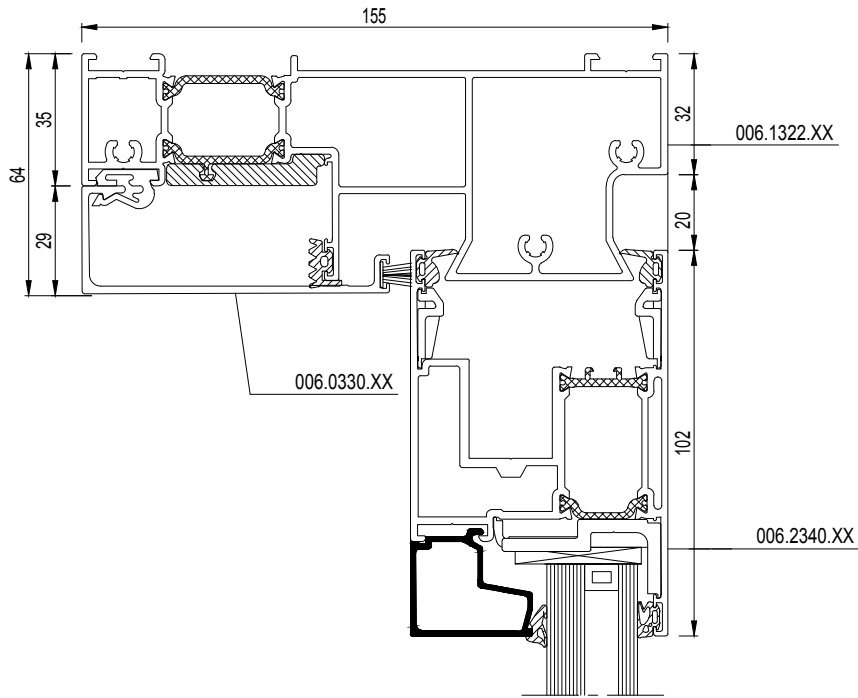

CP155AP-125001.dwg

126

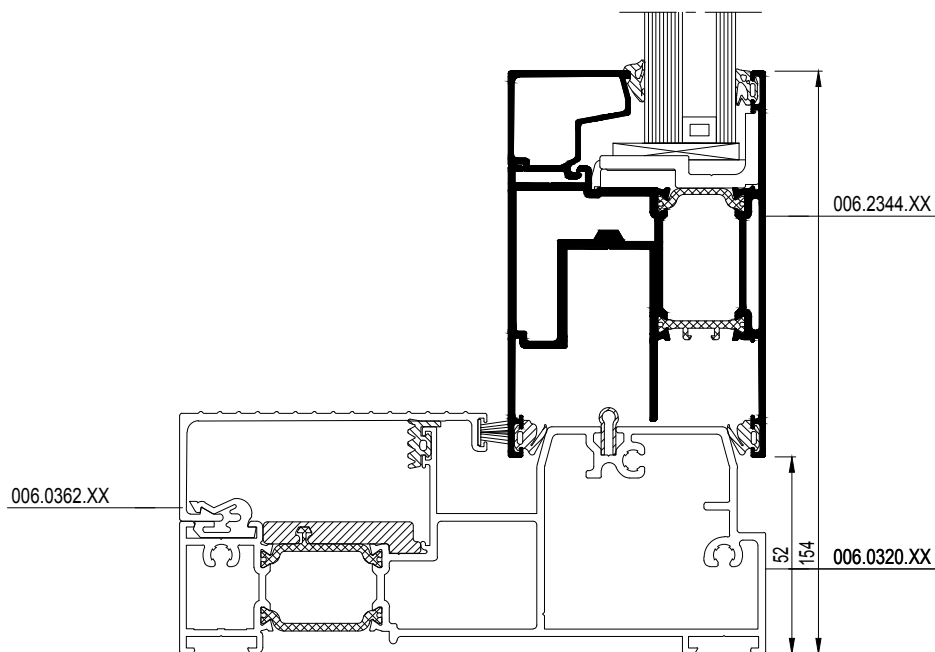

CP155AP-126001.dwg

CP 155-LS/AP

OPENGAANDE ELEMENTEN (MONORAIL) - BUITENKADERS
ELEMENTS OUVRANTS (MONORAIL) - DORMANTS
OPENING ELEMENTS (MONORAIL) - OUTER FRAMES
OEFFNENDE ELEMENTE (MONORAIL) - BLENDRAHMEN

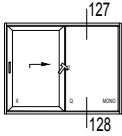

127

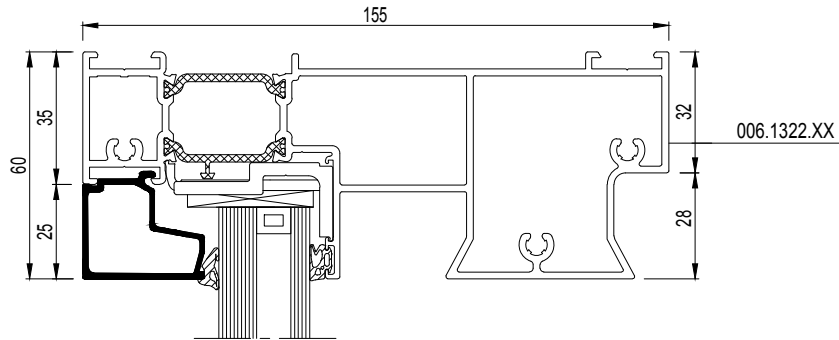

CP155AP-127001.dwg

128

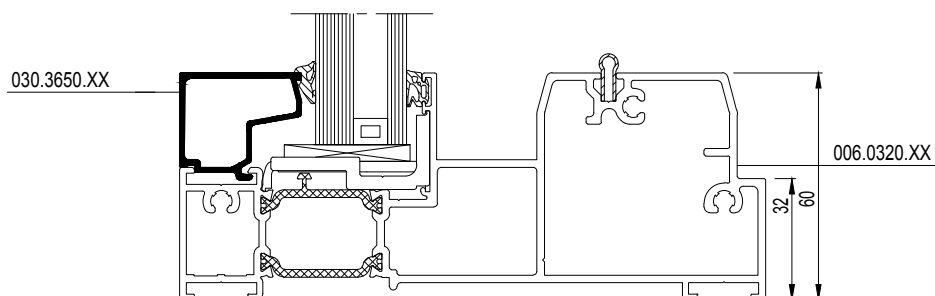

CP155AP-128001.dwg

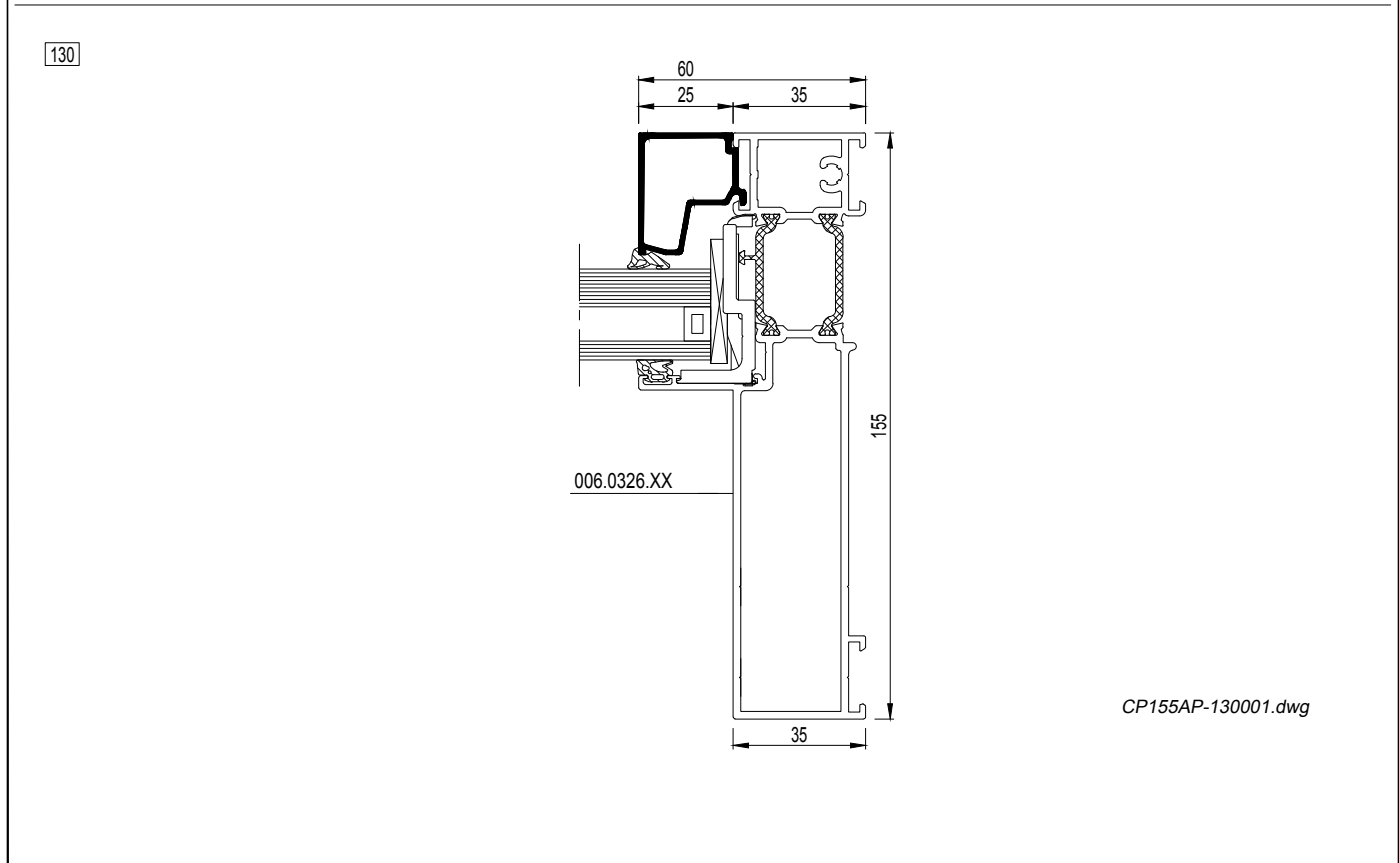
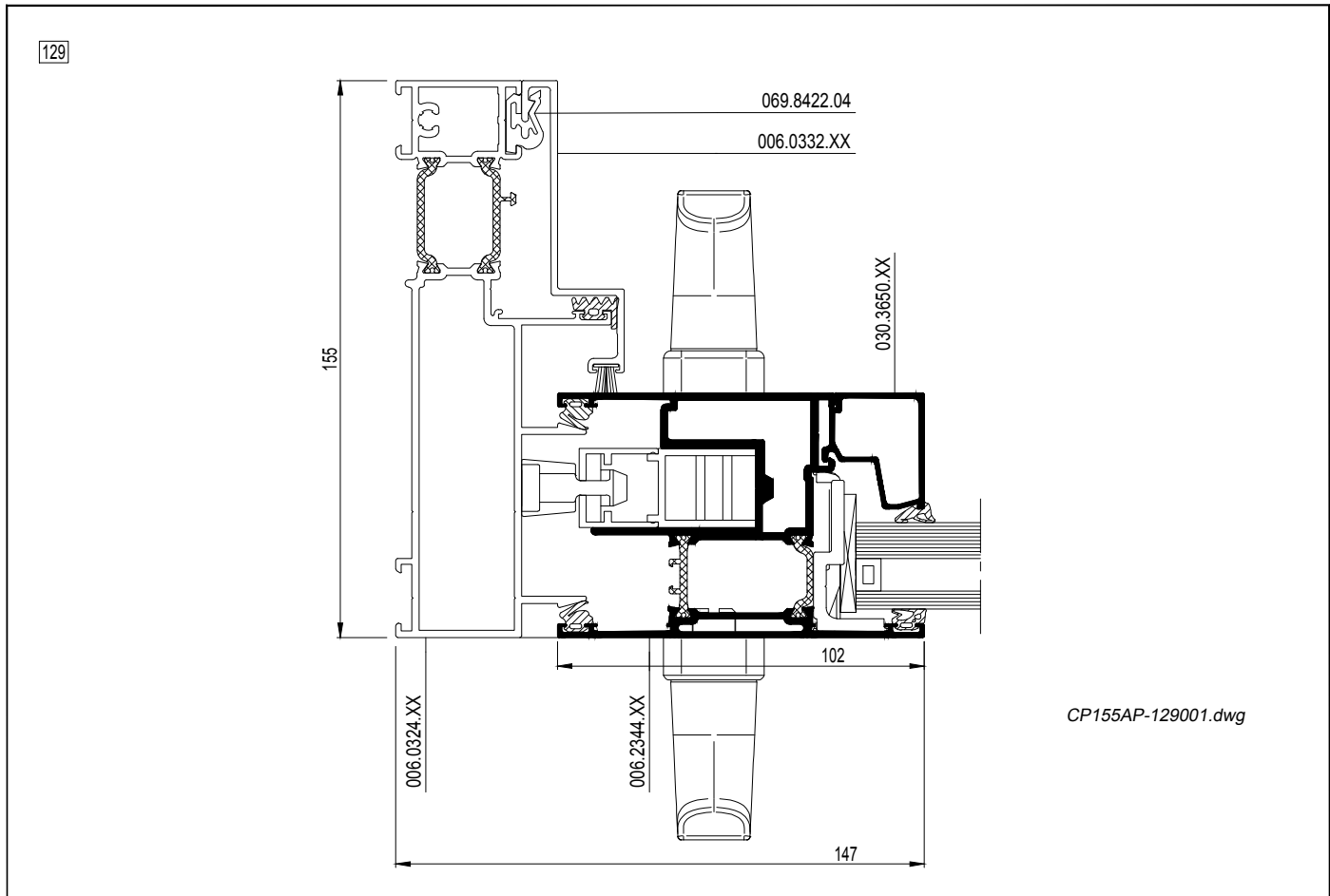
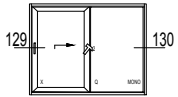

KOPPELINGEN MET ANDERE SYSTEMEN
COMBINAISONS AVEC D'AUTRES SYSTEMES

CONNECTIONS WITH OTHER SYSTEMS
KOMBINATIONEN MIT ANDEREN SYSTEMEN

CS 68

CS 77

SL 38

MASTERLINE 8

MASTERLINE 10

CW 50

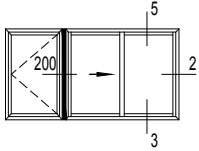

CS 68

200

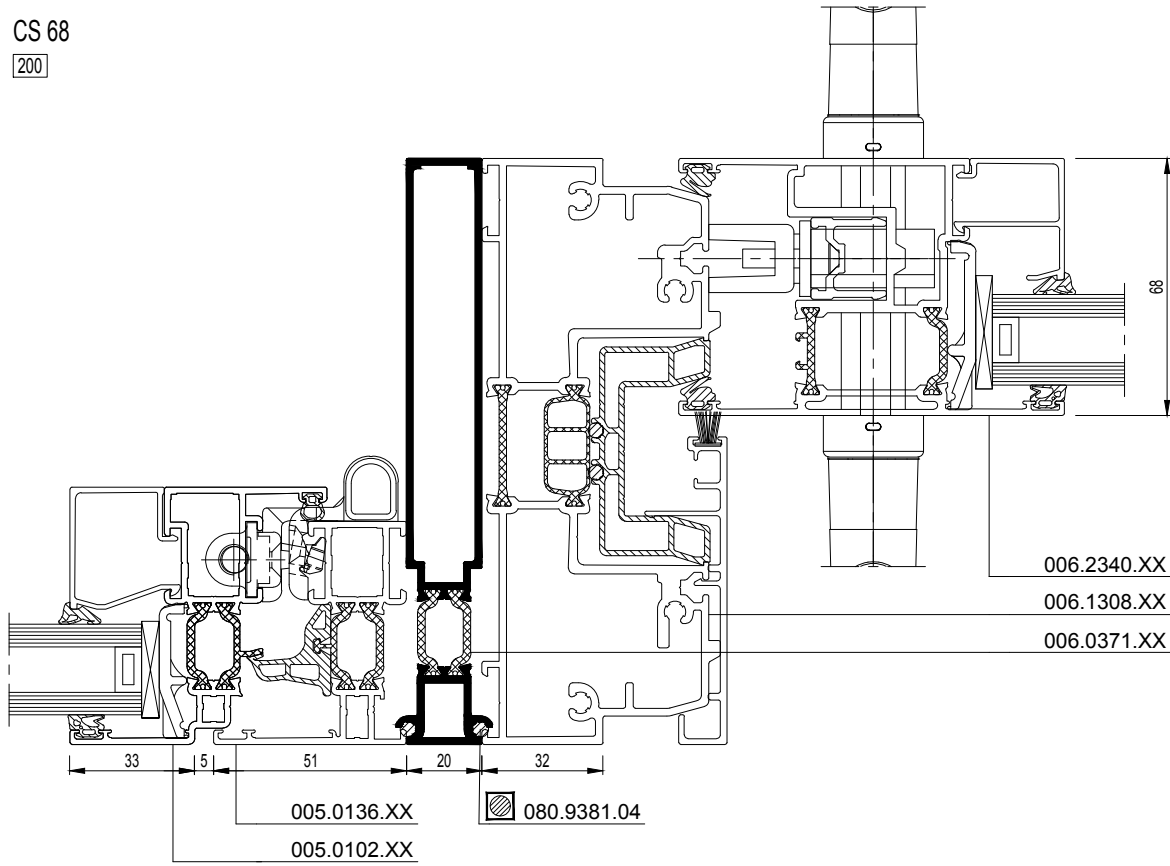

CP155-200001.dwg

CS 68

200

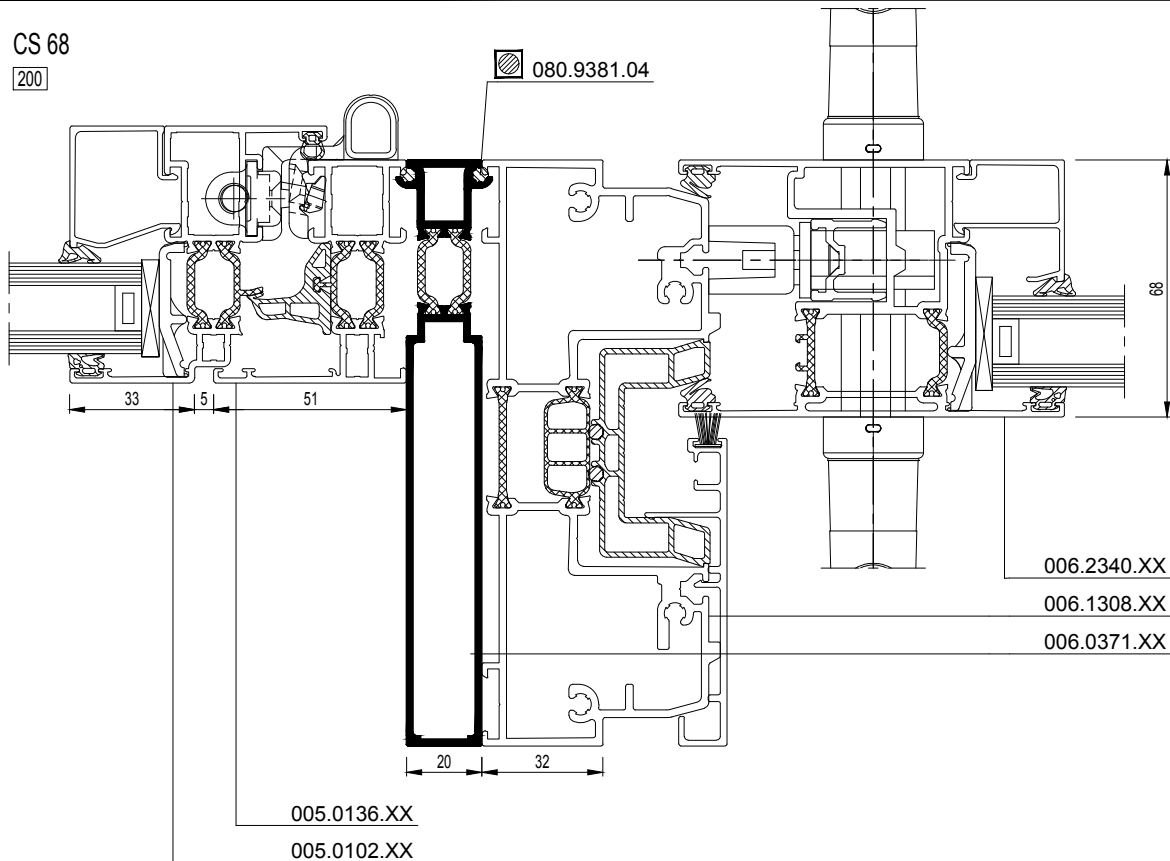

CP155-200002.dwg

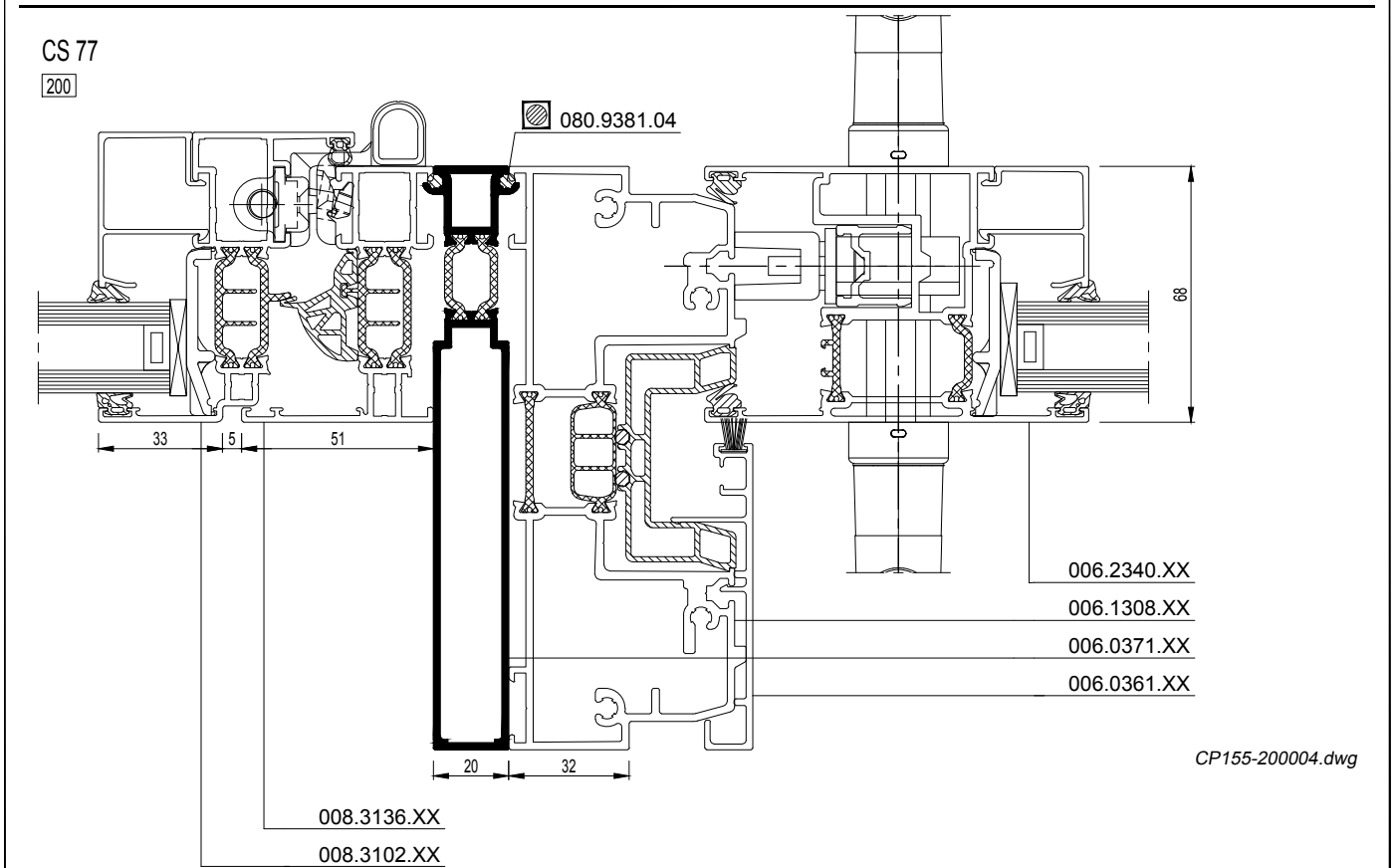
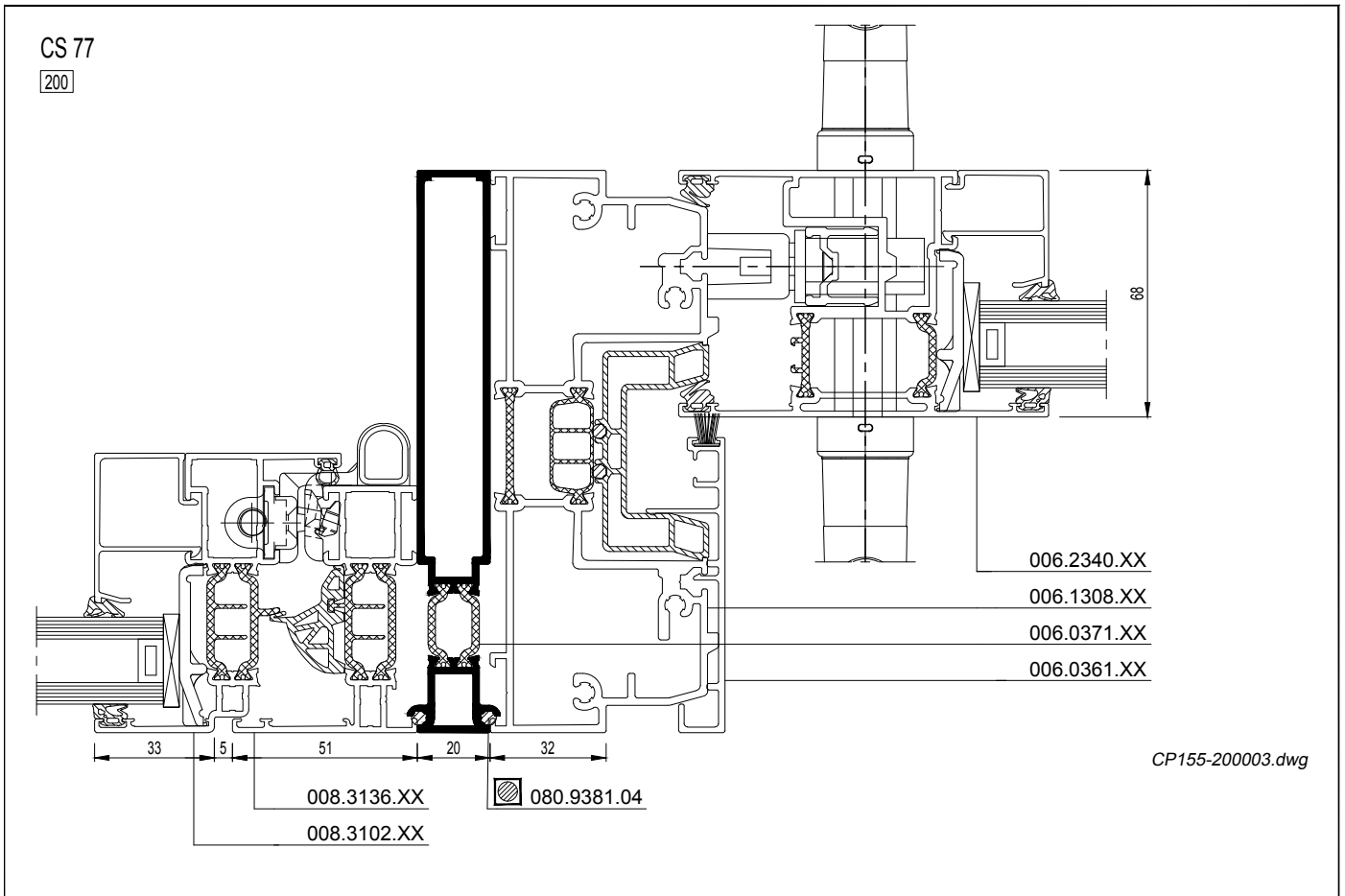
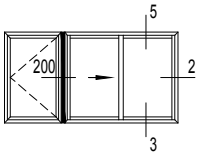

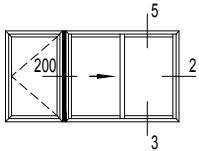

SL 38

200

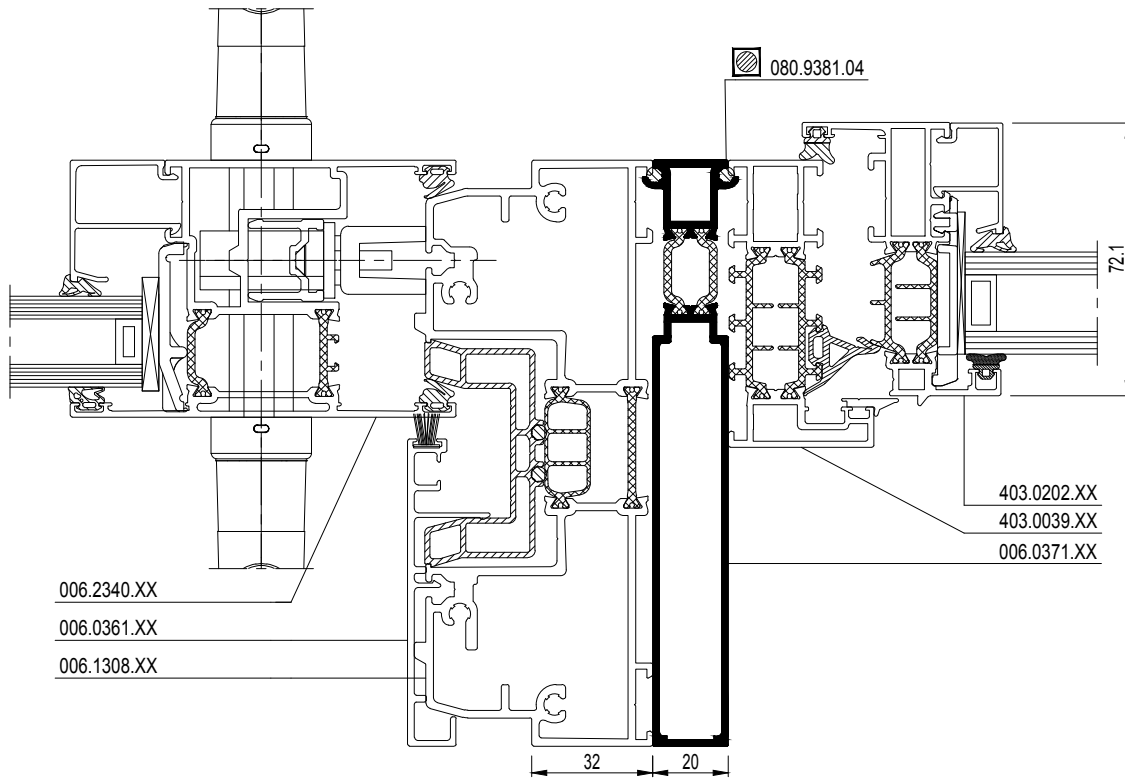

CP155-200011.dwg

SL 38

200

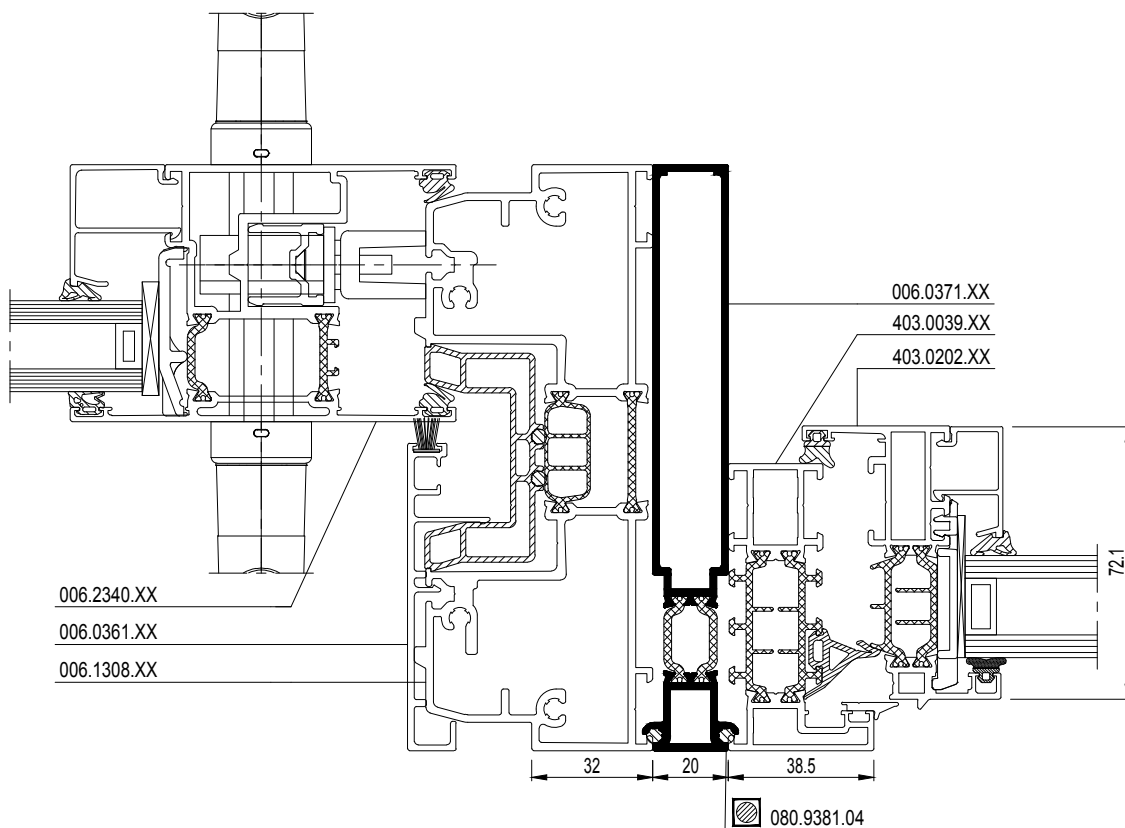

CP155-200012.dwg

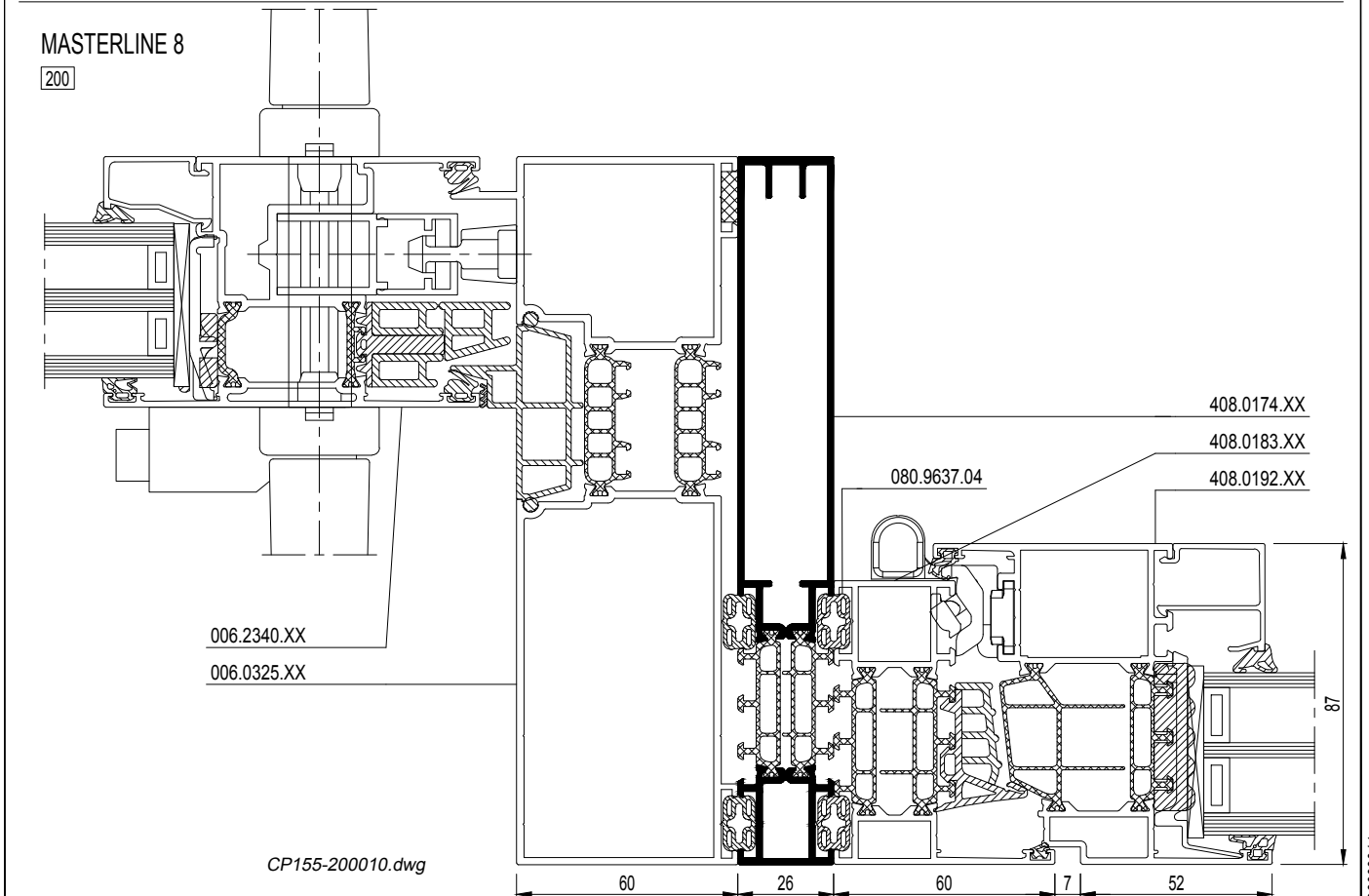
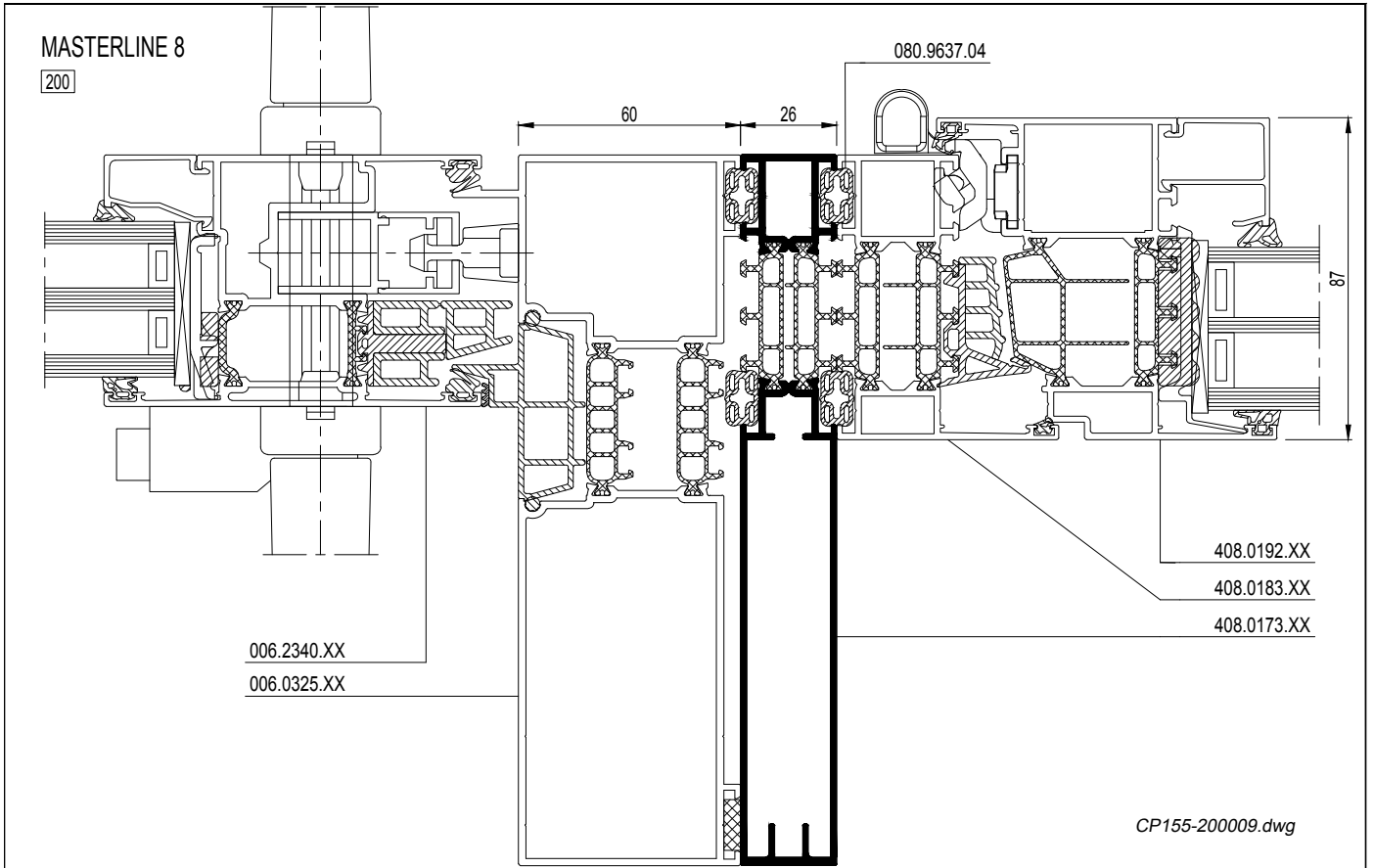
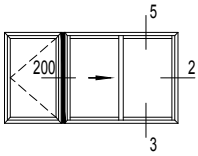

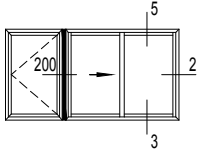

MASTERLINE 8

200

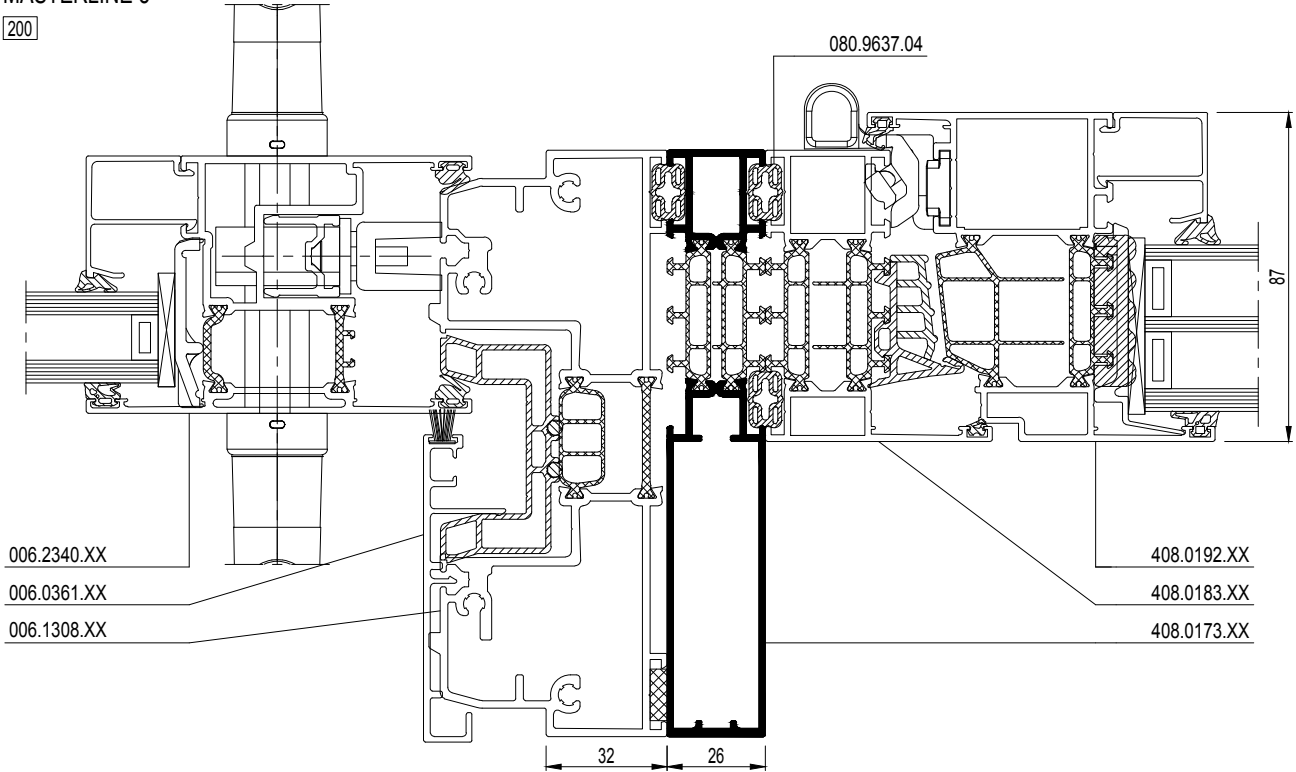

CP155-200007.dwg

MASTERLINE 8

200

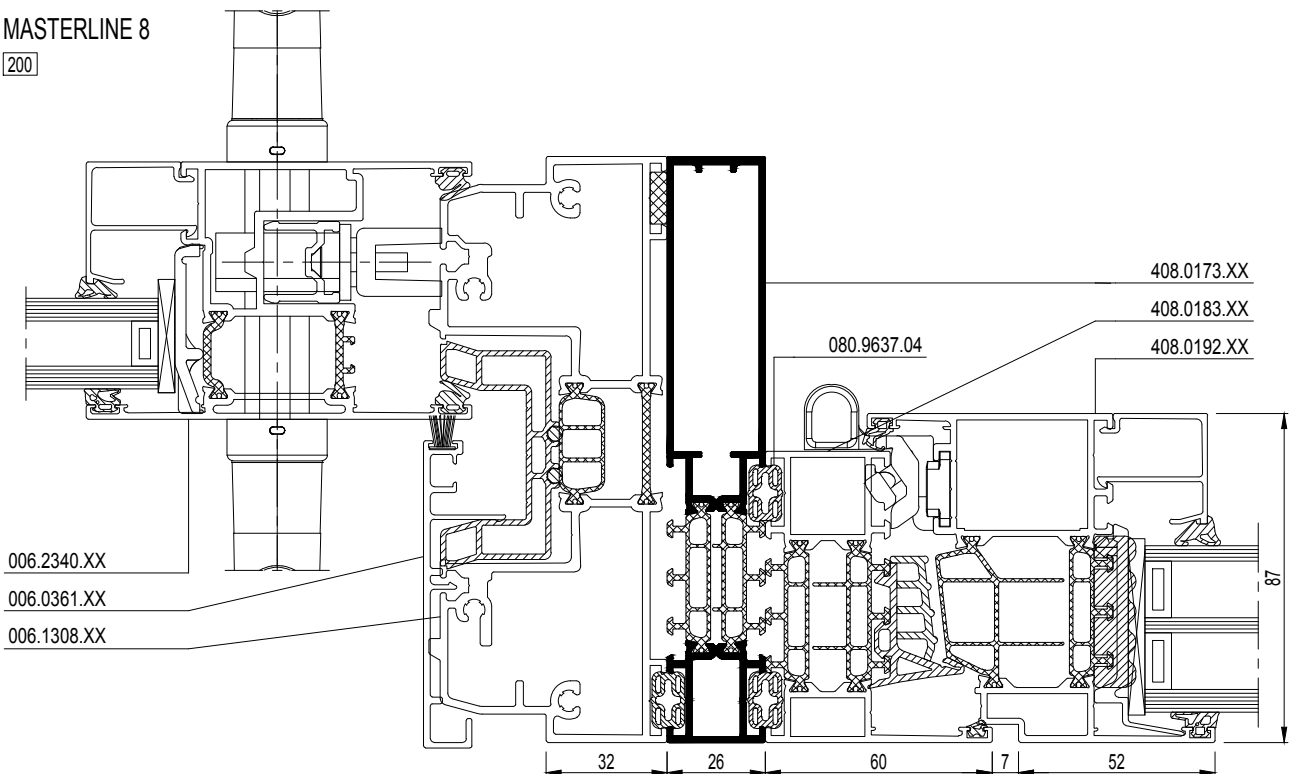

CP155-200008.dwg

CP 155-LS/HI

KOPPELINGEN MET ANDERE SYSTEMEN - MASTERLINE 10
 COMBINAISONS AVEC D'AUTRES SYSTEMES - MASTERLINE 10
 CONNECTIONS WITH OTHER SYSTEMS - MASTERLINE 10
 KOMBINATIONEN MIT ANDEREN SYSTEMEN - MASTERLINE 10

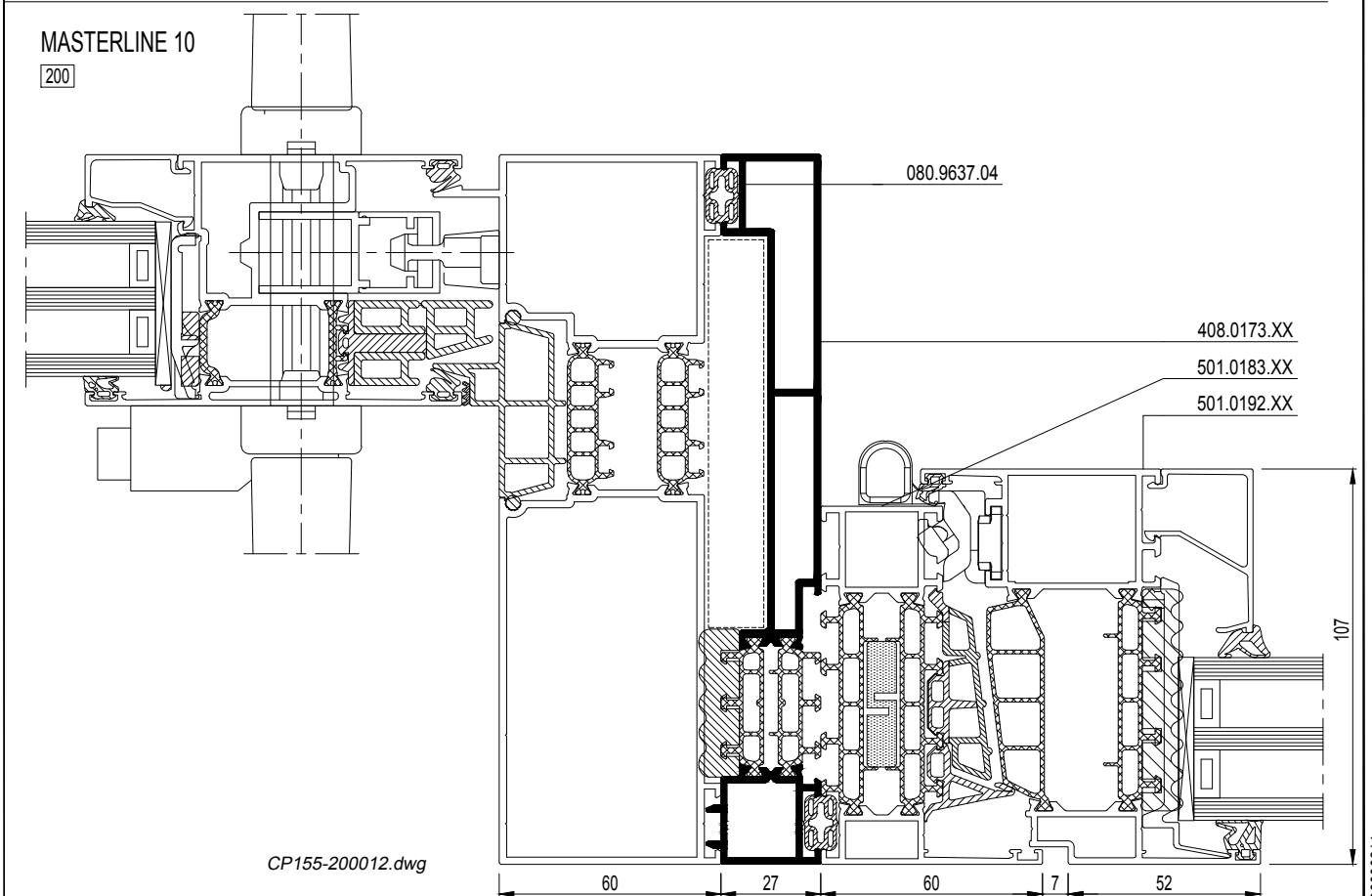
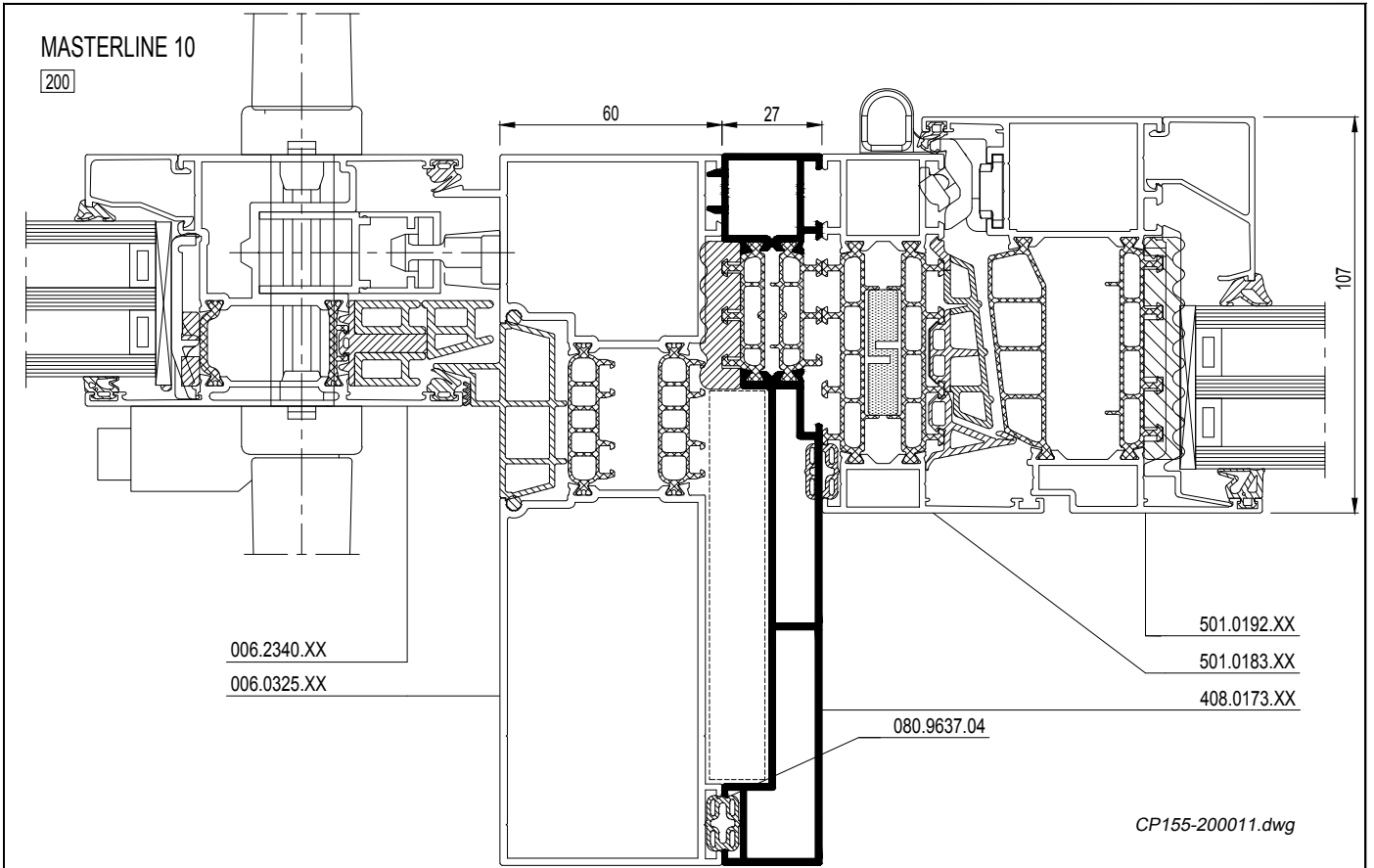
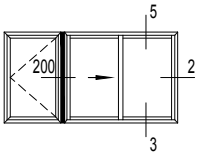

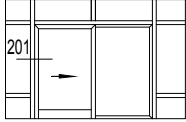

CW 50

201

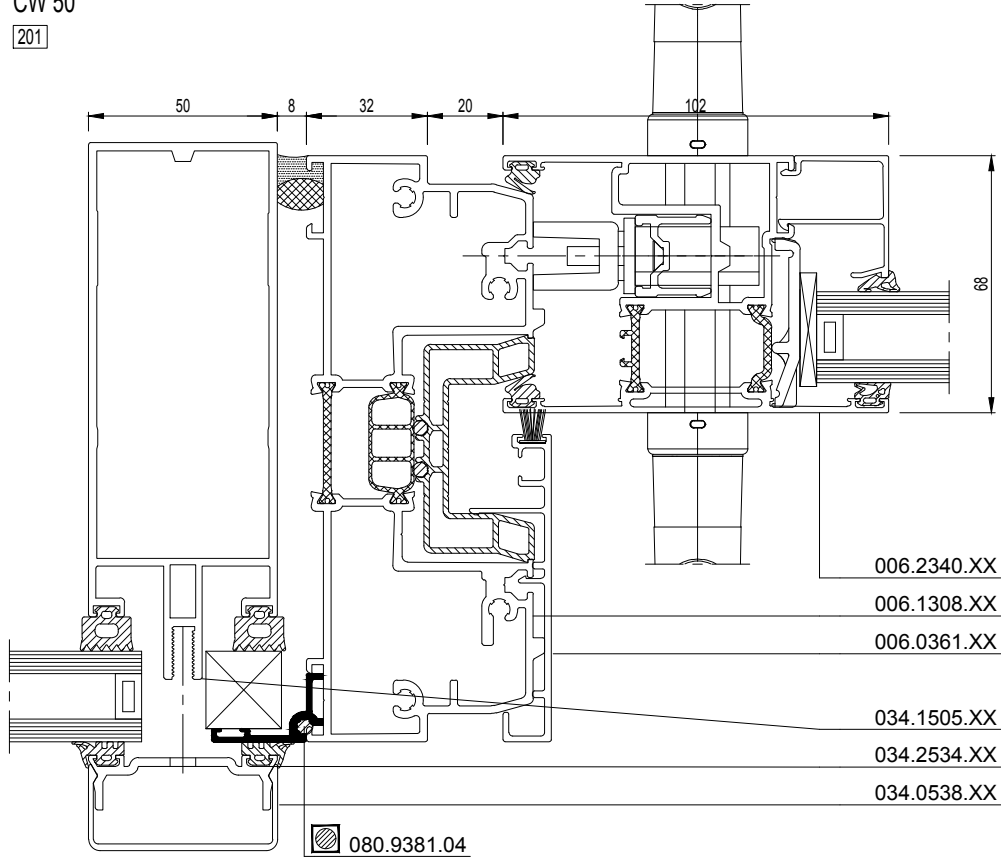

CP155-201001.dwg



www.reynaers.com